

The speed of lights



From Aromas, we travel with the speed of our lights to hundreds of countries, places and projects, getting to know their cultures, projects and illusions. It is a pleasure to collaborate with all of you to make aromas a real project every day.

Desde Aromas, viajamos con la velocidad de nuestras luces a cientos de países, lugares y proyectos, conociendo sus culturas, proyectos e ilusiones. Es un placer colaborar con todos vosotros para hacer de aromas un proyecto real cada día.

In Aromas del Campo we began our journey as a company in 1986, in Valencia. At that time our specialty was the manufacturing of potpourris of dried flowers and aromatic products. A few years later we started to make small glass table lamps filled with dried flowers. Since then, and once consolidated in the lighting sector, we moved our activity to the town of Bétera (Valencia), where we centralized production and international distribution of our lighting products.

We bet on technological design, functional and affordable lamps, with pure and simple lines but without neglecting the forms of Aromas. In this collection we focus on traditionally relegated materials to the construction finishes and decorative complements, such as marble, wood or ceramic. However, our main materials continue to be metal and glass, combined in a diversion of solidity and lightness that results in elegant and timeless pieces.

En Aromas del Campo comenzamos nuestra andadura como sociedad en 1986, en Valencia. En aquel entonces nuestra especialidad era la fabricación de potpourris de flores secas y productos aromáticos. Unos años más tarde comenzamos a fabricar pequeños sobremesas de cristal rellenos de flores secas. Desde entonces, y una vez consolidados en el sector de la iluminación, trasladamos nuestra actividad a la población de Bétera (Valencia), desde donde centralizamos la producción y distribución internacional de nuestros productos de iluminación.

Apostamos por un diseño tecnológico, funcional y asequible, con líneas puras y sencillas pero sin descuidar la forma. En esta colección ponemos el foco en materiales tradicionalmente relegados a los acabados constructivos y a los complementos de la decoración, como son el mármol, la madera o la cerámica. Sin embargo, nuestros materiales principales continúan siendo el metal y el cristal combinados en un juego de solidez y ligereza que resulta en piezas elegantes y atemporales.



- 02 **Table lamps**
Lámparas de sobremesa · 6
- 03 **Pendant Lamps**
Lámparas colgantes · 106
- 04 **Floor Lamps**
Lámparas de pie · 262
- 05 **Wall Lamps**
Appliques · 304
- 06 **Accessories**
Accesorios · 412
- 07 **Bulbs**
Bombillas · 418
- 08 **Finishes**
Acabados · 426
- 09 **General Information**
Información General · 430



Table

Lamps

8	TURA · S1313	56	DAMO · S1191
10	DOUL · S1310	58	BOA · S1193
12	TANA · S1309	59	LALU · S1189
14	DUSSA · S1307	60	MILA · S1183
16	BION · S1306	62	HEDRA · S1159
18	BALLY · S1305	63	STAN · S1154
20	FILA · S1304	64	ENDO · S1156
21	ICONIC · S1300	66	HEDULA · S1150
22	YCRO · S1297	67	SAND · S1109
24	ISON · S1298	68	ALDA · S1108
25	NANO · S1294	70	CAND · S1107
26	PIPE · S1293	72	ONA · S1029
27	PORTA · S1290	73	TEX · S1026
28	PORTA-L · S1290/L	74	ONUT · NAC130
29	AMBOR · S1283	76	BORA · NAC129
30	KINE · S1288	78	TILLA · NAC128
31	FITO · S1286	80	DAB · NAC127
32	ATIL · S1281	82	BABEL · NAC126
33	FOCUS · S1279	83	GOT · NAC125
34	NOOI · S1276	84	COPO · NAC124
36	NINO · S1275	85	AGRA · NAC123
37	LYB · S1274	86	ENA · NAC121
38	AITO · S1270	88	ADON · NAC119
39	SHIN · S1261	89	HOME · NAC118
40	ABBACUS · S1258	90	METRIC · NAC117
41	ERTO · S1257	91	SONICA · NAC116 · NAC114
42	MAHO · S1254	94	ATINA · NAC115
44	FICUS · S1243	95	TARO · NAC113
45	ALOA · S1240 · S1227	96	SHADOW · NAC112
46	LUCA · S1237	97	NOA · NAC110
47	LOLA · S1232	98	PONN PONN · NAC109
48	NERA · S1229	100	KITTA KITTA · NAC108
50	LITA · S1230	101	KITTA PONN · NAC107
51	LIND · S1220 · S1220/USB	102	PONN · NAC106
52	ATOM · S1214	103	LUSA · NAC104
53	DOBI · S1207	104	MELLY · NAC103
54	COHEN · S1196	105	SAM · NAC093
55	MARU · S1194		



TURA

S1313

Designed b JF Sevilla, 2023

DESCRIPTION

MATERIALS

Steel / Leather / Marble

FINISHES

Steel:

Matt black

Leather:

Black / Brown / Orange

Marble:

Matt Black

SPECIFICATIONS

Chip LED 5W 2700K, Dimmable

Dimmer on cable

24V - 50/60 Hz

IP20 - Class II

ENERGY LABEL

A ++



MATERIALES

Metal / Cuero / Mármol

ACABADOS

Metal:

Negro mate

Cuero:

Negro / Marrón / Naranja

Mármol:

Negro mate

ESPECIFICACIONES

Chip LED 5W 2700K, Regulable

Regulador en cable

24V, 50/60 Hz

IP20, Clase II

ETIQUETA ENERGÉTICA

A ++

TECHNICAL

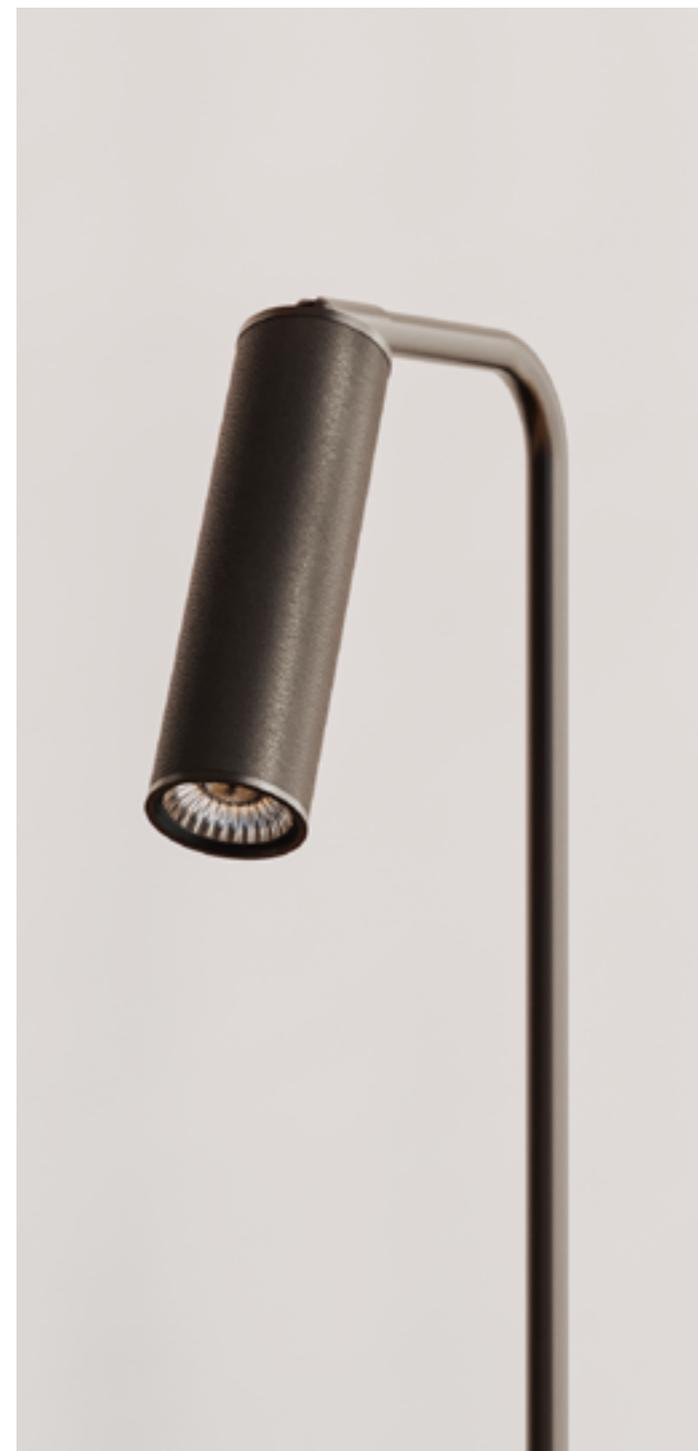
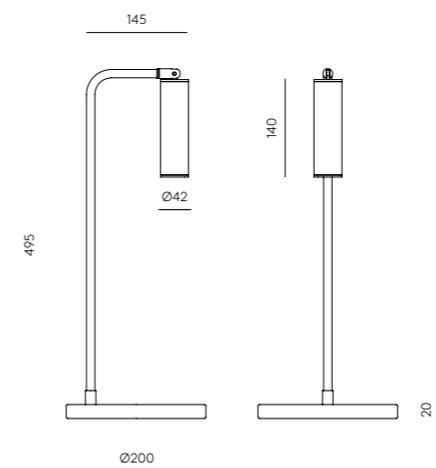

DOUL

S1310

Designed by Agus Gascón, 2023

DESCRIPTION

MATERIALS
Steel / Glass

FINISHES

Body:
Matt black / Aged gold

Glass:
Striped glass - Transparent

SPECIFICATIONS (UE)

G4 LEDs 3W 2700K
Dimmable (Included)
Regulation on cable
220-240V, 50/60Hz
IP20, Class II

ENERGY LABEL

A ++

MATERIALES
Metal / Vidrio

ACABADOS

Cuerpo: Negro mate /
Oro envejecido

Cristal: Cristal rayado - Trans-
parente

ESPECIFICACIONES (UE)

G4 LED 3W 2700K
Regulable (Incluida)
Regulación en cable
220-240 V, 50/60 Hz
IP20, Clase II

ETIQUETA ENERGÉTICA

A ++

IP20 CE

TECHNICAL

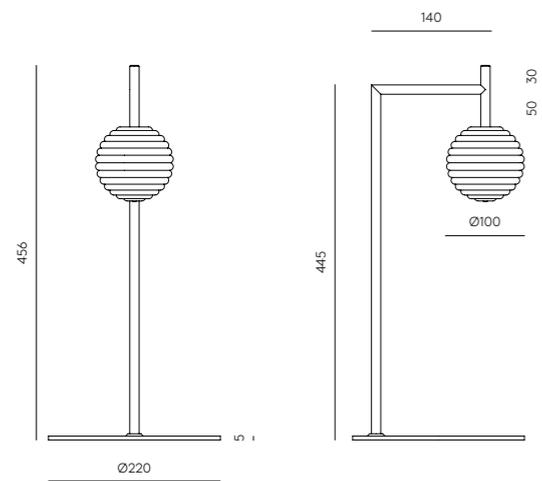



Kyoto, Japan

TANA

S1309

Designed by JF Sevilla, 2022

DESCRIPTION

MATERIALS

Steel

FINISHES

Steel:
Matt black

SPECIFICATIONS

Chip LED 4W - 2700K
(Included)
Dimmer on cable
220-240V - 24V - 50/60 Hz
IP20 - Class I

ENERGY LABEL

A ++

MATERIALES

Metal

ACABADOS

Metal:
Negro mate

ESPECIFICACIONES

Chip LED 4W - 2700K (Incluida)
Regulador en cable
220-240V - 24V - 50/60 Hz
IP20 - Clase I

ETIQUETA ENERGÉTICA

A ++

IP20    

TECHNICAL

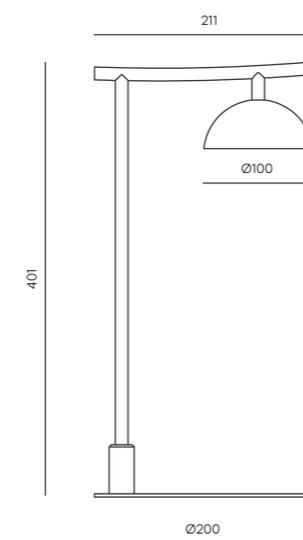

DUSSA

Table lamp

S1307

Designed by Pepe Fornas, 2022

DESCRIPTION

MATERIALS
Steel / Marble

FINISHES

Steel:
Matt black
Aged gold

Marble:

Black
White
Travertine

SPECIFICATIONS

Led Plate 9W 2700K
Dimmer on cable
24 V, 50/60 Hz
IP20 - Class II

ENERGY LABEL

A ++

MATERIALES
Acero / Mármol

ACABADOS

Metal:
Negro mate
Oro envejecido

Mármol:

Negro
Blanco
Travertino

ESPECIFICACIONES

Placa LED 9W - 2700K
Regulador en cable
24 V, 50/60 Hz
IP20, Clase II

ETIQUETA ENERGÉTICA

A ++

IP20 CE RoHS A++

TECHNICAL

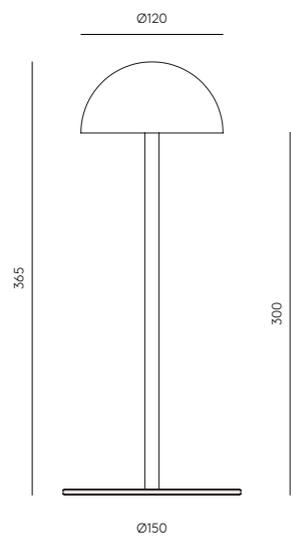

Helsinki, Finland

Sofia, Bulgaria

BION

Table lamp

S1306

Designed by Pepe Fornas, 2022

DESCRIPTION

MATERIALS
Steel / Marble

FINISHES
Body:
Matt black
Aged gold

Shade:
Matt black
Matt white

Base:
Matt black marble

SPECIFICATIONS
G9 LED 5W 2700K
Dimmable (Included)
Dimmer on cable
220-240 V, 50/60 Hz
IP20, Class II

ENERGY LABEL
A ++

IP20 CE RoHS RECYCLED

MATERIALES
Acero / Mármol

ACABADOS
Cuerpo:
Negro mate
Oro envejecido

Tulipa:
Negro mate
Blanco mate

Base:
Mármol negro mate

ESPECIFICACIONES
G9 LED 5W 2700K
Regulable (Incluida)
Regulación en cable
220-240 V, 50/60 Hz
IP20, Clase II

ETIQUETA ENERGÉTICA
A ++

TECHNICAL

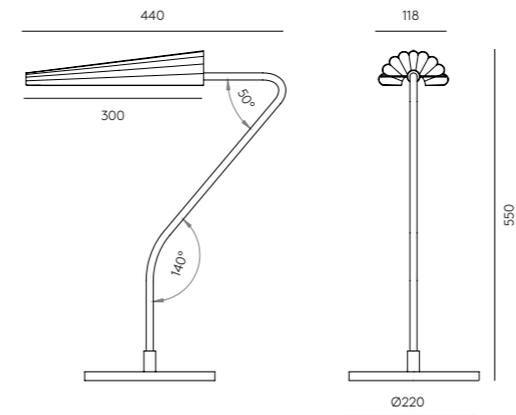

BALLY

Table lamp

S1305

Designed by AC Studio, 2022

DESCRIPTION

MATERIALS

Glass/ Steel /
Synthetic leather

FINISHES

Steel:
Matt black

Glass:
curly transparent

Synthetic leather:
Brown

SPECIFICATIONS

Dimmable Led Chip (Included)
5W, 3000K
5V/A 9600mAh battery
50/60Hz
IP20 - Class III
Touch me - Dimmable
Portable and rechargeable
Charger and cable included

ENERGY LABEL

A ++

IP20 CE RoHS REACH A++

MATERIALES

Vidrio / Metal /
Cuero Sintético

ACABADOS

Metal:
Negro Mate

Vidrio:
Transparente rizado

Cuero Sintético:
Marrón

ESPECIFICACIONES

Chip Led regulable (Incluido)
5W, 3000K
5V/A Bateria 9600mAh
50/60 Hz
IP20 - Clase III
Touch me - Regulable
Portatil y recargable
Cargador y cable incluido

ETIQUETA ENERGÉTICA

A ++

TECHNICAL

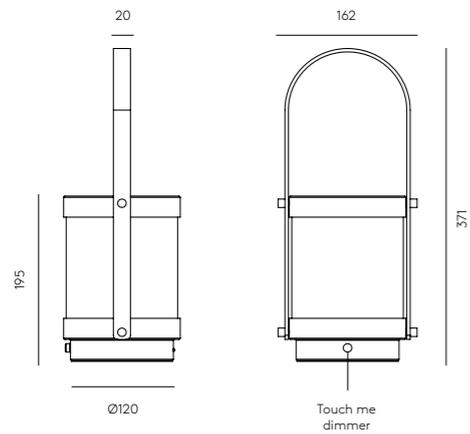

FILA

Table lamp

S1304

Designed by AC Studio, 2022

DESCRIPTION

MATERIALS

Steel

FINISHES

Base:
Matt black

Shade:
Matt brass
Matt white

Body:
Matt brass

SPECIFICATIONS (UE)

Portable lamp, Type C Charger
Led Max. 3W, 3000K, 300lm
Touch-me dimmer switch2
Core USB-C cord 1000mm
Lithium Battery 4800mHa
IP20 - Clase III

ENERGY LABEL

A ++



MATERIALES

Acero

ACABADOS

Base:
Negro Mate

Tulipa:
Oro mate
Blanco mate

Cuerpo:
Oro mate

ESPECIFICACIONES (UE)

Lámpara portátil, cargador tipo C
Led Max. 3W, 3000K, 300lm
Touch-me dimmer switch2
Cable Core USB-C 1000mm
Batería de litio 4800mHa
IP20 - Clase III

ETIQUETA ENERGÉTICA

A ++

TECHNICAL

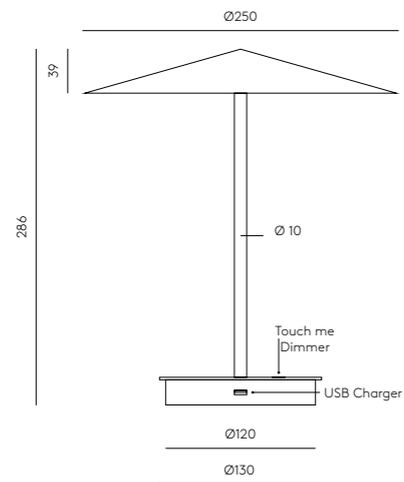

ICONIC

Table lamp

S1300

Designed by Agus Gascón, 2022

DESCRIPTION

MATERIALS

Steel / Marble

FINISHES

Metal:
Matt black
Matt Brass

Marble:
Finnish Marble

SPECIFICATIONS (UE)

COB Led 7W 2700K Dimmable
220-240V - 24V - 50/60 Hz
IP20 - Clase II

ENERGY LABEL

A ++



MATERIALES

Acero / Mármol

ACABADOS

Metal:
Negro Mate
Oro Mate

Mármol:
Finlandés

ESPECIFICACIONES (UE)

Placa Led 7W 2700K Regulable
220-240V - 24V - 50/60 Hz
IP20 - Clase II

ETIQUETA ENERGÉTICA

A ++

TECHNICAL

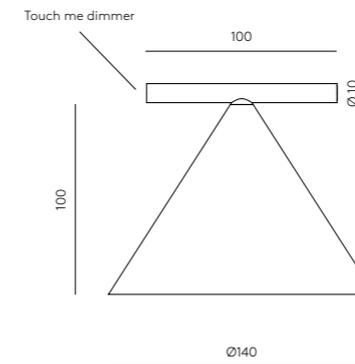

Brussels, Belgium



YCRO

Table lamp

S1297

Designed by JF Sevilla, 2022

DESCRIPTION

MATERIALS
Steel / Marble

FINISHES
Metal:
Matt black
Matt Brass
Marble:
Matt Black

SPECIFICATIONS (UE)
Chip Led 8W 3000K Dimmable
220-240V - 24V - 50/60 Hz
IP20 - Class II

ENERGY LABEL
A ++

MATERIALES
Acero / Mármol

ACABADOS
Metal:
Negro Mate
Oro Mate
Mármol:
Negro Mate

ESPECIFICACIONES (UE)
Chip Led 8W 3000K Regulable
220-240V - 24V - 50/60 Hz
IP20 - Clase II

ETIQUETA ENERGÉTICA
A ++

IP20 CE RoHS A++

TECHNICAL

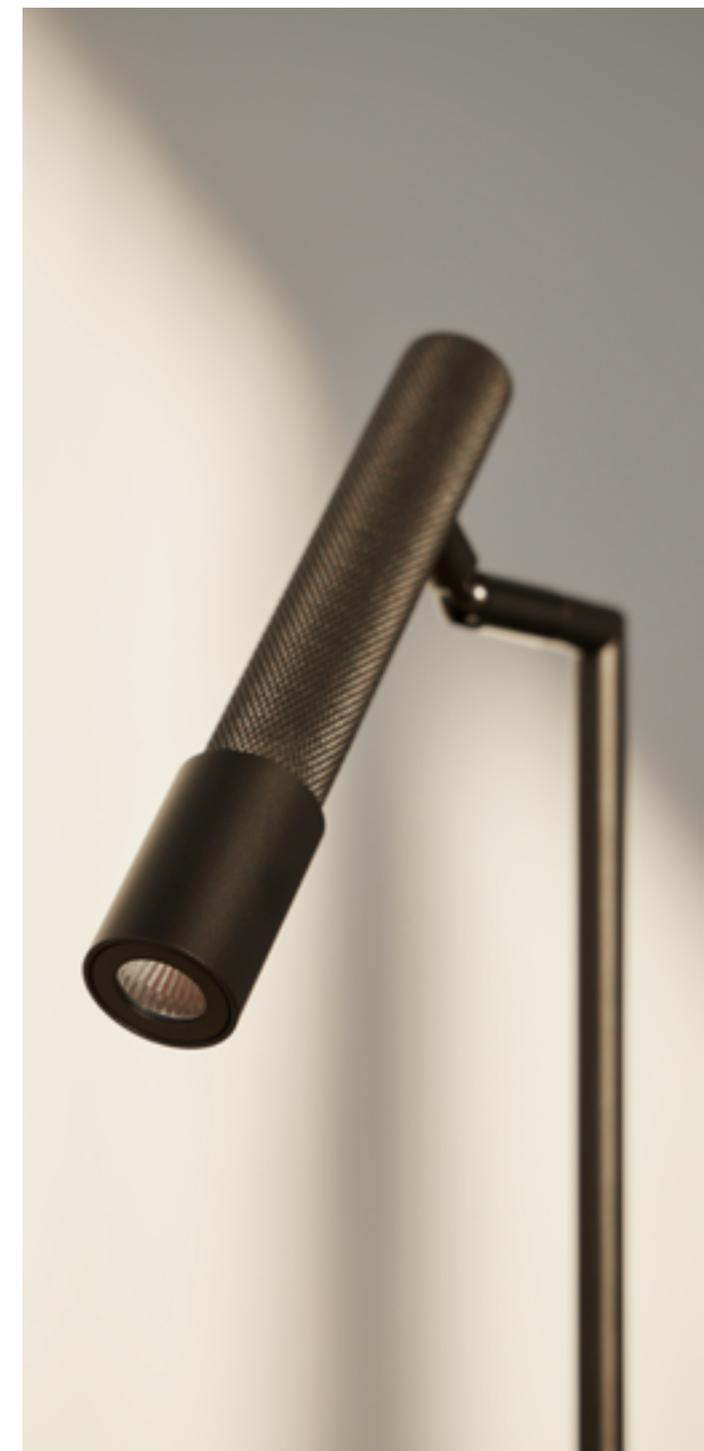
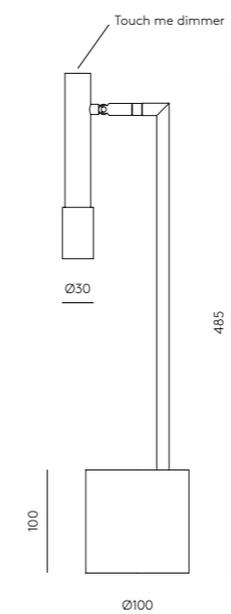

ISON

Table lamp

S1298

Designed by Pepe Fornas, 2022

DESCRIPTION

MATERIALS

Steel / Glass

FINISHES

Metal:
Aged Gold
Matt Black

Glass:
Fluted glass

SPECIFICATIONS (UE)

LED Strip 6W 2700K Dimmable
220-240V - 24V - 50/60 Hz
IP20 - Class II

ENERGY LABEL

A ++

IP20 CE RoHS A++

MATERIALES

Acero / Vidrio

ACABADOS

Metal:
Oro envejecido
Negro Mate

Vidrio:
Estriado

ESPECIFICACIONES (UE)

Tira LED 6W 2700K Regulable
220-240V - 24V - 50/60 Hz
IP20 - Clase II

ETIQUETA ENERGÉTICA

A ++

TECHNICAL

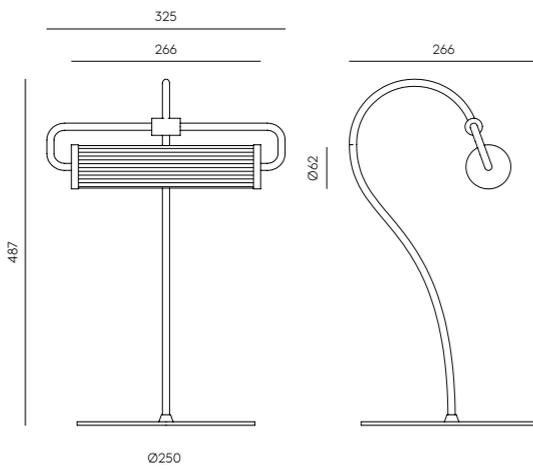

NANO

Table lamp

S1294

Designed by Agus Gascón, 2020

DESCRIPTION

MATERIALS

Steel / Marble / Glass

FINISHES

Metal:
Matt Brass

Marble:
Matt Black

Glass:
Opal

SPECIFICATIONS (UE)

COB LED 3W, 3000K
3,7V 2000 mAh 50/60 Hz
IP20, Class III
Touch me - Dimmable
Portable and rechargeable
Wireless charger and USB
included

ENERGY LABEL

A ++

IP20 CE RoHS A++

MATERIALES

Acero / Mármol / Vidrio

ACABADOS

Metal:
Oro mate

Mármol:
Negro mate

Vidrio:
Opal

ESPECIFICACIONES (UE)

COB LED 3W, 3000K
3,7V 2000 mAh 50/60 Hz
IP20, Clase III
Touch me - Regulable
Portátil y recargable
Base de carga inalámbrica y usb
incluidos

ETIQUETA ENERGÉTICA

A ++

TECHNICAL

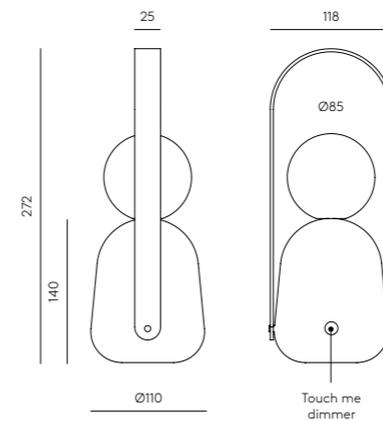

PIPE

Table lamp

S1293

Designed by AC Studio, 2021

DESCRIPTION

MATERIALS

Steel

FINISHES

Metal:
Matt Black

SPECIFICATIONS (UE)

GU10 LED 3W 3000K dimmable
220-240 V, 50/60 Hz
Dimmer switch on cable
IP20, Class II

ENERGY LABEL

A ++



MATERIALES

Acero

ACABADOS

Metal:
Negro mate

ESPECIFICACIONES (UE)

GU10 LED 3W 3000K regulable
(incluida), 220-240 V, 50/60 Hz
Regulador en cable
IP20, Clase II

ETIQUETA ENERGÉTICA

A ++

TECHNICAL

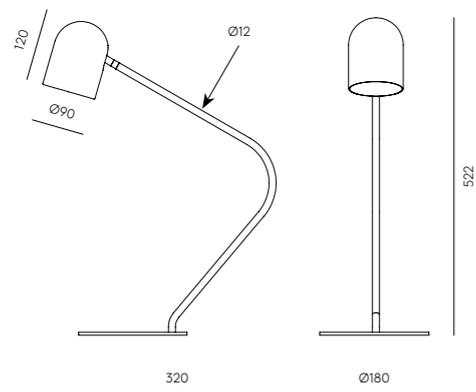

PORTA

Table lamp

S1290

Designed by Estudi Hac, 2021

DESCRIPTION

MATERIALS

Steel / Glass

FINISHES

Metal:
Matt Black
Glass:
Smoked grey

SPECIFICATIONS (UE)

9W LED Plate
2700K Dimmable
24 V, 50/60 Hz
IP20, Class II

ENERGY LABEL

A ++



MATERIALES

Acero / Vidrio

ACABADOS

Metal:
Negro mate
Vidrio:
Gris ahumado

ESPECIFICACIONES (UE)

Placa LED 9W
2700K Regulable
24 V, 50/60 Hz
IP20, Clase II

ETIQUETA ENERGÉTICA

A ++

TECHNICAL

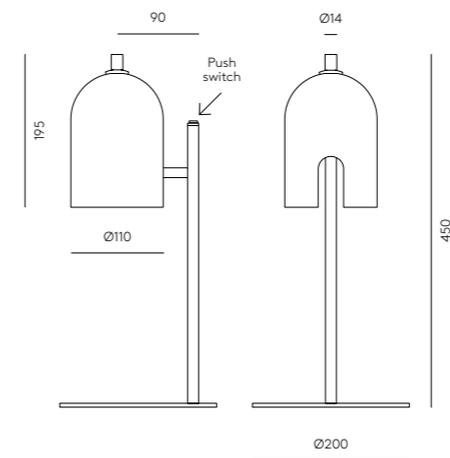

PORTA-L

Table lamp

S1290/L

Designed by Estudi Hac, 2021

DESCRIPTION

MATERIALS

Steel / Glass

FINISHES

Metal:
Matt Black

Glass:
Smoked grey

SPECIFICATIONS (UE)

9W LED Plate
2700K Dimmable
Dimmer switch on cable
24 V, 50/60 Hz
IP20, Class II

ENERGY LABEL

A ++

IP20 CE 

MATERIALES

Acero / Vidrio

ACABADOS

Metal:
Negro mate

Vidrio:
Gris ahumado

ESPECIFICACIONES (UE)

Placa LED 9W
2700K Regulable
Regulador en cable
24 V, 50/60 Hz
IP20, Clase II

ETIQUETA ENERGÉTICA

A ++

TECHNICAL

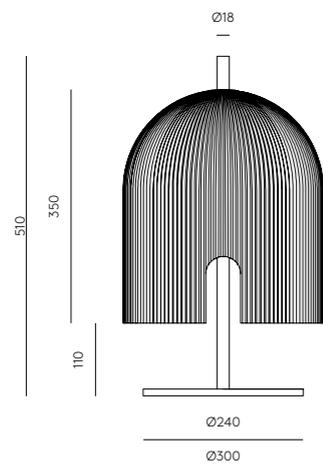

AMBOR

Table lamp

S1283

Designed by JF Sevilla, 2019

DESCRIPTION

MATERIALS

Steel

FINISHES

Body:
Matt Black

Base/Shade:
Matt Brass
Matt Black

BULBS INCLUDED

B005/3W/REG

SPECIFICATIONS (UE)

G9 Led Dimmable Bulbs
(Incl.) 2 x 3W - 3000K
220-240 V, 50/60 Hz
IP20, Class II
Dimmer on cable

ENERGY LABEL

A ++

IP20 CE 

MATERIALES

Acero

ACABADOS

Cuerpo:
Negro mate

Base/Pantalla:
Oro mate
Negro mate

BOMBILLAS INCLUIDAS

B005/3W/REG

ESPECIFICACIONES (UE)

Bombillas G9 Led Regulables
(Incl.) 2 x 3W - 3000K
220-240 V, 50/60 Hz
IP20, Clase II
Regulador en cable

ETIQUETA ENERGÉTICA

A ++

TECHNICAL

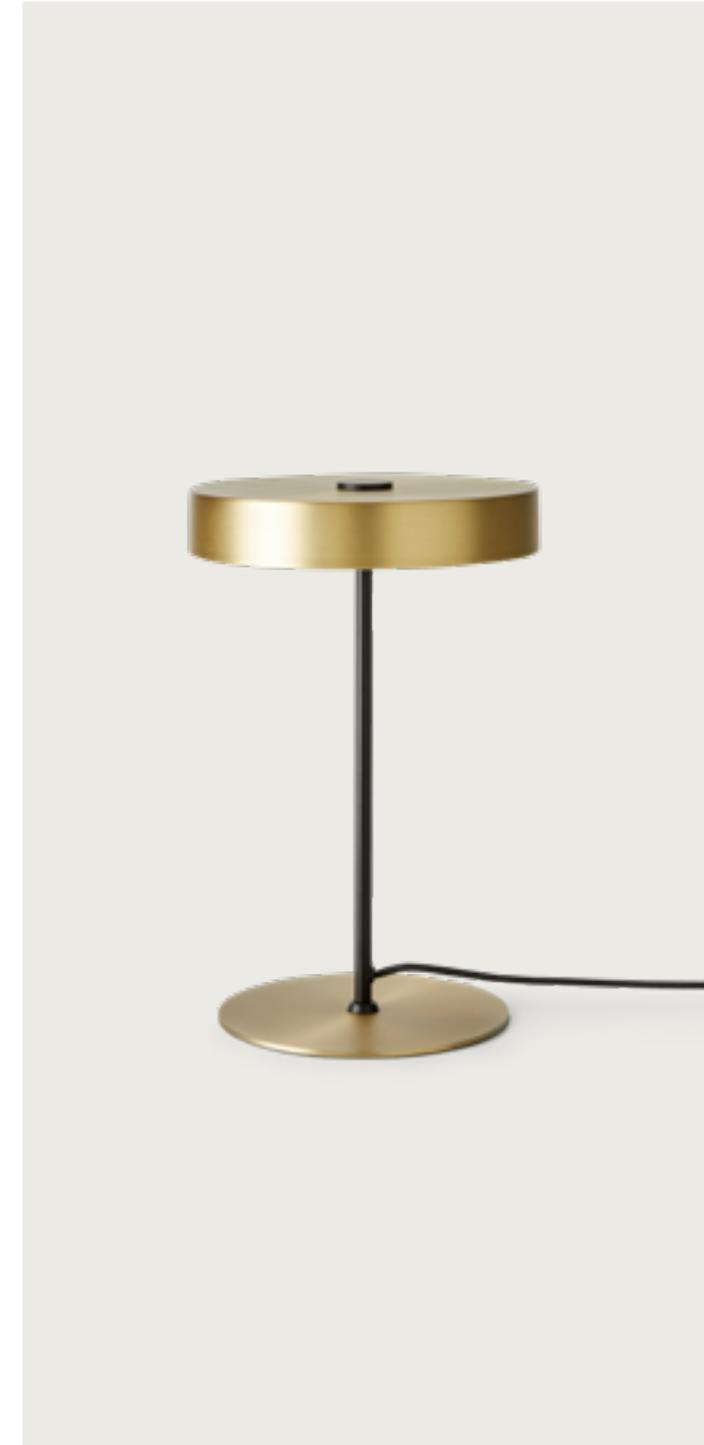
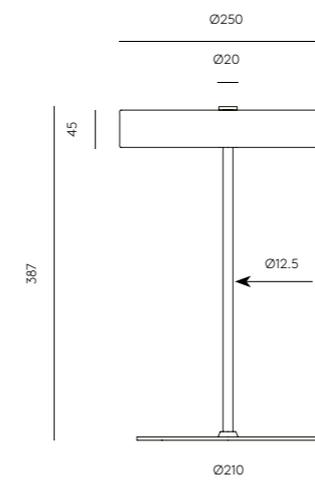

KINE

Table lamp

S1288

Designed by Pepe Fornas, 2020

DESCRIPTION

MATERIALS

Steel/Marble

FINISHES

Base:
Matt Black Marble
Matt White Marble

Shade:

Textured Black
Textured White
Matt Brass

SPECIFICATIONS (UE)

Integrated LED plate 10W
2700K 24V, 50 / 60Hz
IP20, Class II
Touch Me Dimmer

ENERGY LABEL

A ++

IP20 CE RoHS A++

MATERIALES

Acero / Mármol

ACABADOS

Base:
Mármol negro mate
Mármol blanco mate

Tulipa:

Negro texturado
Blanco texturado
Oro mate

ESPECIFICACIONES (UE)

Placa LED integrada 10W
2700K 24V, 50/60Hz
IP20, Clase II
Touch Me Regulable

ETIQUETA ENERGÉTICA

A ++

TECHNICAL

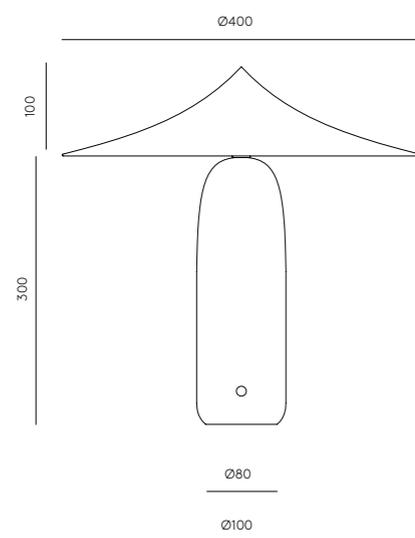

FITO

Table lamp

S1286

Designed by Pepe Fornas, 2020

DESCRIPTION

MATERIALS

Steel

FINISHES

Base: Matt Brass
Shade:
Matt Black
Matt White

OPTIONS

50 cm shade, ask for height

SPECIFICATIONS (UE)

E27 (Bulb not included)
220-240 V, 50/60 Hz
IP20, Class II
Dimmer on cable

ENERGY LABEL

A ++

IP20 CE RoHS A++

MATERIALES

Acero

ACABADOS

Base: Oro Mate
Tulipa:
Blanco Mate
Negro Mate

OPCIONES

Pantalla 50 cm, altura consultar

ESPECIFICACIONES (UE)

E27 (Bombilla no incluida)
220-240 V, 50/60 Hz
IP20, Clase II
Regulador en cable

ETIQUETA ENERGÉTICA

A ++

TECHNICAL

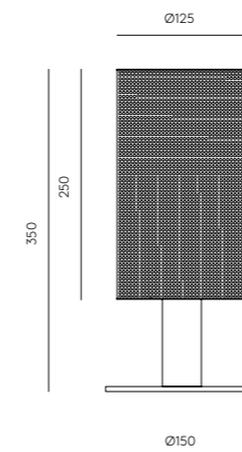

ATIL

Table lamp

S1281

Designed by Pepe Fornas, 2019

DESCRIPTION

MATERIALS

Steel

FINISHES

Metal:
Matt Black
Matt Brass

Glass:
Opal

SPECIFICATIONS (UE)

Bulbs G9 Led (Included)
2 x 5W - 2700K
220-240 V, 50/60 Hz
IP20, Class II

ENERGY LABEL

A ++

BULBS INCLUDED

B005/5W

IP20 CE    

MATERIALES

Acero

ACABADOS

Metal:
Negro mate
Oro mate

Vidrio:
Opal

ESPECIFICACIONES (UE)

Bombillas G9 Led (Incluidas)
2 x 5W - 2700K
220-240 V, 50/60 Hz
IP20, Clase II

ETIQUETA ENERGÉTICA

A ++

BOMBILLAS INCLUIDAS

B005/5W

TECHNICAL

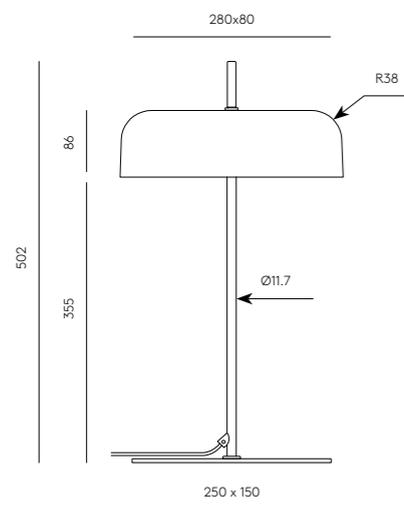

FOCUS

Table lamp

S1279

Designed by Pepe Fornas, 2019

DESCRIPTION

MATERIALS

Steel / Aluminium

FINISHES

Body:
Matt Black

Head:
Aged gold
Anthracite
Alabaster

POSSIBLE MODIFICATIONS

Alabaster head extra charge

SPECIFICATIONS (UE)

GU10 Led Bulb (Included)
5W - 2700K
220-240 V, 50/60 Hz
IP20, Class II

ENERGY LABEL

A ++

IP20 CE    

MATERIALES

Acero / Aluminium

ACABADOS

Cuerpo:
Negro mate

Cabezal:
Oro envejecido
Antracita
Alabastro

MODIFICACIONES POSIBLES

Cabezal de alabastro coste extra

ESPECIFICACIONES (UE)

Bombilla GU10 Led (Incluida)
5W - 2700K
220-240 V, 50/60 Hz
IP20, Clase II

ETIQUETA ENERGÉTICA

A ++

TECHNICAL

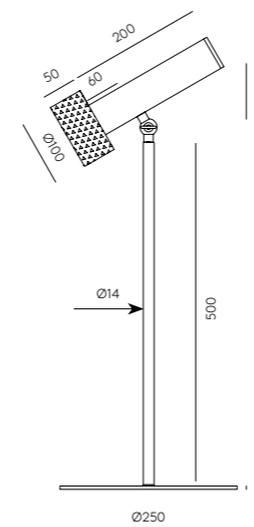

NOOI

S1276

Designed by Pepe Fornas, 2022

DESCRIPTION

MATERIALS

Linen / Steel / Acrylic

FINISHES

Metal:
Matt Black

Shade:
Cream Linen textile

Acrylic:
Opal

SPECIFICATIONS (UE)

T8 5W - 3000K
Dimmer on cable
220-240 V, 50/60 Hz
IP20, Class II

ENERGY LABEL

A ++

IP20 CE    

MATERIALES

Lino / Metal / Acrílico

ACABADOS

Metal:
Negro mate

Tulipa:
Textil Lino Crema

Acrílico:
Opal

ESPECIFICACIONES (UE)

T8 5W - 3000K
Regulador en cable
220-240 V, 50/60 Hz
IP20, Clase II

ETIQUETA ENERGÉTICA

A ++

TECHNICAL

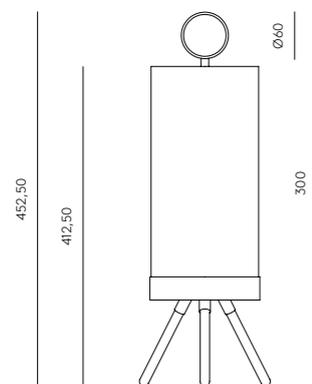
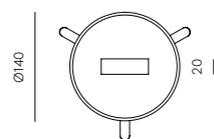

NINO

Table lamp

S1275

Designed by JF Sevilla, 2021

DESCRIPTION

MATERIALS

Steel / Marble / Glass

FINISHES

Metal:
Matt Black

Details:
Matt Brass

Marble:
Matt Black

Glass:
Optic

SPECIFICATIONS (UE)

LED 7W
2700K Dimmable
24 V, 50/60 Hz,
IP20, Class II
Touch me dimmer

ENERGY LABEL

A ++



MATERIALES

Acero / Mármol / Vidrio

ACABADOS

Metal:
Negro mate

Detalles:
Oro mate

Mármol:
Matt Black

Vidrio:
Óptico

ESPECIFICACIONES (UE)

LED 7W
2700K Regulable
24 V, 50/60 Hz,
IP20, Clase II
Touch me dimmer

ETIQUETA ENERGÉTICA

A ++



TECHNICAL

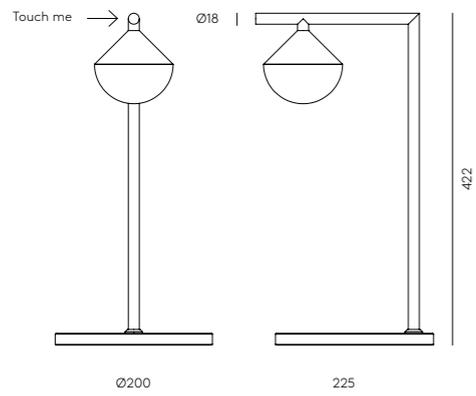

LYB

Table lamp

S1274

Designed by Pepe Fornas, 2019

DESCRIPTION

MATERIALS

Steel

FINISHES

Metal:
Matt Black

SPECIFICATIONS (UE)

Integrated LED chip 5W
3000K
12 V, 50/60 Hz
IP20, Class II
Touch me dimmer

ENERGY LABEL

A ++



MATERIALES

Acero

ACABADOS

Metal:
Negro mate

ESPECIFICACIONES (UE)

Chip Led integrado 5W,
3000K
12 V, 50/60 Hz
IP20, Clase II
Touch me dimmer

ETIQUETA ENERGÉTICA

A ++



TECHNICAL

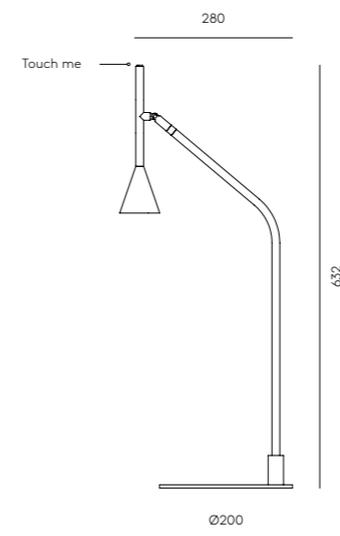

AITO

Table lamp

S1270

Designed by Pepe Fornas, 2019

DESCRIPTION

MATERIALS

Steel / Wood

FINISHES

Metal:
Matt Black

Wood:
Walnut

SPECIFICATIONS (UE)

E27 Max. 60W (Not included)
220-240 V, 50/60 Hz
IP20, Class II

ENERGY LABEL

A ++

BOMBILLA RECOMENDADA

B211 (7, 9, 11W)

IP20 CE    

MATERIALES

Acero / Madera

ACABADOS

Metal:
Negro mate

Madera:
Nogal

ESPECIFICACIONES (UE)

E27 Max. 60W (No incluida)
220-240 V, 50/60 Hz
IP20, Clase II

ETIQUETA ENERGÉTICA

A ++

RECOMMENDED BULB

B211 (7, 9, 11W)

TECHNICAL

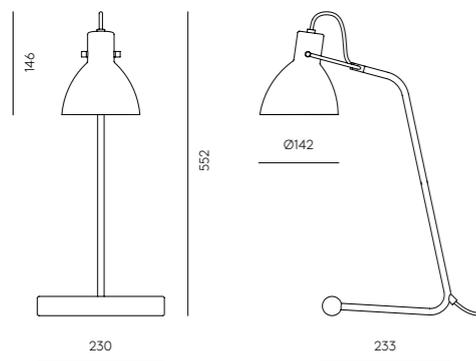

SHIN

Table lamp

S1261

Designed by Pepe Fornas, 2021

DESCRIPTION

MATERIALS

Steel / Marble

FINISHES

Marble black - Metal black
Marble white - Metal white

Shade not included
Recommended shade 801011/35

SPECIFICATIONS (UE)

E27, 5W LED Dimmable
2700k, (Included)
230V, 50/60 Hz
IP20, Class II
Touch me dimmer

ENERGY LABEL

A ++

IP20 CE    

MATERIALES

Acero / Mármol

ACABADOS

Mármol negro - Metal negro
Mármol blanco - Metal blanco

Pantalla no incluida
Pantalla recomendada 801011/35

ESPECIFICACIONES (UE)

E27, 5W LED Regulable
2700k, (Incluida)
230V, 50/60 Hz
IP20, Clase II
Touch Me Regulable

ETIQUETA ENERGÉTICA

A ++

TECHNICAL

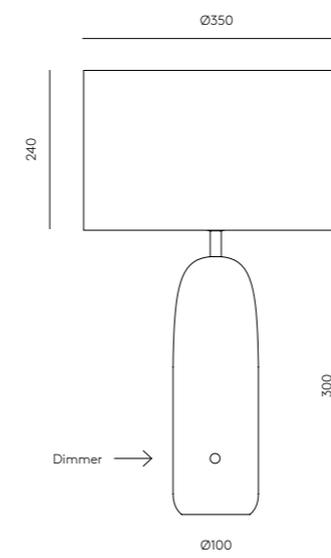

ABBACUS

Table lamp

S1258

Designed by Pepe Fornas, 2018

DESCRIPTION

MATERIALS

Steel / Blown Glass

FINISHES

Metal:
Matt Black
Matt Brass

Glass Shade (Included):
Opal/Clear

SPECIFICATIONS (UE)

Bulb G9, 5W - 2700K
220-240 V, 50/60 Hz
IP20, Class II

ENERGY LABEL

A ++

BULB INCLUDED

B005/5W

IP20 CE   

MATERIALES

Acero / Vidrio Soplado

ACABADOS

Metal:
Negro Mate
Oro Mate

Cristal (Incluido):
Opal/Transparente

ESPECIFICACIONES (UE)

Bombilla G9, 5W - 2700K
220-240 V, 50/60 Hz
IP20, Clase II

ETIQUETA ENERGÉTICA

A ++

BOMBILLA INCLUIDA

B005/5W

TECHNICAL

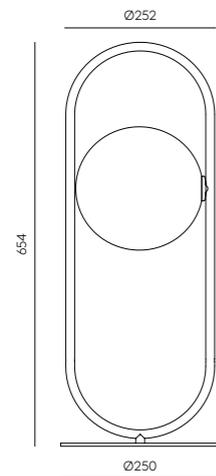

ERTO

Table lamp

S1257

Designed by Pepe Fornas, 2020

DESCRIPTION

MATERIALS

Steel

FINISHES

Metal:
Matt Black
Matt Brass (details)

COMPATIBLE ACCESSORIES
(Included in the price, choose
one from below)

Alabaster - 1096/25
Glass - 1223
Ceramic - 1097/20
Metal - 1038/25
Stripped metal - 1089/25

SPECIFICATIONS (UE)

Bulb G9, 5W - 2700K
220-240 V, 50/60 Hz
IP20, Class II

ENERGY LABEL

A ++

BULB INCLUDED

B005/5W

IP20 CE   

MATERIALES

Acero

ACABADOS

Metal:
Negro mate
Oro mate (detalles)

ACCESORIOS COMPATIBLES
(Incluido en el precio, elige uno
de abajo)

Alabastro - 1096/25
Cristal - 1223
Cerámica - 1097/20
Metal - 1038/25
Metal rayado - 1089/25

ESPECIFICACIONES (UE)

Bombilla G9, 5W - 2700K
220-240 V, 50/60 Hz
IP20, Clase II

ETIQUETA ENERGÉTICA

A ++

BOMBILLA INCLUIDA

B005/5W

TECHNICAL

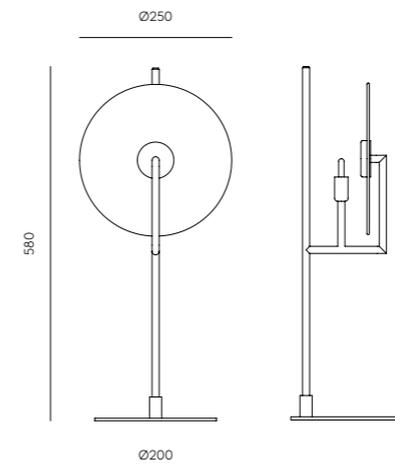

MAHO

S1254

Designed by JF Sevilla, 2020

DESCRIPTION

MATERIALS

Steel

FINISHES

Metal:

Black - Black

Black - Matt Brass

SPECIFICATIONS (UE)

Integrated LED chip 5W 3000K

24V, 50 / 60Hz

IP20, Class II

Touch Me Dimmer on head

ENERGY LABEL

A ++

MATERIALES

Acero

ACABADOS

Metal:

Negro - Negro

Negro - Oro Mate

ESPECIFICACIONES (UE)

Chip LED integrado 5W

3000K, 24V, 50/60Hz

IP20, Clase II

Touch Me Dimmer en cabeza

ETIQUETA ENERGÉTICA

A ++

IP20 CE RoHS WEEE A++

TECHNICAL

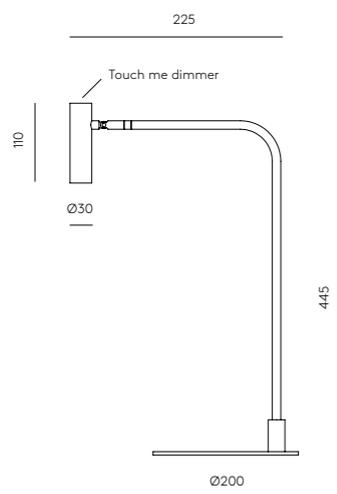

FICUS

Table lamp

S1243

Designed by JF Sevilla, 2017

DESCRIPTION

MATERIALS
Steel

FINISHES

Metal:
Matt Black
Matt Gold (Details)
Shade:
Matt Brass

SPECIFICATIONS (UE)

Bulb G9, 5W - 2700K
220-240 V, 50/60 Hz
IP20, Class II

ENERGY LABEL

A ++

BULB INCLUDED

B005/5W

IP20 CE RoHS A++

MATERIALES
Acero

ACABADOS

Metal:
Negro mate
Oro mate (detalles)
Tulipa:
Oro mate

ESPECIFICACIONES (UE)

Bombilla G9, 5W - 2700K
220-240 V, 50/60 Hz
IP20, Clase II

ETIQUETA ENERGÉTICA

A ++

BOMBILLA INCLUIDA

B005/5W



TECHNICAL

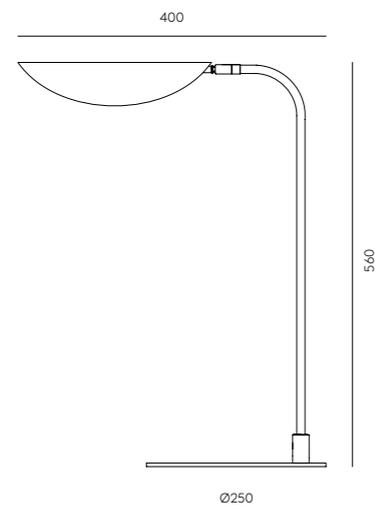

ALOA

Table lamp

S1240 · S1227

Designed by Fornasevi, 2017



DESCRIPTION

MATERIALS
Steel

FINISHES

S1227
Body: Matt black
Base/Shade: Matt black
S1240
Body: Matt brass
Base/Shade: Matt white

POSSIBLE MODIFICATIONS

See color palette

SPECIFICATIONS (UE)

E27 Max. 60W (Not included)
220-240 V, 50/60 Hz
IP20, Class II

ENERGY LABEL

A ++

IMAGE BULB

B038/GOLD (Not included)

IP20 CE RoHS A++

MATERIALES
Acero

ACABADOS

S1227
Cuerpo: Negro mate
Base/Pantalla: Negro mate
S1240
Cuerpo: Oro mate
Base/Pantalla: Blanco mate

MODIFICACIONES POSIBLES

Consultar paleta de colores

ESPECIFICACIONES (UE)

E27 Max. 60W (No incluida)
220-240 V, 50/60 Hz
IP20, Clase II

ETIQUETA ENERGÉTICA

A ++

BOMBILLA IMAGEN

B038/ORO (No incluida)

TECHNICAL

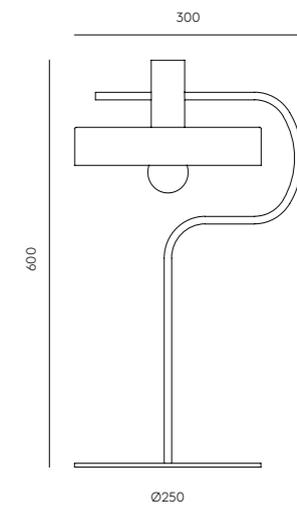

LUCA

Table lamp

S1237

Designed by AC Studio, 2017

DESCRIPTION

MATERIALS

Steel / Marble

FINISHES

Metal:
Matt Black

Marble:
White

SPECIFICATIONS (UE)

E27 Max. 60W (Not included)
220-240 V, 50/60 Hz
IP20, Class II

ENERGY LABEL

A ++

RECOMMENDED BULB

B211 (7, 9, 11W)

IP20 CE    A++

MATERIALES

Acero / Mármol

ACABADOS

Metal:
Negro Mate

Mármol:
Blanco

ESPECIFICACIONES (UE)

E27 Max. 60W (No incluida)
220-240 V, 50/60 Hz
IP20, Clase II

ETIQUETA ENERGÉTICA

A ++

BOMBILLA RECOMENDADA

B211 (7, 9, 11W)

TECHNICAL

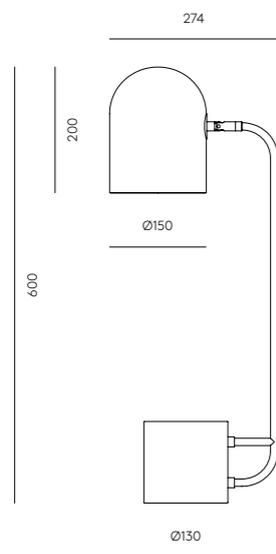

LOLA

Table lamp

S1232

Designed by AC Studio, 2017

DESCRIPTION

MATERIALS

Steel / Concrete

FINISHES

Metal:
Matt Black

Concrete:
Grey

SPECIFICATIONS (UE)

E14 Max. 40W (Not included)
220-240 V, 50/60 Hz
IP20, Class II
Dimmer on concrete base

ENERGY LABEL

A ++

RECOMMENDED BULB

B116-2/REG

IP20 CE    A++

MATERIALES

Acero / Hormigón

ACABADOS

Metal:
Negro Mate

Hormigón:
Gris

ESPECIFICACIONES (UE)

E14 Max. 40W (No incluida)
220-240 V, 50/60 Hz
IP20, Clase II
Regulador en base

ETIQUETA ENERGÉTICA

A ++

BOMBILLA RECOMENDADA

B116-2/REG

TECHNICAL

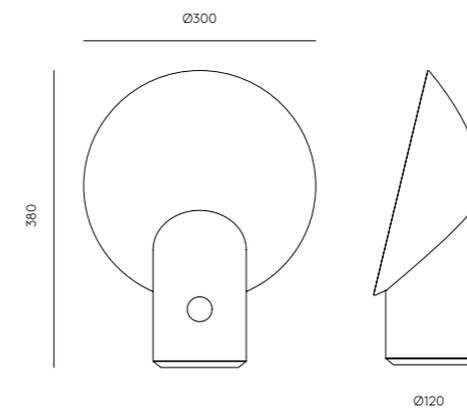

NERA

Table lamp

S1229

Designed by Pepe Fornas, 2020

DESCRIPTION

MATERIALS
Steel / Acrylic

FINISHES
Metal:
Matt black

SPECIFICATIONS (UE)
LED COB integrated 8W
3000K (Included)
12V / 220-240 V, 50/60 Hz
Touch me dimmer on head

ENERGY LABEL
A ++

IP20 CE    

MATERIALES
Acero / Acrílico

ACABADOS
Metal:
Negro Mate

ESPECIFICACIONES (UE)
COB LED integrado 8W
3000K (Incluida)
12V / 220-240 V, 50/60 Hz
Touch me - Regulable en cabezal

ETIQUETA ENERGÉTICA
A ++

TECHNICAL

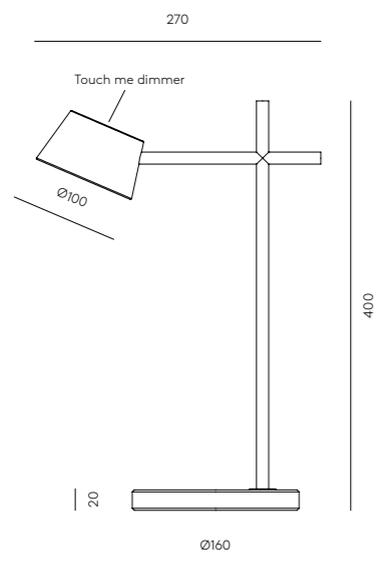

LITA

Table lamp

S1230

Designed by AC Studio, 2020

DESCRIPTION

MATERIALS

Steel / Wood

FINISHES

Metal:
Matt Black

Wood:
Matt Black
Walnut

SPECIFICATIONS (UE)

COB LED integrated 3W 3000K
(Included) Dimmable
Dimmer switch on cable
220-240 V, 50/60 Hz

ENERGY LABEL

A ++



MATERIALES

Acero / Madera nogal

ACABADOS

Metal:
Negro Mate

Madera:
Negro Mate
Nogal

ESPECIFICACIONES (UE)

COB LED integrado 3W
3000K (Incluida) Regulable
Regulador en cable
220-240 V, 50/60 Hz

ETIQUETA ENERGÉTICA

A ++

TECHNICAL

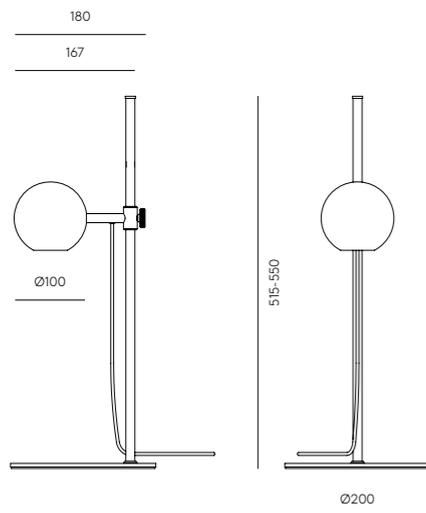

LIND

Table lamp

S1220 - S1220/USB

Designed by Agus Gascón, 2020

DESCRIPTION

MATERIALS

Steel / Alabaster

FINISHES

Metal:
Matt Brass (cable & USB)
Matt Black (USB)

Shade:
Alabastro

SPECIFICATIONS (UE) CABLE

Bulb G9 Led (Included)
5W - 3000K
220-240 V, 50/60 Hz
IP20, Class II

SPECIFICATIONS (UE) PORTABLE

LED COB integrated 3W 3000K
(Included) 4.2 V, 1A, 50/60 Hz
Touch me - Dimmable
Portable and rechargeable
USB charger included

ENERGY LABEL

A ++



MATERIALES

Acero / Alabastro

ACABADOS

Metal:
Negro mate (cable & USB)
Blanco mate (USB)

Tulipa:
Alabastro

ESPECIFICACIONES (UE) CABLE

Bombilla G9 Led (Incluida)
5W - 3000K
220-240 V, 50/60 Hz
IP20, Clase II

ESPECIFICACIONES (UE) PORTÁTIL

COB LED integrado 3W 3000K
(Incluida) 4.2 V, 1A, 50/60 Hz
Touch me - Regulable
Portátil y recargable
Cargador USB incluido

ETIQUETA ENERGÉTICA

A ++

TECHNICAL

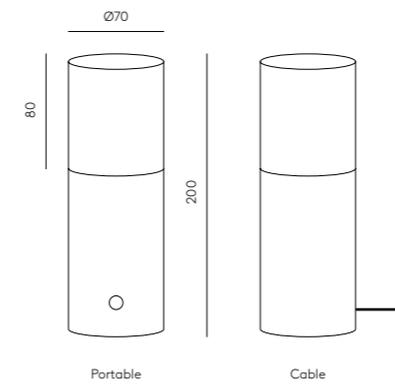

ATOM

Table lamp

S1214

Designed by AC Studio, 2017

DESCRIPTION

MATERIALS

Steel / Blown Glass

FINISHES

Metal:
Matt Black
Matt Brass

Glass Shade (Included):
Opal/Clear

SPECIFICATIONS (UE)

Bulb G9 (Included)
5W - 2700K
220-240 V, 50/60 Hz
IP20, Class II

ENERGY LABEL

A ++

BULB INCLUDED

B005/5W

IP20 CE         

MATERIALES

Acero / Acrílico

ACABADOS

Metal:
Negro Mate
Oro Mate

Cristal (Incluido):
Opal/Transparente

ESPECIFICACIONES (UE)

Bombilla G9 (Incluida)
5W - 2700K
220-240 V, 50/60 Hz
IP20, Clase II

ETIQUETA ENERGÉTICA

A ++

BOMBILLA INCLUIDA

B005/5W

TECHNICAL

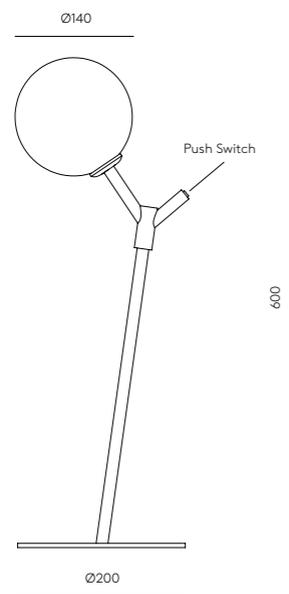

DOBI

Table lamp

S1207

Designed by AC Studio, 2015

DESCRIPTION

MATERIALS

Steel

FINISHES

Metal:
Matt Black

SPECIFICATIONS (UE)

E14 Max. 33W (Not included)
220-240 V, 50/60 Hz
IP20, Class II

ENERGY LABEL

A ++

RECOMMENDED BULB

B116-2 (5W)

IP20 CE         

MATERIALES

Acero

ACABADOS

Metal:
Negro mate

ESPECIFICACIONES (UE)

E14 Max. 33W (No incluida)
220-240 V, 50/60 Hz
IP20, Clase II

ETIQUETA ENERGÉTICA

A ++

BOMBILLA RECOMENDADA

B116-2 (5W)

TECHNICAL

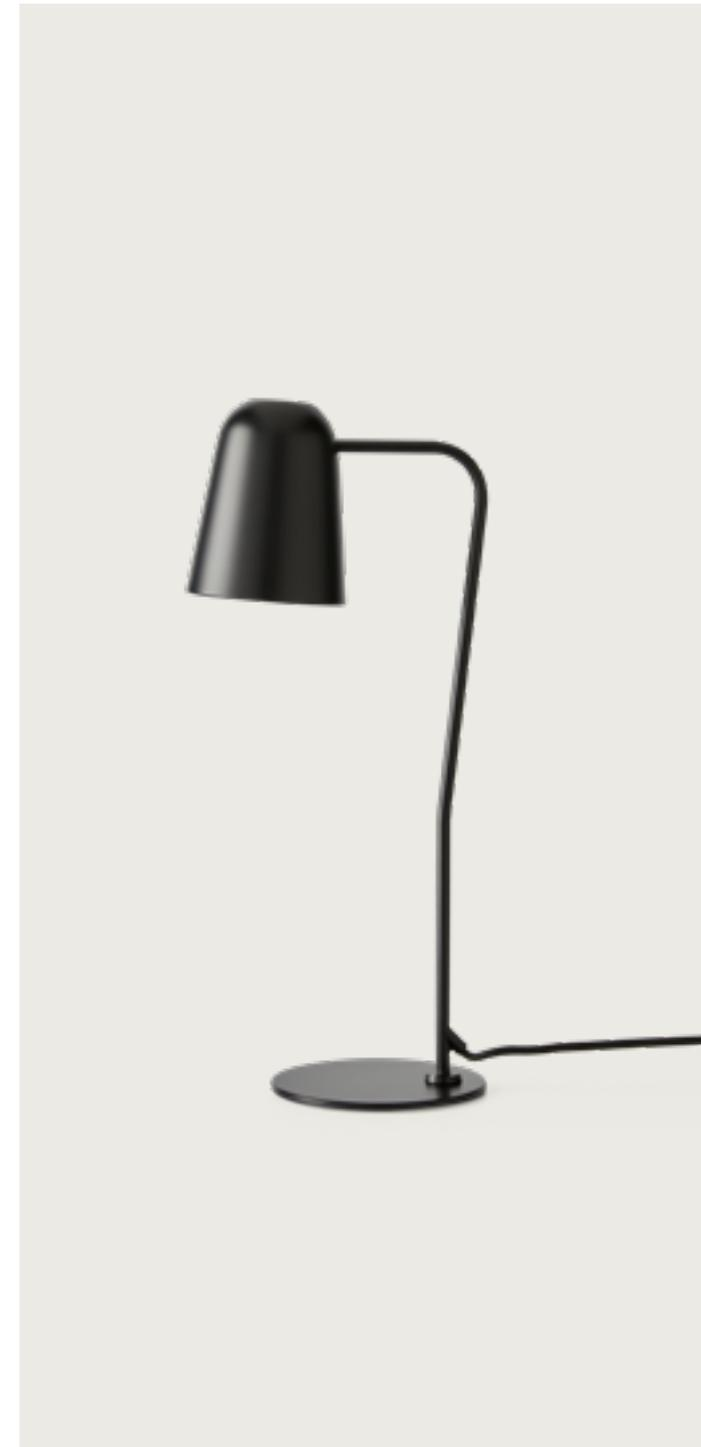
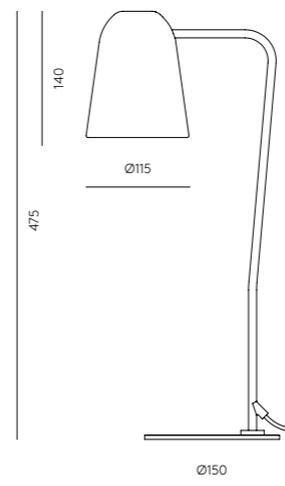

COHEN

Table lamp

S1196

Designed by Jana Chang, 2012

DESCRIPTION

MATERIALS

Steel

FINISHES

Metal: Matt Brass

Shade: Black, Shiny White

SPECIFICATIONS (UE)

E27 Max. 60W (Not included)
220-240 V, 50/60 Hz
IP20, Class II

ENERGY LABEL

A ++

RECOMMENDED BULB

B211 (7, 9, 11W)

MATERIALES

Acero

ACABADOS

Metal: Oro Mate

Tulipa: Negro, Blanco Brillo

ESPECIFICACIONES (UE)

E27 Max. 60W (No incluida)
220-240 V, 50/60 Hz
IP20, Clase II

ETIQUETA ENERGÉTICA

A ++

BOMBILLA RECOMENDADA

B211 (7, 9, 11W)

IP20 CE RoHS A++

TECHNICAL

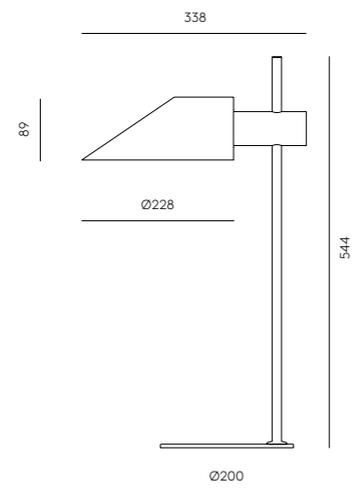

MARU

Table lamp

S1194

Designed by JF Sevilla, 2015

DESCRIPTION

MATERIALS

Steel

FINISHES

Metal: Matt Black - Matt Brass

Matt Black - Matt Black

SPECIFICATIONS (UE)

Integrated Led COB
3W - 3150K
12 V, 50/60 Hz
IP20, Class II

ENERGY LABEL

A ++

IP20 CE RoHS A++

MATERIALES

Acero

ACABADOS

Metal: Negro Mate - Oro Mate

Negro Mate - Negro Mate

ESPECIFICACIONES (UE)

Led COB integrado
3W - 3150K
12 V, 50/60 Hz
IP20, Clase II

ETIQUETA ENERGÉTICA

A ++

TECHNICAL

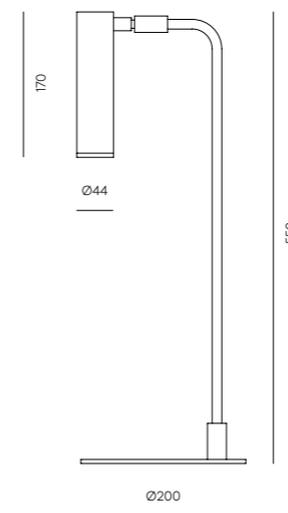

DAMO

S1191

Designed by AC Studio, 2015

DESCRIPTION

MATERIALS

Steel

FINISHES

Metal:
Matt Black

SPECIFICATIONS (UE)

E27 Max. 60W (Not included)
230 V, 50/60 Hz
IP20, Class II

ENERGY LABEL

A ++

RECOMMENDED BULB

B211 (7, 9, 11W)

MATERIALES

Acero

ACABADOS

Metal:
Negro mate

ESPECIFICACIONES (UE)

E27 Max. 60W (No incluida)
230 V, 50/60 Hz
IP20, Clase II

ETIQUETA ENERGÉTICA

A ++

BOMBILLA RECOMENDADA

B211 (7, 9, 11W)

IP20 CE    

TECHNICAL

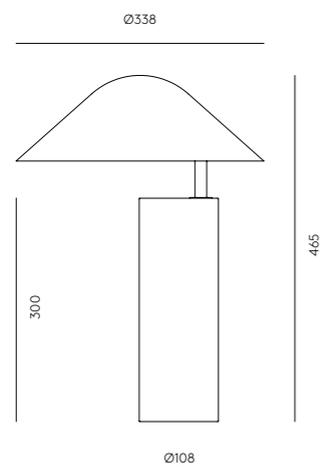

BOA

Table lamp

S1193

Designed by Fornasevi, 2015

DESCRIPTION

MATERIALS

Steel

FINISHES

Body: Matt Black

Shade: Black, Matt Brass

SPECIFICATIONS (UE)

E27 Max. 60W (Not included)
220-240 V, 50/60 Hz
IP20, Class II

ENERGY LABEL

A ++

RECOMMENDED BULB

B211 (7, 9, 11W)

MATERIALES

Acero

ACABADOS

Cuerpo: Negro Mate

Tulipa: Negro, Oro Mate

ESPECIFICACIONES (UE)

E27 Max. 60W (No incluida)
220-240 V, 50/60 Hz
IP20, Clase II

ETIQUETA ENERGÉTICA

A ++

BOMBILLA RECOMENDADA

B211 (7, 9, 11W)

IP20 CE    

TECHNICAL

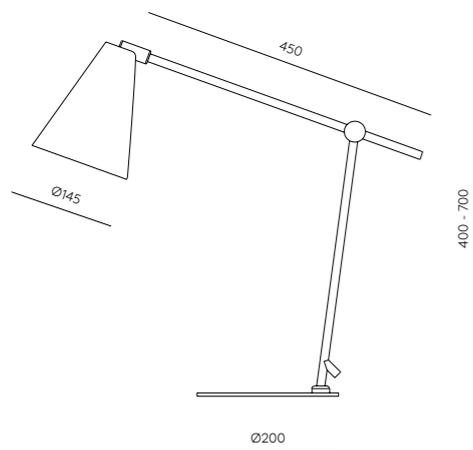

LALU

Table lamp

S1189

Designed by Jana Chang, 2013

DESCRIPTION

MATERIALS

Steel

FINISHES

Metal: Chrome, Shiny brass

Shade: Shiny White

Image color: Green mole

POSSIBLE MODIFICATIONS

Color shade can be changed,
ask us about extracost.
Color palette on page

SPECIFICATIONS (UE)

E27 Max. 60W (Not included)
230 V, 50/60 Hz
IP20, Class II

ENERGY LABEL

A ++

RECOMMENDED BULB

B211 (7,9,11W)

IP20 CE    

MATERIALES

Acero

ACABADOS

Metal: Cromo, Oro Brillo

Tulipa: Blanco brillo

Color en imagen: Verde mole

MODIFICACIONES POSIBLES

Para modificaciones en color de
pantalla consultar sobrecoste.
Paleta de colores en pág.

ESPECIFICACIONES (UE)

E27 Max. 60W (No incluida)
230 V, 50/60 Hz
IP20, Clase II

ETIQUETA ENERGÉTICA

A ++

BOMBILLAS RECOMENDADAS

B211 (7,9,11W)

TECHNICAL

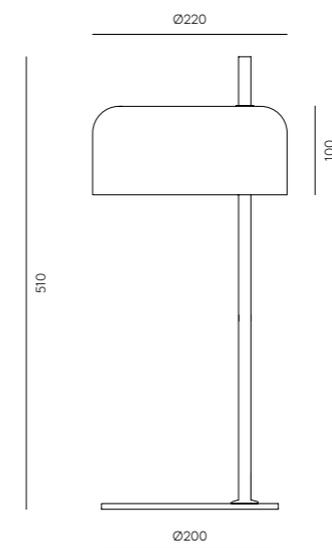

MILA

Table lamp

S1183

Designed by AC Studio, 2014

DESCRIPTION

MATERIALS

Steel / Fabric / Acrylic

FINISHES

Metal: Chrome, Matt Brass

Shade: White, Black

SPECIFICATIONS (UE)

E14 - 2 x Max. 40W

(Not included)

220-240 V, 50/60 Hz

IP20, Class II

ENERGY LABEL

A ++

RECOMMENDED BULB

B116-2 (5W)

MATERIALES

Acero / Pantalla Textil / Acrílico

ACABADOS

Metal: Cromo, Oro Mate

Pantalla: Blanco, Negro

ESPECIFICACIONES (UE)

E14 - 2 x Max. 40W

(No incluida)

220-240 V, 50/60 Hz

IP20, Clase II

ETIQUETA ENERGÉTICA

A ++

BOMBILLA RECOMENDADA

B116-2 (5W)

IP20 CE

TECHNICAL

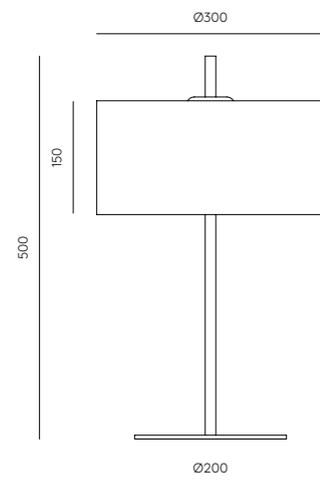

HEDRA

Table lamp

S1159

Designed by AC Studio, 2021

DESCRIPTION

MATERIALS

Steel / Marble

FINISHES

Metal: Matt Black, Matt Brass

Marble: Matt black

Recommended shade:

801011/31 (Not included)

OTHER OPTIONS

Dome 1159 - 35cm Diameter

SPECIFICATIONS (UE)

E27LED regulable 9W 3000K
(included), 220-240 V, 50/60 Hz
IP20, Class II

ENERGY LABEL

A ++



MATERIALES

Acero/ Mármol

ACABADOS

Metal: Negro mate ,Oro mate

Mármol: Negro mate

Pantalla recomendada:

801011/31 (No incluida)

OTRAS OPCIONES:

Cupula 1159 - 35cm Diámetro

ESPECIFICACIONES (UE)

E27LED regulable 9W 3000K
(incluida) 230V, 50/60 Hz
IP20, Clase II

ETIQUETA ENERGÉTICA

A ++

TECHNICAL

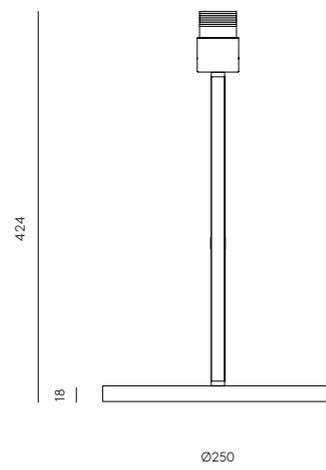

STAN

Table lamp

S1154

Designed by Fornasevi, 2018

DESCRIPTION

MATERIALS

Steel / Rattan

FINISHES

Metal:

Matt Brass

Matt Black

Rattan:

Natural

Black

SPECIFICATIONS (UE)

E27 Max. 60W (Not included)
220-240 V, 50/60 Hz
IP20, Class II

ENERGY LABEL

A ++

RECOMMENDED BULB

B033/COB



MATERIALES

Acero/ Ratán

ACABADOS

Metal:

Oro Mate

Negro Mate

Ratán:

Natural

Negro

ESPECIFICACIONES (UE)

E27 Max. 60W (No incluida)
220-240 V, 50/60 Hz
IP20, Clase II

ETIQUETA ENERGÉTICA

A ++

BOMBILLA RECOMENDADA

B033/COB

TECHNICAL

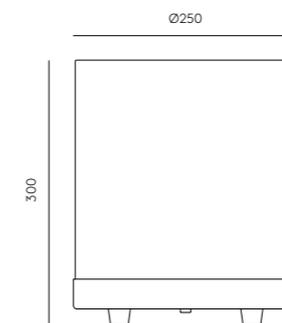

ENDO

Table lamp

S1156

Designed by Pepe Fornas, 2013

DESCRIPTION

MATERIALS

Steel / Blown Glass

FINISHES

Metal: Matt Brass, Chrome

Shade (Included): Opal

SPECIFICATIONS (UE)

Bulb G9 Led - 5W (Included)
2700K

220-240 V, 50/60 Hz
IP20, Class II

ENERGY LABEL

A ++

RECOMMENDED BULB

B005/5W

MATERIALES

Acero/ Vidrio Soplado

ACABADOS

Metal: Oro Mate, Cromo

Tulipa (Incluida): Opal

ESPECIFICACIONES (UE)

Bombilla G9 Led - 5W (Incluida)
2700K

220-240 V, 50/60 Hz
IP20, Clase II

ETIQUETA ENERGÉTICA

A ++

BOMBILLA RECOMENDADA

B005/5W

IP20 CE RoHS WEEE A++

TECHNICAL

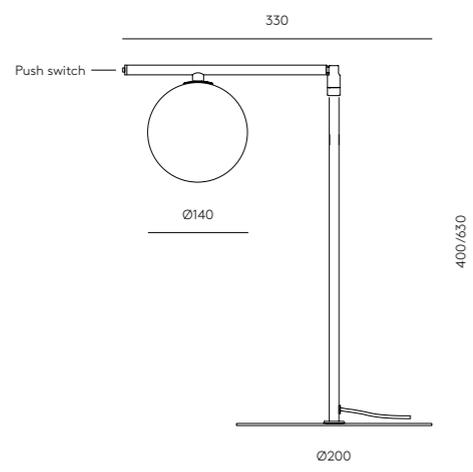

Zagreb, Croatia



HEDULA

Table lamp

S1150

Designed by AC Studio, 2020

DESCRIPTION

MATERIALS

Wood / Natural Fiber

FINISHES

Wood:
Black
Natural

Fiber:
Black

SPECIFICATIONS (UE)

E27 max. 60W (Not included)
220-240 V, 50/60 Hz
IP20, Class II

ENERGY LABEL

A ++

MATERIALES

Madera / Médula

ACABADOS

Madera:
Negro
Natural

Médula:
Negro

ESPECIFICACIONES (UE)

E27 max. 60W (No incluida)
220-240 V, 50/60 Hz
IP20, Clase II

ETIQUETA ENERGÉTICA

A ++

IP20 CE    

TECHNICAL

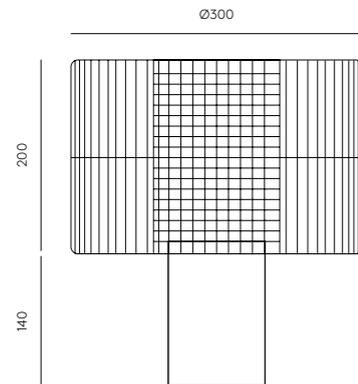

SAND

Table lamp

S1109

Designed by AC Studio, 2019

DESCRIPTION

MATERIALS

Terrazzo

FINISHES

Terrazzo: Grey

Shade included

SPECIFICATIONS (UE)

E27, 9W, 2700K
Dimmable (included)
Dimmer switch on base
220-240 V, 50/60 Hz
IP20, Class II

ENERGY LABEL

A ++

RECOMMENDED BULB

B211- 7/9/11W - Dimmable

MATERIALES

Terrazzo

ACABADOS

Terrazzo: Gris

Pantalla incluida

ESPECIFICACIONES (UE)

E27, 9W, 2700K
Regulable(incluida)
Regulador en la base
220-240 V, 50/60 Hz
IP20, Clase II

ETIQUETA ENERGÉTICA

A ++

BOMBILLA RECOMENDADA

B211- 7/9/11W - Regulable

IP20 CE    

TECHNICAL

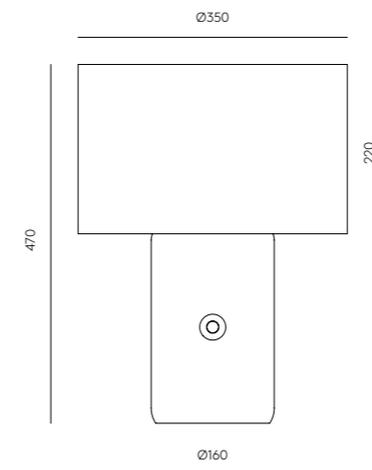

Tunis, Tunisia



ALDA

Table lamp

S1108

Designed by AC Studio, 2020

DESCRIPTION

MATERIALS

Steel / Wood / Marble

FINISHES

Metal: Matt black, Matt white
Matt brass, Shiny gold, Chrome

Wood: Black, Natural, Colour

Marble: Black, White,
Green, Brown

Image Shade:
801021/36 Not included

SPECIFICATIONS (UE)

E27 max. 60W (Not included)
220-240 V, 50/60 Hz
IP20, Class II

ENERGY LABEL

A++

ASK FOR CUSTOMIZED
POSSIBILITIES



MATERIALES

Acero / Madera / Mármol

ACABADOS

Metal: Negro Mate, Blanco Mate
Oro Mate, Oro Brillo, Cromo

Madera: Natural, Negro, Color

Mármol: Negro, Blanco,
Verde, Marrón.

Pantalla de imagen:
801021/36 No incluida.

ESPECIFICACIONES (UE)

E27 max. 60W (No incluida)
220-240 V, 50/60 Hz
IP20, Clase II

ETIQUETA ENERGÉTICA

A++

CONSULTAR POSIBILIDADES
DE CUSTOMIZACIÓN

TECHNICAL

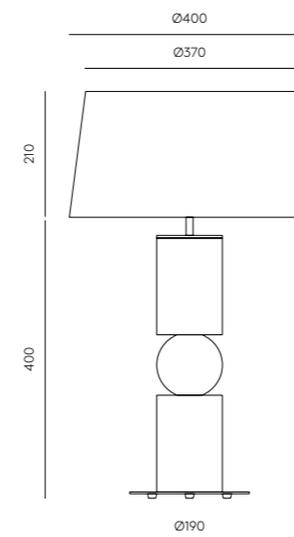

CAND

S1107

Designed by AC Studio, 2018

DESCRIPTION

MATERIALS

Steel / Marble

FINISHES

Metal:
Aged Gold
Marble:
Black

POSSIBLE MODIFICATIONS

Image reference shade
801021/35. Shade not included.

SPECIFICATIONS (UE)

E27 Max. 60W (Not included)
220-240 V, 50/60 Hz, IP20,
Class II

ENERGY LABEL

A ++

RECOMMENDED BULB

B211 (7, 9, 11W)

MATERIALES

Acero / Mármol

ACABADOS

Metal:
Oro Envejecido
Mármol:
Negro

MODIFICACIONES POSIBLES

Pantalla imagen 801021/35
Pantalla no incluida.

ESPECIFICACIONES (UE)

E27 Max. 60W (No incluida)
220-240 V, 50/60 Hz, IP20,
Clase II

ETIQUETA ENERGÉTICA

A ++

BOMBILLA RECOMENDADA

B211 (7, 9, 11W)

IP20 CE   

TECHNICAL

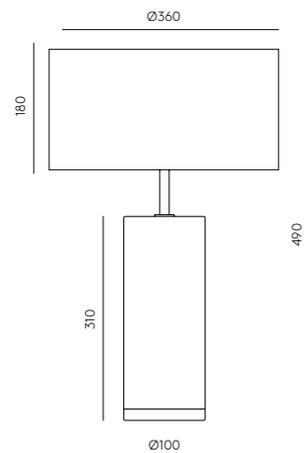

ONA

Table lamp

S1029

Designed by JI Ballester, 2008

DESCRIPTION

MATERIALS

Steel / Fabric / Acrylic

FINISHES

Metal: Nickel

Shade (included): White / Black

SPECIFICATIONS (UE)

E14 - 2 x Max. 40W

(Not included)

220-240 V, 50/60 Hz

IP20, Class II

ENERGY LABEL

A ++

RECOMMENDED BULB

B116-2 (5W)



MATERIALES

Acero / Pantalla Textil / Acrílico

ACABADOS

Metal: Niquel

Pantalla (incluida): Blanco / Negro

ESPECIFICACIONES (UE)

E14 - 2 x Max. 40W (No incluida)

220-240 V, 50/60 Hz

IP20, Clase II

ETIQUETA ENERGÉTICA

A ++

BOMBILLA RECOMENDADA

B116-2 (5W)

TECHNICAL

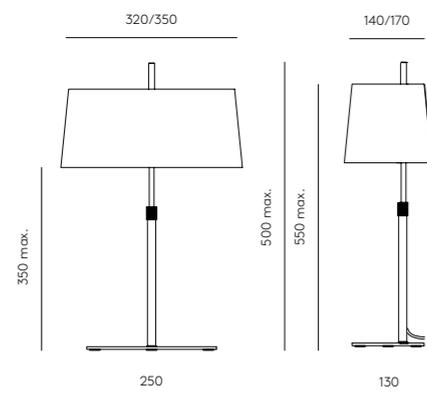

TEX

Table lamp

S1026

Designed by AC Studio, 2012

DESCRIPTION

MATERIALS

Steel

FINISHES

Metal: Matt White

Matt Black

Image shade:

801021/36

SPECIFICATIONS (UE)

E27 Max. 60W (Not included)

220-240 V, 50/60 Hz

IP20, Class II

ENERGY LABEL

A ++

RECOMMENDED BULB

B211 (7, 9, 11W)



MATERIALES

Acero

ACABADOS

Metal: Blanco Mate

Negro Mate

Pantalla de la imagen:

801021/36

ESPECIFICACIONES (UE)

E27 Max. 60W (No incluida)

220-240 V, 50/60 Hz

IP20, Clase II

ETIQUETA ENERGÉTICA

A ++

BOMBILLA RECOMENDADA

B211 (7, 9, 11W)

TECHNICAL

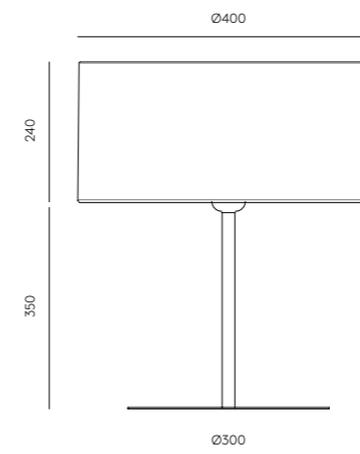

ONUT

NAC130

Designed by AC Studio, 2023

DESCRIPTION

Materials
Metal / Ceramic

MATERIALES
Metal / Cerámica

FINISHES
Metal:
Matt black/ White
matt /Matt gold or glossy /Chrome
Ceramic (Hand-painted):
Consult color palette
Image colour:
Terracotta

ACABADOS
Metal:
Negro mate/ Blanco
mate /Oro mate o brillo /Cromo
Cerámica (Pintada a mano):
Consultar paleta de colores
Color de la imagen:
Terracotta

PICTURE SCREEN 801011/41
Not included

PANTALLA IMAGEN 801011/41
No incluida

SPECIFICATIONS (EU)
E27 Max. 60W LED (not included)
220-240V, 50/60Hz,
IP20, Class II

ESPECIFICACIONES (UE)
E27 Max. 60W LED (no incluida)
220-240 V, 50/60 Hz,
IP20, Clase II

DIMMER POSSIBILITY
B057 12W (Dimmable) + Dimmer
(extra cost to consult)

POSIBILIDAD REGULACIÓN
B057 12W (Regulable) + Regula-
dor (sobrecoste a consultar)

ENERGY LABEL
A++

ETIQUETA ENERGÉTICA
A ++

IP20 CE    

TECHNICAL

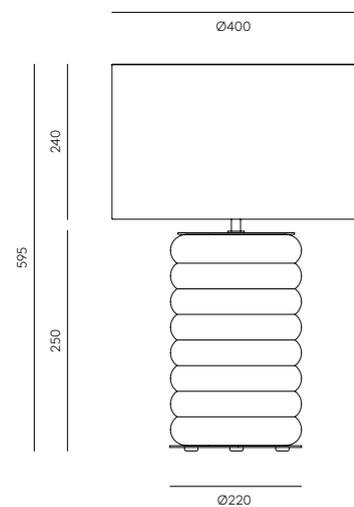

Luxembourg



Dublin, Ireland

BORA

Table lamp

NAC129

Designed by AC Studio, 2022

DESCRIPTION

MATERIALS

Glass/ Steel or ceramics /
Synthetic leather

FINISHES

Steel:
Matt black
Aged gold

Ceramics:
See colour palette

Glass:
Curly transparent

Synthetic leather:
Brown

Image colours:
Left ceramic green leaf
Right metal matt black

SPECIFICATIONS

Led plate 3W 3000K (included)
5V/2A Battery 4800mAh
50/60 Hz IP65 - Class III
Touch me - Dimmable
Portable and rechargeable
Charger and cable included

ENERGY LABEL

A ++



MATERIALES

Vidrio / Metal o Cerámica /
Cuero Sintético

ACABADOS

Metal:
Negro Mate
Oro envejecido

Cerámica:
Consultar paleta de colores

Vidrio:
Transparente rizado

Cuero Sintético:
Marrón

Colores en imagen:
Izda. cerámica verde hoja
Dcha. metal negro mate

ESPECIFICACIONES

Placa Led 3W 3000K (incluida)
5V/2A Bateria 4800mAh
50/60 Hz IP65 - Clase III
Touch me - Regulable
Portátil y recargable
Cargador y cable incluido

ETIQUETA ENERGÉTICA

A ++

TECHNICAL

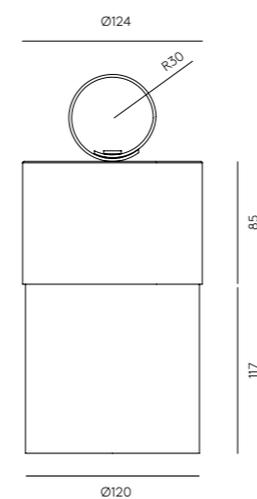

TILLA

Table lamp

NAC128

Designed by Agus Gascón, 2022

DESCRIPTION

MATERIALS

Steel / Glass

FINISHES

Steel:
Matt black
Matt white
Matt Brass
Bright gold
Chrome

Glass:

See colour palette

Image colours:

Left Silhouette
Right Petrol blue

SPECIFICATIONS

E27 max. 60W Max.
(Not included)
220-240V, 50/60Hz
IP20, Class II
Shade (Not included)
Dimmer option

ENERGY LABEL

A ++

IP20 CE RoHS A++

MATERIALES

Acero / Vidrio

ACABADOS

Metal:
Negro Mate
Blanco Mate
Latón Mate
Oro Brillo
Cromo

Vidrio:

Ver paleta de colores

Colores en imagen:

Izquierda Silhouette
Derecha Azul sombrío

ESPECIFICACIONES

E27 max. 60W Max.
(No incluida)
220-240V, 50/60 Hz
IP20, Clase II
PANTALLA(No incluida)
Posibilidad regulación

ETIQUETA ENERGÉTICA

A ++

TECHNICAL

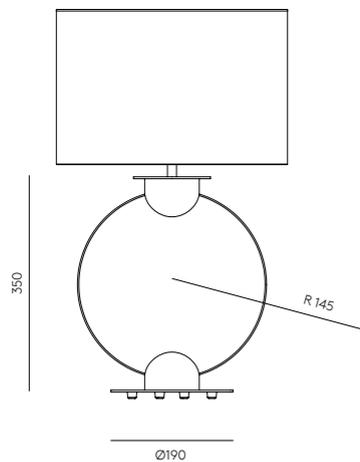

Bogotá, Colombia



Auckland, New Zealand



DAB

Table lamp

NAC127

Designed by AC Studio, 2022

DESCRIPTION

MATERIALS

Steel / Ceramics

FINISHES

Steel:
Matt Brass
Matt black
Matt White

Ceramics hand painted:
See colour palette

Image colours:

Left Green mole
Right Terracotta

SPECIFICATIONS

E27 max. 60W Max.
(Not included)
220-240V, 50/60 Hz
IP20, Class II
Shade (Not included)
Dimmable option

ENERGY LABEL

A ++



MATERIALES

Acero / Cerámica

ACABADOS

Metal:
Oro mate
Negro mate
Blanco mate

Cerámica pintada a mano:
Consulta Paleta de colores

Colores en imagen:

Izda. Verde Mole
Dcha. Terracotta

ESPECIFICACIONES

E27 max. 60W Max.
(No incluida)
220-240V, 50/60 Hz
IP20, Clase II
Pantalla (No incluida)
Posibilidad regulación

ETIQUETA ENERGÉTICA

A ++

TECHNICAL

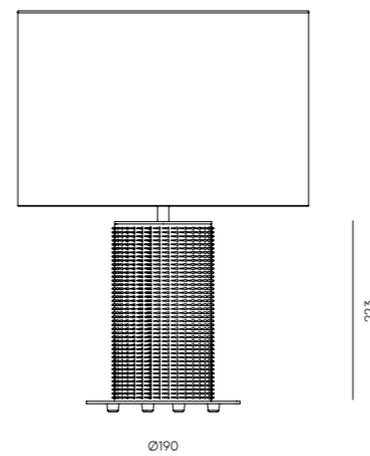

BABEL

Table lamp

NAC126

Designed by AC Studio, 2022

DESCRIPTION

MATERIALS

Steel / Ceramic

FINISHES

Metal: Matt black / Matt white
Matt Brass / Shiny Gold / Chrome

Ceramics (Hand Painted):
See colour palette.

Image color: Silhouette.

IMAGE SHADE 801011/41

Not included

SPECIFICATIONS (UE)

E27 max. 60W Max.(not included)
230V, 50/60 Hz, IP20, Class II

DIMMABLE OPTION

B211 11W (Dimmable) + Dimmer
(ask for extra cost)

ENERGY LABEL

A ++



MATERIALES

Acero / Cerámica

ACABADOS

Metal: Negro mate / Blanco
mate /Oro mate o brillo / Cromo

Cerámica (Pintada a mano):
Consultar paleta de colores

Color de la imagen: Silhouette.

PANTALLA IMAGEN 801011/41

No incluida

ESPECIFICACIONES (UE)

E27 max. 60W Max. (no incluida)
230V, 50/60 Hz, IP20, Clase II

POSIBILIDAD REGULACIÓN

B211 11W (Regulable) + Regulador
(sobrecoste a consultar)

ETIQUETA ENERGÉTICA

A ++

TECHNICAL

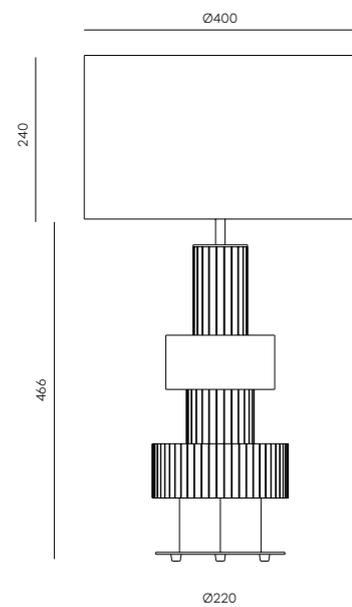

GOT

Table lamp

NAC125

Designed by AC Studio, 2022

DESCRIPTION

MATERIALS

Steel / Ceramic

FINISHES

Metal: Matt black / Matt white
Matt Brass / Shiny Gold / Chrome

Ceramics (Hand Painted):
See colour palette.

Image color: Pale Pink.

IMAGE SHADE 11532

Not included

SPECIFICATIONS (UE)

E27 max. 60W Max.(not included)
230V, 50/60 Hz, IP20, Class II

DIMMABLE OPTION

B211 11W (Dimmable) + Dimmer
(ask for extra cost)

ENERGY LABEL

A ++



MATERIALES

Acero / Cerámica

ACABADOS

Metal: Negro mate / Blanco
mate /Oro mate o brillo / Cromo

Cerámica (Pintada a mano):
Consultar paleta de colores

Color de la imagen: Rosa Palo.

PANTALLA IMAGEN 11532

No incluida

ESPECIFICACIONES (UE)

E27 max. 60W Max. (no incluida)
230V, 50/60 Hz, IP20, Clase II

POSIBILIDAD REGULACIÓN

B211 11W (Regulable) + Regulador
(sobrecoste a consultar)

ETIQUETA ENERGÉTICA

A ++

TECHNICAL

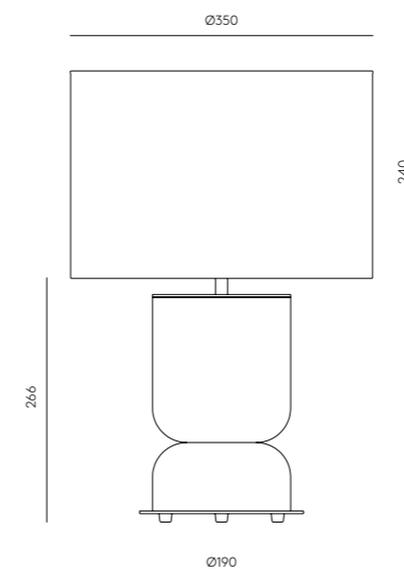

COPO

Table lamp

NAC124

Designed by Pepe Fornas, 2021

DESCRIPTION

MATERIALS

Steel / Ceramic

FINISHES

Metal: Matt black / Matt white
Matt Brass / Shiny Gold / Chrome

Ceramics (Hand Painted):
See colour palette.

Image color: Up mexico blue /
Down green leaf

IMAGE SHADE 801011/46

Not included

SPECIFICATIONS (UE)

E27 max. 11W LED (not included)
230V, 50/60 Hz
IP20, Class II

DIMMABLE OPTION

B211 11W (Dimmable) + Dimmer
(ask for extra cost)

ENERGY LABEL

A ++

IP20 CE    

MATERIALES

Acero / Cerámica

ACABADOS

Metal: Negro mate/ Blanco
mate /Oro mate o brillo/ Cromo

Cerámica (Pintada a mano):
Consultar paleta de colores

Color de la imagen: arriba: azul
mexico / abajo: verde hoja

PANTALLA IMAGEN 801011/46

No incluida

ESPECIFICACIONES (UE)

E27 max. 11W LED (no incluida)
230V, 50/60 Hz
IP20, Clase II

POSIBILIDAD REGULACIÓN

B211 11W (Regulable) + Regulador
(sobrecoste a consultar)

ETIQUETA ENERGÉTICA

A ++

TECHNICAL

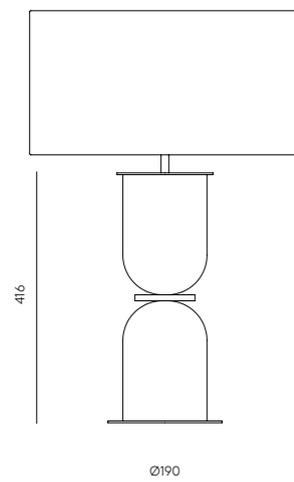

AGRA

Table lamp

NAC123

Designed by Pepe Fornas, 2021

DESCRIPTION

MATERIALS

Steel / Ceramic

FINISHES

Metal: Matt black / Matt white
Matt Brass / Shiny Gold / Chrome

Ceramics (Hand painted):
See colour palette

Image color:
Silhouette

IMAGE SHADE 801011/41

Not included

SPECIFICATIONS (UE)

E27 max. 11W LED (not incl)
230V, 50/60 Hz
IP20, Class II

DIMMABLE OPTION

B211 11W (Dimmable) + Dimmer
(ask for extra cost)

ENERGY LABEL

A ++

IP20 CE    

MATERIALES

Acero / Cerámica

ACABADOS

Metal: Negro mate / Blanco
mate /Oro mate o brillo / Cromo

Cerámica (Pintada a mano):
Consultar paleta de colores

Color de la imagen:
Silhouette

PANTALLA IMAGEN 801011/41

No incluida

ESPECIFICACIONES (UE)

E27 max. 11W LED (no incluida)
230V, 50/60 Hz
IP20, Clase II

POSIBILIDAD REGULACIÓN

B211 11W (Regulable) + Regulador
(sobrecoste a consultar)

ETIQUETA ENERGÉTICA

A ++

TECHNICAL

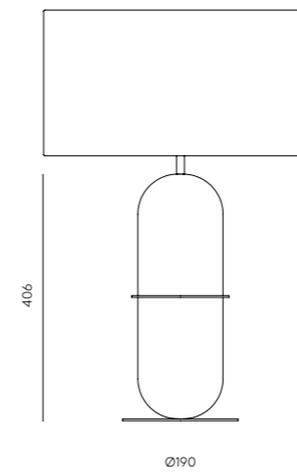

ENA

Table lamp

NAC121

Designed by AC Studio, 2020

DESCRIPTION

MATERIALS

Steel / Ceramic

FINISHES

Metal: Matt black / Matt white
Matt Brass / Shiny Gold / Chrome

Ceramics (Hand Painted):
See colour palette.

Image colours:

Left Banana green
Right Silhouette

IMAGE SHADE 801011/41

Not included

SPECIFICATIONS (UE)

E27 max. 60W (not included)
220-240 V, 50/60 Hz,
IP20, Class II

DIMMABLE OPTION

B211 11W (Dimmable) + Dimmer
(ask for extra cost)

ENERGY LABEL

A ++

IP20 CE 

MATERIALES

Acero / Cerámica

ACABADOS

Metal: Negro mate/ Blanco
mate / Oro mate o brillo/ Cromo

Cerámica (Pintada a mano):
Consultar paleta de colores

Color en imagen:

Izda. Banana green
Dcha. Silhouette

PANTALLA IMAGEN 801011/41

No incluida

ESPECIFICACIONES (UE)

E27 max. 60W (no incluida)
220-240 V, 50/60 Hz,
IP20, Clase II

POSIBILIDAD REGULACIÓN

B211 11W (Regulable) + Regulador
(sobrecoste a consultar)

ETIQUETA ENERGÉTICA

A ++

TECHNICAL

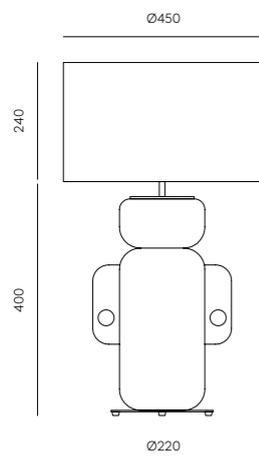

Lima, Peru



ADON

Table lamp

NAC119

Designed by AC Studio, 2020

DESCRIPTION

MATERIALS

Steel / Ceramic

FINISHES

Metal: Matt black / Matt white
Matt Brass / Shiny Gold / Chrome

Ceramics (Hand Painted):
See colour palette.

Image color: Terracotta

IMAGE SHADE 801021/41

Not included

SPECIFICATIONS (UE)

E27 Max. 60W (not included)
220-240 V, 50/60 Hz
IP20, Class II

DIMMABLE OPTION

B211 11W (Dimmable) + Dimmer
(ask for extra cost)

ENERGY LABEL

A ++

IP20 CE RoHS A++

MATERIALES

Acero / Cerámica

ACABADOS

Metal: Negro mate/ Blanco
mate / Oro mate o brillo/ Cromo

Cerámica (Pintada a mano):
Consultar paleta de colores

Color de la imagen: Terracotta

PANTALLA IMAGEN 801021/41

No incluida

ESPECIFICACIONES (UE)

E27 max. 60W (No incluida)
220-240 V, 50/60 Hz
IP20, Clase II

POSIBILIDAD REGULACIÓN

B211 11W (Regulable) + Regulador
(sobrecoste a consultar)

ETIQUETA ENERGÉTICA

A ++

TECHNICAL

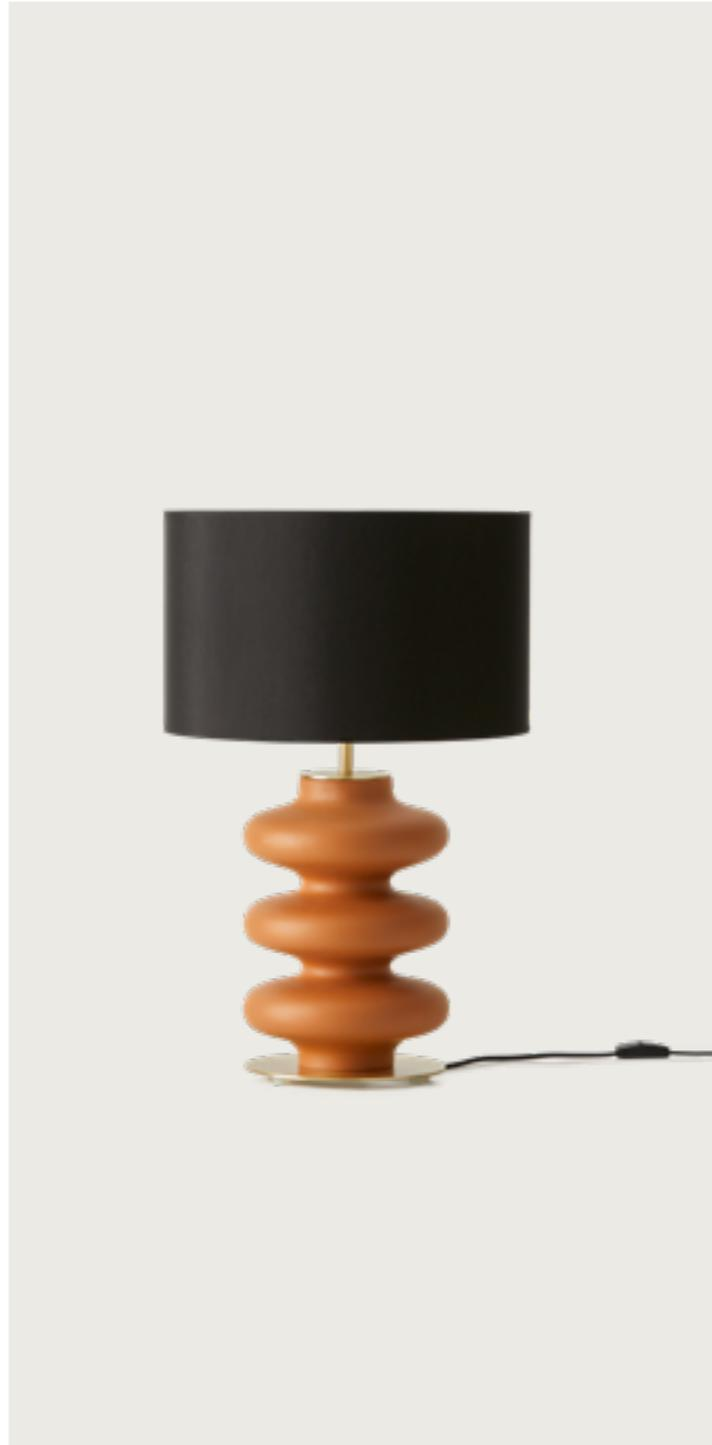
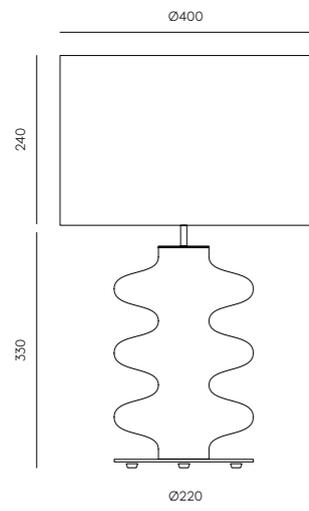

HOME

Table lamp

NAC118

Designed by Pepe Fornas, 2021

DESCRIPTION

MATERIALS

Steel / Ceramic

FINISHES

Metal: Matt black / Matt white
Matt Brass / Shiny Gold / Chrome

Ceramics (Hand Painted):
See colour palette.

Image color: Ash Grey

IMAGE SHADE 801011/40

Not included

SPECIFICATIONS (UE)

E27 Max. 60W LED (not included)
220-240 V, 50/60 Hz,
IP20, Class II

DIMMABLE OPTION

B211 11W (Dimmable) + Dimmer
(ask for extra cost)

ENERGY LABEL

A ++

IP20 CE RoHS A++

MATERIALES

Acero / Cerámica

ACABADOS

Metal: Negro mate/ Blanco
mate / Oro mate o brillo/ Cromo

Cerámica (Pintada a mano):
Consultar paleta de colores

Color de la imagen: Gris Ceniza

PANTALLA IMAGEN 801011/40

No incluida

ESPECIFICACIONES (UE)

E27 Max. 60W LED (no incluida)
220-240 V, 50/60 Hz,
IP20, Clase II

POSIBILIDAD REGULACIÓN

B211 11W (Regulable) + Regulador
(sobrecoste a consultar)

ETIQUETA ENERGÉTICA

A ++

TECHNICAL

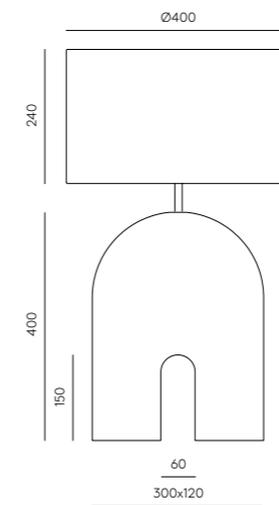

METRIC

Table lamp

NAC117

Designed by Pepe Fornas, 2019

DESCRIPTION

MATERIALS

Steel / Ceramic

FINISHES

Metal: Matt black / Matt white
Matt Brass / Shiny Gold / Chrome

Ceramics (Hand Painted):
See colour palette.

Image color: Silhouette

IMAGE SHADE 801011/41

Not included

SPECIFICATIONS (UE)

E27 Max. 60W LED (not included)
220-240 V, 50/60 Hz,
IP20, Class II

DIMMABLE OPTION

B211 11W (Dimmable) + Dimmer
(ask for extra cost)

ENERGY LABEL

A ++



MATERIALES

Acero / Cerámica

ACABADOS

Metal: Negro mate/ Blanco mate /Oro mate o brillo /Cromo

Cerámica (Pintada a mano):
Consultar paleta de colores

Color de la imagen: Silhouette

PANTALLA IMAGEN 801011/41

No incluida

ESPECIFICACIONES (UE)

E27 Max. 60W LED (no incluida)
220-240 V, 50/60 Hz,
IP20, Clase II

POSIBILIDAD REGULACIÓN

B211 11W (Regulable) + Regulador
(sobrecoste a consultar)

ETIQUETA ENERGÉTICA

A ++

TECHNICAL

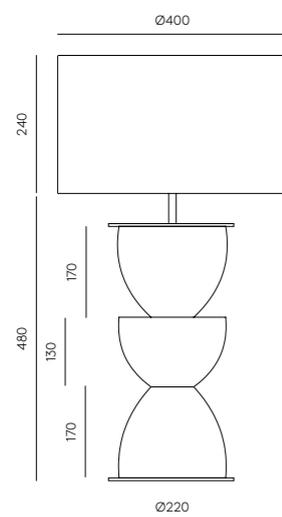

SONICA

Table lamp

NAC116 · NAC114

Designed by AC Studio, 2019

DESCRIPTION

MATERIALS

Steel / Ceramic

FINISHES

Metal: Matt black / Matt white
Matt Brass / Shiny Gold / Chrome

Ceramics (Hand Painted):
See colour palette.

Image colors:

Silhouette / Vintage brown
Next page Taupe / Green leaf

IMAGE SHADE (Not Included)

NAC116 801021/36,
NAC114 801011/35

SPECIFICATIONS (UE)

E27 Max. 60W LED (not included)
220-240 V, 50/60 Hz,
IP20, Class II

ENERGY LABEL

A ++



MATERIALES

Acero / Cerámica

ACABADOS

Metal: Negro mate/ Blanco mate / Oro mate o brillo / Cromo

Cerámica (Pintada a mano):
Consultar paleta de colores

Color de la imagen:

Silhouette / Marrón vintage
Siguiente pág. Topo / Verde hoja

PANTALLA IMAGEN (No incluida)

NAC116 801021/36,
NAC114 801011/35

ESPECIFICACIONES (UE)

E27 Max. 60W LED (no incluida)
220-240 V, 50/60 Hz,
IP20, Clase II

ETIQUETA ENERGÉTICA

A ++

TECHNICAL

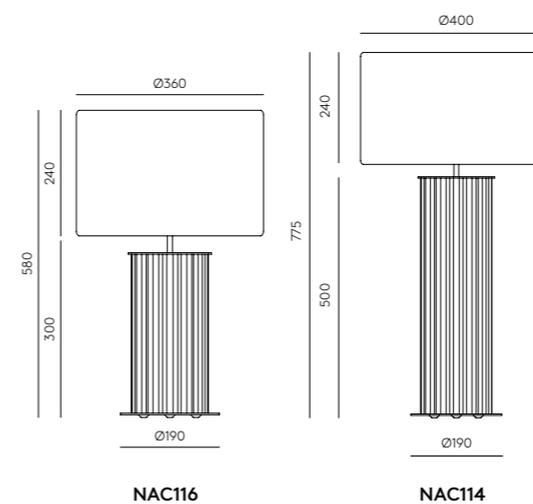



ATINA

Table lamp

NAC115

Designed by AC Studio, 2019

DESCRIPTION

MATERIALS

Steel / Glass

FINISHES

Metal: Matt black / Matt white
Matt Brass / Shiny Gold / Chrome

Glass (Hand Painted):

See colour palette.

Image color: Mexico Blue

IMAGE SHADE 801011/41

Not included

SPECIFICATIONS (UE)

E27 Max. 60W (Not included)
220-240 V, 50/60 Hz, IP20, Class II

ENERGY LABEL

A ++



MATERIALES

Acero / Vidrio

ACABADOS

Metal: Negro mate/ Blanco mate/
Oro mate o brillo/ Cromo

Vidrio (Pintado a mano):

Consultar paleta de colores

Color de la imagen: Azul México

PANTALLA IMAGEN 801011/41

No incluida

ESPECIFICACIONES (UE)

E27 Max. 60W (no incluida)
220-240 V, 50/60 Hz, IP20, Clase II

ETIQUETA ENERGÉTICA

A ++

TECHNICAL

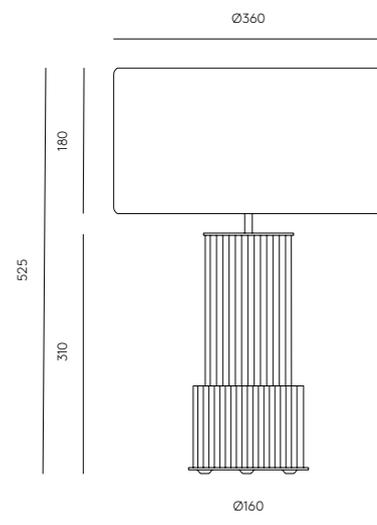

TARO

Table lamp

NAC113

Designed by AC Studio, 2019

DESCRIPTION

MATERIALS

Steel / Ceramic

FINISHES

Metal: Matt black / Matt white
Matt Brass / Shiny Gold / Chrome

Ceramics (Hand Painted):

See colour palette.

Image color:

Green Leaf

IMAGE SHADE(Not Included)

801021/41

SPECIFICATIONS (UE)

E27 Max. 60W LED (not included)
220-240 V, 50/60 Hz, IP20, Class II

ENERGY LABEL

A ++



MATERIALES

Acero / Cerámica

ACABADOS

Metal: Negro mate/ Blanco mate/
Oro mate o brillo/ Cromo

Cerámica (Pintada a mano):

Consultar paleta de colores

Color de la imagen:

Verde hoja

PANTALLA IMAGEN (No incluida)

801011/41

ESPECIFICACIONES (UE)

E27 Max. 60W LED (no incluida)
220-240 V, 50/60 Hz, IP20, Clase II

ETIQUETA ENERGÉTICA

A ++

TECHNICAL

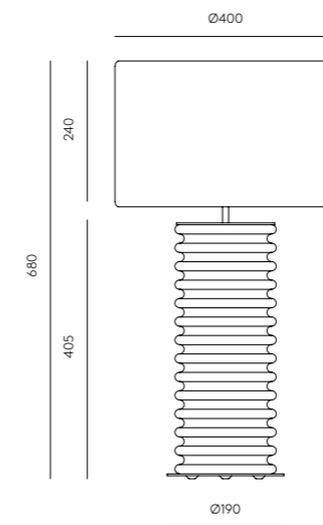

SHADOW

Table lamp

NAC112

Designed by AC Studio, 2019

DESCRIPTION

MATERIALS

Steel / Glass

FINISHES

Metal: Matt black / Matt white
Matt Brass / Shiny Gold / Chrome

Glass:
Clear

IMAGE SHADE 801011/36

Not included

SPECIFICATIONS (UE)

E27 Max. 60W (Not included)
220-240 V, 50/60 Hz,
IP20, Class II

ENERGY LABEL

A ++



MATERIALES

Acero / Vidrio

ACABADOS

Metal: Negro mate/ Blanco mate / Oro mate o brillo/ Cromo

Vidrio:
Transparente

PANTALLA IMAGEN 801011/36

No incluida

ESPECIFICACIONES (UE)

E27 Max. 60W (no incluida)
220-240 V, 50/60 Hz,
IP20, Clase II

ETIQUETA ENERGÉTICA

A ++



TECHNICAL

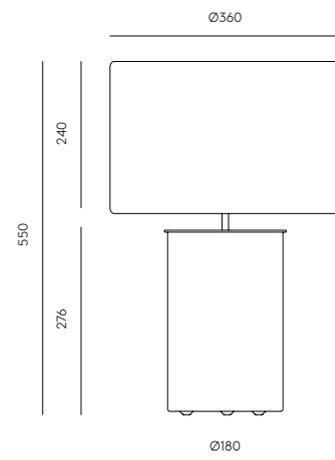

NOA

Table lamp

NAC110

Designed by AC Studio, 2016

DESCRIPTION

MATERIALS

Steel / Ceramic

FINISHES

Metal: Matt black / Matt white
Matt Brass / Shiny Gold / Chrome

Ceramics (Hand Painted):
See colour palette.

Image color: Make up

IMAGE SHADE 801011/41

Not included

SPECIFICATIONS (UE)

E27 Max. 60W LED (not included)
220-240 V, 50/60 Hz,
IP20, Class II

DIMMABLE OPTION

B211 11W (Dimmable) + Dimmer
(ask for extra cost)

ENERGY LABEL

A ++



MATERIALES

Acero / Cerámica

ACABADOS

Metal: Negro mate/ Blanco mate
Oro mate o brillo/ Cromo

Cerámica (Pintada a mano):
Consultar paleta de colores

Color de la imagen: Maquillaje

PANTALLA IMAGEN 801011/41

No incluida

ESPECIFICACIONES (UE)

E27 Max. 60W LED (no incluida)
220-240 V, 50/60 Hz,
IP20, Clase II

POSIBILIDAD REGULACIÓN

B211 11W (Regulable) + Regulador
(sobrecoste a consultar)

ETIQUETA ENERGÉTICA

A ++

TECHNICAL

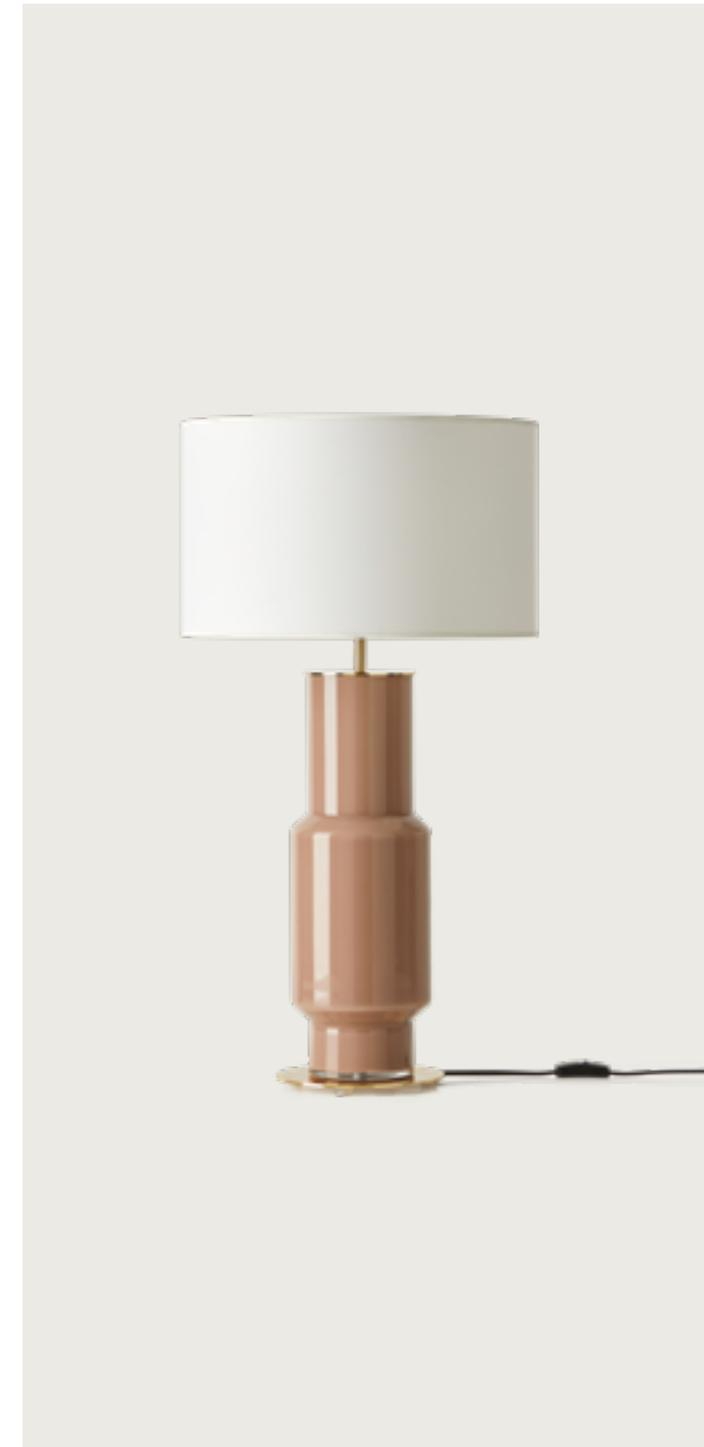
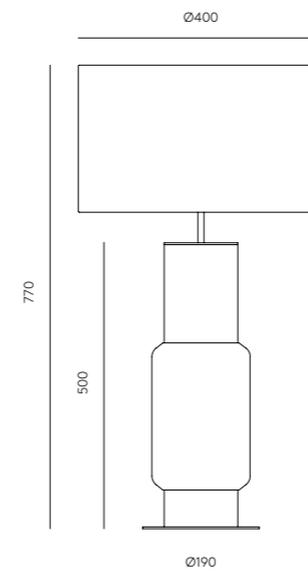



PONN PONN

Table lamp

NAC109

Designed by AC Studio, 2016

DESCRIPTION

MATERIALS

Steel / Glass / Leather

FINISHES

Metal: Matt black / Matt white
Matt Brass / Shiny Gold / Chrome

Glass (Hand Painted):
See colour palette.

Image color:
Left: Ash grey / Nude
Right: Light violet / Mineral red

IMAGE SHADE 801011/41

Not included

SPECIFICATIONS (UE)

E27 Max. 60W (Not included)
220-240 V, 50/60 Hz,
IP20, Class II

DIMMABLE OPTION

B211 11W (Dimmable) + Dimmer
(ask for extra cost)

ENERGY LABEL

A ++

IP20 CE RoHS REACH

MATERIALES

Acero / Vidrio / Piel

ACABADOS

Metal: Negro mate/ Blanco mate
Oro mate o brillo/ Cromo

Vidrio (Pintado a mano):
Consultar paleta de colores

Color de la imagen:
Izda. Gris ceniza / Nude
Dcha. Violeta claro/Rojo mineral

PANTALLA IMAGEN 801011/41

No incluida

ESPECIFICACIONES (UE)

E27 Max. 60W (no incluida)
220-240 V, 50/60 Hz,
IP20, Clase II

POSIBILIDAD REGULACIÓN

B211 11W (Regulable) + Regulador
(sobrecoste a consultar)

ETIQUETA ENERGÉTICA

A ++

TECHNICAL

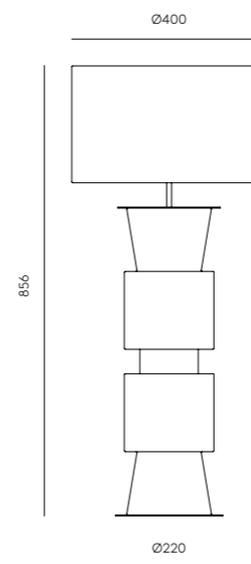

KITTA KITTA

Table lamp

NAC108

Designed by AC Studio, 2016

DESCRIPTION

MATERIALS

Steel / Glass / Leather

FINISHES

Metal: Matt black / Matt white
Matt Brass / Shiny Gold / Chrome

Glass (Hand Painted):
See colour palette.

Image color:

Up Sand Brown,
Down Green Leaf

IMAGE SHADE 801011/41

Not included

SPECIFICATIONS (UE)

E27 Max. 60W (Not included)
220-240 V, 50/60 Hz,
IP20, Class II

DIMMABLE OPTION

B211 11W (Dimmable) + Dimmer
(ask for extra cost)

ENERGY LABEL

A ++

IP20 CE    

MATERIALES

Acero / Vidrio / Piel

ACABADOS

Metal: Negro mate/ Blanco
mate / Oro mate o brillo/ Cromo

Vidrio (Pintado a mano):
Consultar paleta de colores

Color de la imagen:

Arriba Arena Marrón /
Abajo Verde hoja

PANTALLA IMAGEN 801011/41

No incluida

ESPECIFICACIONES (UE)

E27 Max. 60W (no incluida)
220-240 V, 50/60 Hz,
IP20, Clase II

POSIBILIDAD REGULACIÓN

B211 11W (Regulable) + Regulador
(sobrecoste a consultar)

ETIQUETA ENERGÉTICA

A ++

TECHNICAL

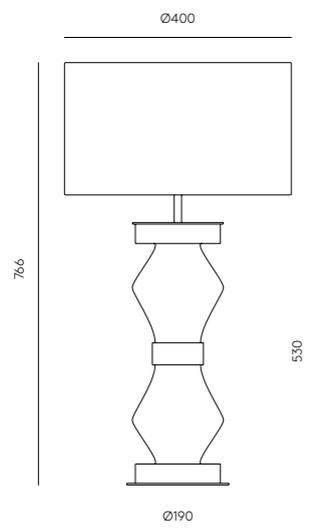

KITTA PONN

Table lamp

NAC107

Designed by AC Studio, 2016

DESCRIPTION

MATERIALS

Steel / Glass / Leather

FINISHES

Metal: Matt black / Matt white
Matt Brass / Shiny Gold / Chrome

Glass (Hand Painted):
See colour palette.

Image color:

Up Ash grey /
Down brown vintage

IMAGE SHADE 801011/40

Not included

SPECIFICATIONS (UE)

E27 Max. 60W (Not included)
220-240 V, 50/60 Hz,
IP20, Class II

DIMMABLE OPTION

B211 11W (Dimmable) + Dimmer
(ask for extra cost)

ENERGY LABEL

A ++

IP20 CE    

MATERIALES

Acero / Vidrio / Piel

ACABADOS

Metal: Negro mate/ Blanco
mate / Oro mate o brillo/ Cromo

Vidrio (Pintado a mano):
Consultar paleta de colores

Color de la imagen:

Arriba gris ceniza / Abajo marrón
vintage

PANTALLA IMAGEN 801011/40

No incluida

ESPECIFICACIONES (UE)

E27 Max. 60W (no incluida)
220-240 V, 50/60 Hz,
IP20, Clase II

POSIBILIDAD REGULACIÓN

B211 11W (Regulable) + Regulador
(sobrecoste a consultar)

ETIQUETA ENERGÉTICA

A ++

TECHNICAL

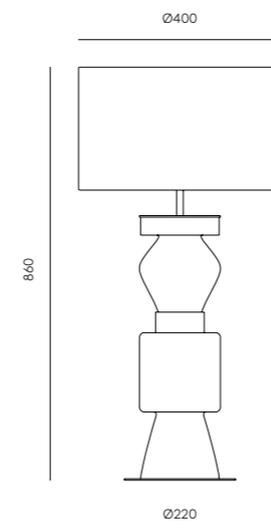

PONN

Table lamp

NAC106

Designed by AC Studio, 2016

DESCRIPTION

MATERIALS

Steel / Ceramic

FINISHES

Metal: Matt black / Matt white
Matt Brass / Shiny Gold / Chrome

Ceramics (Hand Painted):
See colour palette.

Image color: Mineral red

IMAGE SHADE 801011/36

Not included

SPECIFICATIONS (UE)

E27 Max. 60W LED (not included)
220-240 V, 50/60 Hz,
IP20, Class II

DIMMABLE OPTION

B211 11W (Dimmable) + Dimmer
(ask for extra cost)

ENERGY LABEL

A ++



MATERIALES

Acero / Cerámica

ACABADOS

Metal: Negro mate/ Blanco mate
/ Oro mate o brillo / Cromo

Cerámica (Pintada a mano):
Consultar paleta de colores

Color de la imagen: Mineral rojo

PANTALLA IMAGEN 801011/36

No incluida

ESPECIFICACIONES (UE)

E27 Max. 60W LED (no incluida)
220-240 V, 50/60 Hz,
IP20, Clase II

POSIBILIDAD REGULACIÓN

B211 11W (Regulable) + Regulador
(sobrecoste a consultar)

ETIQUETA ENERGÉTICA

A ++

TECHNICAL

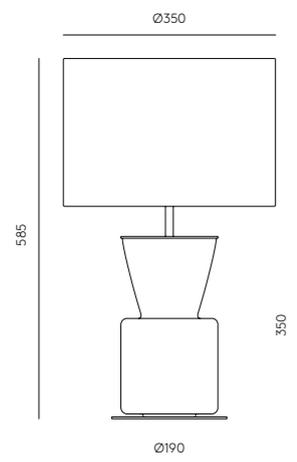

LUSA

Table lamp

NAC104

Designed by AC Studio, 2016

DESCRIPTION

MATERIALS

Steel / Ceramic

FINISHES

Metal: Matt black / Matt white
Matt Brass / Shiny Gold / Chrome

Ceramics (Hand Painted):
See colour palette.

Image color: Opal Violet

IMAGE SHADE 801011/41

Not included

SPECIFICATIONS (UE)

E27 Max. 60W LED (not included)
220-240 V, 50/60 Hz,
IP20, Class II

DIMMABLE OPTION

B211 11W (Dimmable) + Dimmer
(ask for extra cost)

ENERGY LABEL

A ++



MATERIALES

Acero / Cerámica

ACABADOS

Metal: Negro mate/ Blanco
mate / Oro mate o brillo/ Cromo

Cerámica (Pintada a mano):
Consultar paleta de colores

Color de la imagen: Violeta Opal

PANTALLA IMAGEN 801011/41

No incluida

ESPECIFICACIONES (UE)

E27 Max. 60W LED (no incluida)
220-240 V, 50/60 Hz,
IP20, Clase II

POSIBILIDAD REGULACIÓN

B211 11W (Regulable) + Regulador
(sobrecoste a consultar)

ETIQUETA ENERGÉTICA

A ++

TECHNICAL

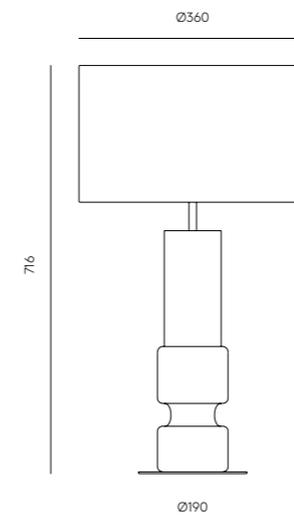

MELLY

Table lamp

NAC103

Designed by AC Studio, 2015

DESCRIPTION

MATERIALS
Steel / Glass

FINISHES

Metal: Matt black / Matt white
Matt Brass / Shiny Gold / Chrome

Glass (Hand Painted):
See colour palette.

Image color: Green leaf

IMAGE SHADE 151011/45
Not included

SPECIFICATIONS (UE)

E27 Max. 60W (Not included)
220-240 V, 50/60 Hz,
IP20, Class II

DIMMABLE OPTION

B211 11W (Dimmable) + Dimmer
(ask for extra cost)

ENERGY LABEL

A ++



MATERIALES
Acero / Vidrio

ACABADOS

Metal: Negro mate / Blanco
mate / Oro mate o brillo /Cromo

Vidrio (Pintado a mano):
Consultar paleta de colores

Color de la imagen: Verde hoja

PANTALLA IMAGEN 151011/45
No incluida

ESPECIFICACIONES (UE)

E27 Max. 60W (no incluida)
220-240 V, 50/60 Hz,
IP20, Clase II

POSIBILIDAD REGULACIÓN

B211 11W (Regulable) + Regulador
(sobrecoste a consultar)

ETIQUETA ENERGÉTICA

A ++

TECHNICAL

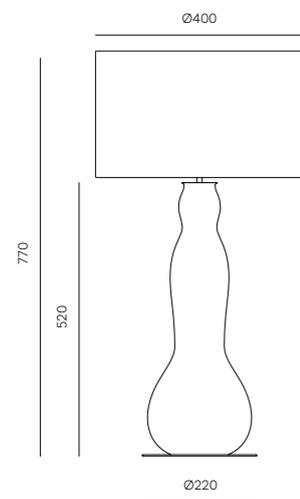

SAM

Table lamp

NAC093

Designed by AC Studio, 2013

DESCRIPTION

MATERIALS
Steel / Glass / Wood

FINISHES

Wood: Walnut

Glass: See colour palette.

Image color: Brown / Blue

IMAGE SHADE 801011/46
Not included

SPECIFICATIONS (UE)

E27 Max. 60W (Not included)
220-240 V, 50/60 Hz,
IP20, Class II

DIMMABLE OPTION

B211 11W (Dimmable) + Dimmer
(ask for extra cost)

ENERGY LABEL

A ++



MATERIALES
Acero / Vidrio / Madera

ACABADOS

Madera: Nogal

Vidrio: Ver paleta de colores

Color de la imagen: Marrón/Azul

PANTALLA IMAGEN 801011/46
No incluida

ESPECIFICACIONES (UE)

E27 Max. 60W (no incluida)
220-240 V, 50/60 Hz,
IP20, Clase II

POSIBILIDAD REGULACIÓN

B211 11W (Regulable) + Regulador
(sobrecoste a consultar)

ETIQUETA ENERGÉTICA

A ++

TECHNICAL

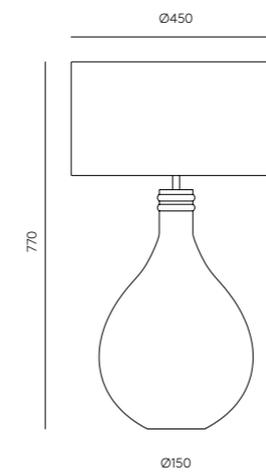



Pendant

Lamps

- 108 **TURA** · C1313
- 110 **ELMA** · C1312/S
- 113 **ELMA** · C1312/L
- 114 **ELLI** · C1311
- 116 **ELLI** · C1311/L
- 118 **DOUL** · C1310
- 120 **DOUL** · C1310/5
- 121 **TANA** · C1309/4
- 124 **TUYA** · C1308
- 126 **DUSSA** · C1307
- 127 **DUSSA** · C1307/6
- 130 **BION** · C1306/6
- 132 **STRIP** · C1303
- 133 **LEVEL** · C1302
- 134 **GRUYE** · C1301
- 137 **ICONIC** · C1300
- 138 **ONETA** · C1299
- 139 **ONETA-L** · C1299/L
- 140 **ISON** · C1298
- 141 **ISON** · C1298/5
- 144 **YCRO** · C1297
- 146 **TUBE** · C1296
- 147 **PIPE** · C1293
- 148 **ARC** · C1292
- 149 **PORTA-L** · C1290/L
- 150 **HAT** · C1291
- 152 **HAT** · C1291/S
- 154 **MIRO** · C1289
- 155 **MIRO** · C1289/6
- 156 **FITO** · C1286
- 157 **FITO-L** · C1286/L
- 158 **AMBOR** · C1283
- 159 **HUP** · C1282
- 160 **ATIL** · C1281
- 161 **ATIL** · C1281/6
- 164 **DALT** · C1280/6
- 165 **DALT** · C1280
- 166 **FOCUS** · C1279
- 168 **FOCUS** · C1279/4
- 169 **FOCUS** · C1279/1
- 170 **NOOI** · C1276
- 173 **NINO** · C1275
- 174 **LYB** · C1274
- 175 **COLN** · C1267
- 176 **GAND** · C1271
- 178 **CLIP** · C1265
- 180 **TERA** · C1260
- 182 **ABBACUS** · C1258
- 183 **ABBACUS** · C1258/1
- 184 **ERTO** · C1257/5
- 186 **FRAME** · C1246
- 188 **MAHO** · C1254/6
- 189 **OHLALA** · C1242
- 190 **CRANE** · C1241
- 191 **LUCA** · C1238
- 192 **LUCA+** · C1239/3
- 194 **LOTA** · C1235
- 196 **LITA** · C1230
- 197 **LITA** · C1230/4
- 198 **NERA SIX** · C1229/6
- 199 **NERA** · C1229
- 200 **DORA** · C1228
- 202 **ALOA** · C1227
- 203 **ALOA** · C1227/4
- 204 **DELIE** · C1224
- 205 **DELIE** · C1224/8
- 206 **FEST** · C1223
- 207 **HELMET** · C1221
- 208 **YOYO** · C1222
- 210 **LIND** · C1220
- 212 **BALL** · C1215
- 214 **ATOM** · C1214/8
- 215 **CUBE-X** · C1213
- 216 **MIKA** · C1204
- 217 **MIKA MULTI** · C1204/8
- 218 **BIGCOSS** · C1203/80
- 220 **ANET** · C1206
- 221 **MARU** · C1194
- 222 **DAMO** · C1191
- 223 **ELLA** · C1158
- 224 **ENDO** · C1156
- 227 **CHAPEAU** · C1157
- 228 **CORA** · C1129
- 230 **PTAN** · C1154
- 231 **COPO** · C1085
- 232 **BELL** · C1084
- 234 **ALPHA** · C1083
- 235 **BETA** · C1082
- 236 **GAMMA** · C1081
- 238 **ELLEN** · C1048
- 239 **CRAWFORD** · C1047
- 240 **DISC** · C1038
- 241 **OPEN** · C1034
- 242 **C1012** · C1012
- 243 **ANYA** · C1110 + 1143/1144
- 244 **DOUL** · T1310
- 245 **YCRO** · T1297
- 246 **YCRO** · T1297/4
- 248 **FOCUS** · T1279
- 249 **NOON** · T1278/1
- 250 **NOON** · T1278/3
- 251 **NOON** · T1278
- 254 **LATTO** · T1268
- 256 **TAMB 30-50** · T1019/30/50
- 257 **TAMB SQUARE** · T1016

TURA

C1313

Designed by JF Sevilla, 2023

DESCRIPTION

MATERIALS

Steel / Leather

FINISHES

Metal:
Matt black

Leather:
Black / Brown / Orange

SPECIFICATIONS

6 x LED chip 5W 2700K
dimmable
wired dimmer
24V, 50/60Hz
IP20, Class II

ENERGY LABEL

A ++

IP20 CE   

MATERIALES

Metal / Cuero

ACABADOS

Metal:
Negro mate

Cuero:
Negro / Marrón / Naranja

ESPECIFICACIONES

6 x Chip LED 5W 2700K
Regulable
Regulador en cable
24V, 50/60 Hz
IP20, Clase II

ETIQUETA ENERGÉTICA

A ++

TECHNICAL

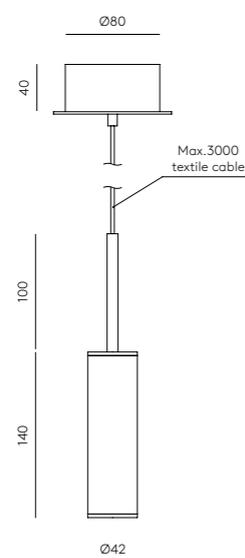

ELMA



Athens, Greece



ELLI

Pendant lamp

C1311/S

Designed by JF Sevilla, 2023

DESCRIPTION

MATERIALS

Metal / Acrylic

FINISHES

Metal: Matte Black / Antique Gold

Acrylic: - Opal

SPECIFICATIONS

LED chip 5W 2700K TRIAC dimmable

24V, 50/60Hz

IP20, Class I

ENERGY LABEL

A ++

MATERIALES

Metal / Acrílico

ACABADOS

Metal: Negro mate / Oro

envejecido

Acrílico: - Opal

ESPECIFICACIONES

Chip LED 5W 2700K TRIAC

regulable

24V, 50/60 Hz

IP20, Clase I

ETIQUETA ENERGÉTICA

A ++

IP20 CE

TECHNICAL

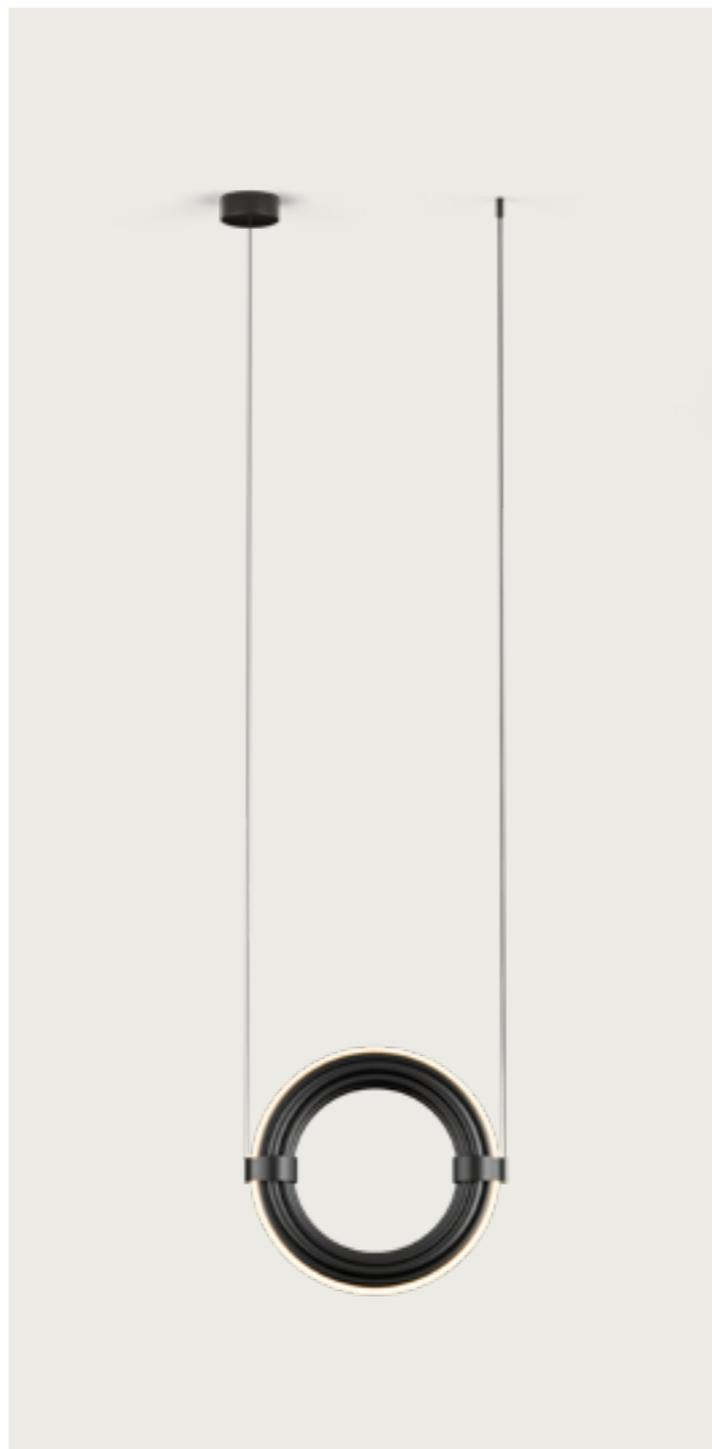
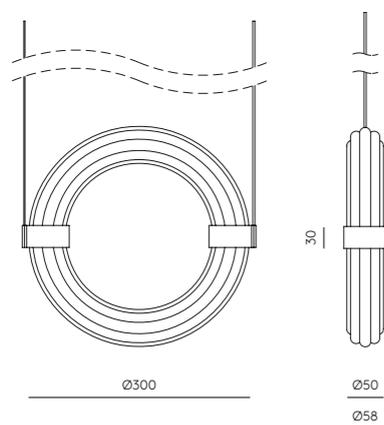

Århus, Denmark

ELLI

Pendant lamp

C1311/L
Designed by JF Sevilla, 2023

DESCRIPTION

MATERIALS
Metal / Acrylic

FINISHES
Metal: Matte Black / Antique Gold
Acrylic - Opal

SPECIFICATIONS
LED strip 30W DALI/PUSH CCT
dimable (adjust power and
temperature)
24V, 50/60Hz
IP20, Class I

ENERGY LABEL
A ++

MATERIALES
Metal / Acrílico

ACABADOS
Metal: Negro mate / Oro
envejecido
Acrílico - Opal

ESPECIFICACIONES
Tira LED 30W DALI/PUSH CCT
regulable (ajusta potencia y
temperatura)
24V, 50/60 Hz
IP20, Clase I

ETIQUETA ENERGÉTICA
A ++

⊕ IP20 CE    

TECHNICAL

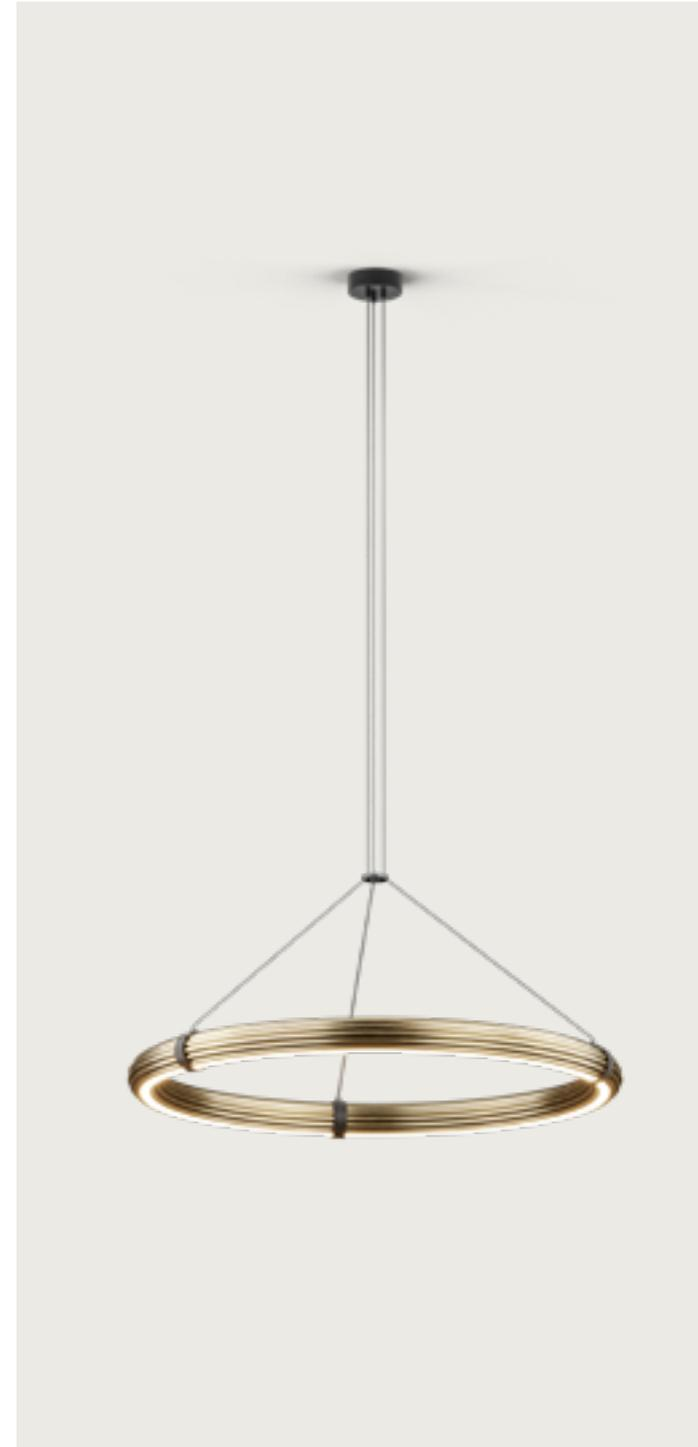
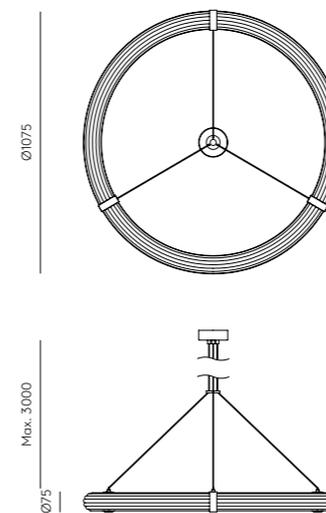

DOUL

Pendant lamp

C1310

Designed by Agus Gascón, 2023

DESCRIPTION

MATERIALS
Steel / Glass

FINISHES

Body: Matt black / Matt Brass
Glass: Striped glass - Transparent

SPECIFICATIONS (UE)

G4 LEDs 3W 2700K
Adjustable (Included)
Regulation on cable
220-240V, 50/60Hz
IP20, Class I

ENERGY LABEL

A ++



MATERIALES
Metal / Vidrio

ACABADOS

Cuerpo: Negro mate / Oro envejecido
Cristal: Cristal rayado - Transparente

ESPECIFICACIONES (UE)

G4 LED 3W 2700K
Regulable (Incluida)
Regulación en cable
220-240 V, 50/60 Hz
IP20, Clase I

ETIQUETA ENERGÉTICA

A ++

TECHNICAL

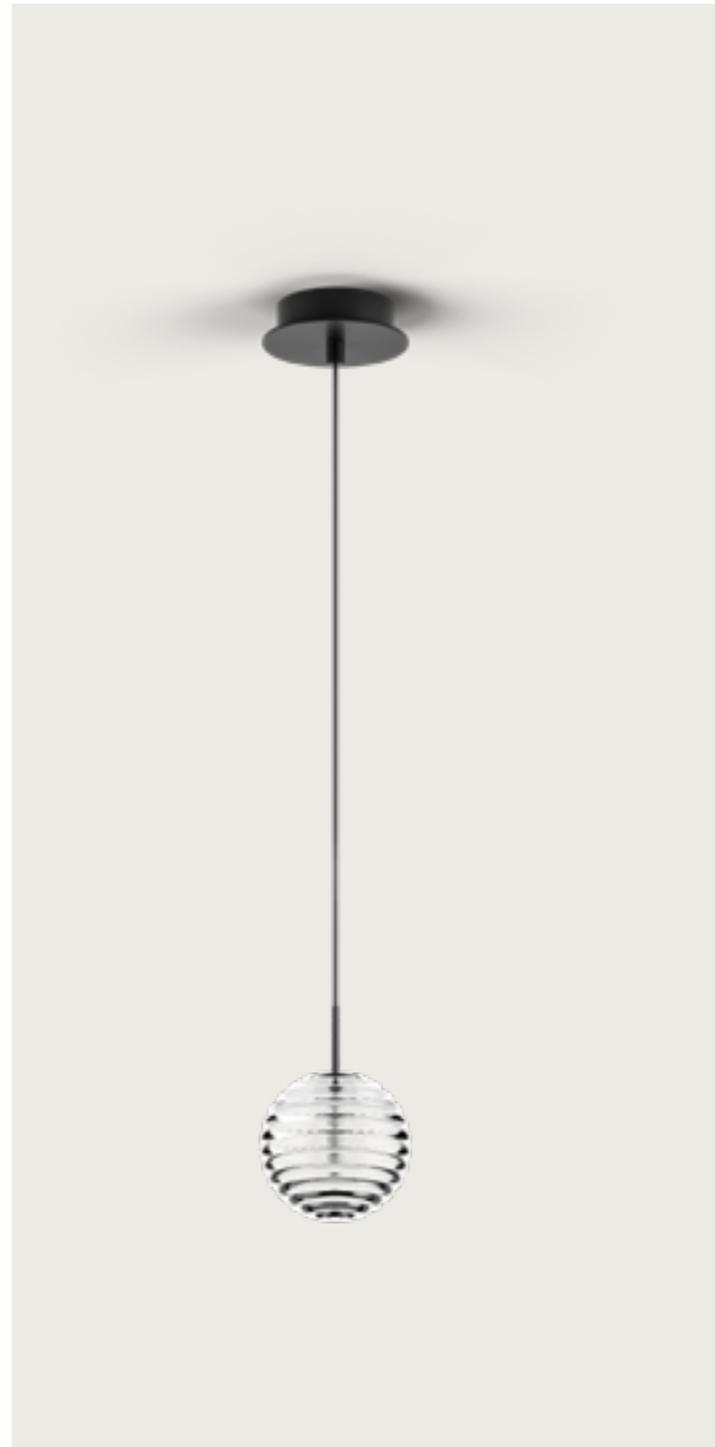
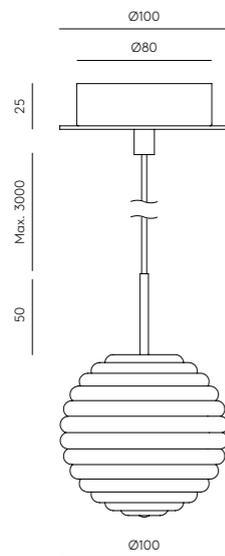

Paris, France

DOUL

C1310/5

Designed by Agus Gascón, 2023

DESCRIPTION

MATERIALS

Steel / Glass

FINISHES

Body:
Matt black / Matt Brass

Glass:
Striped glass - Transparent

SPECIFICATIONS (UE)

5 x G4 LEDs 3W 2700K
Dimmer (Included)
220-240V, 50/60Hz
IP20, Class I

ENERGY LABEL

A ++



MATERIALES

Metal / Vidrio

ACABADOS

Cuerpo:
Negro mate / Oro envejecido

Cristal:
Cristal rayado - Transparente

ESPECIFICACIONES (UE)

5 x G4 LED 3W 2700K
Regulable (Incluida)
220-240 V, 50/60 Hz
IP20, Clase I

ETIQUETA ENERGÉTICA

A ++

TECHNICAL

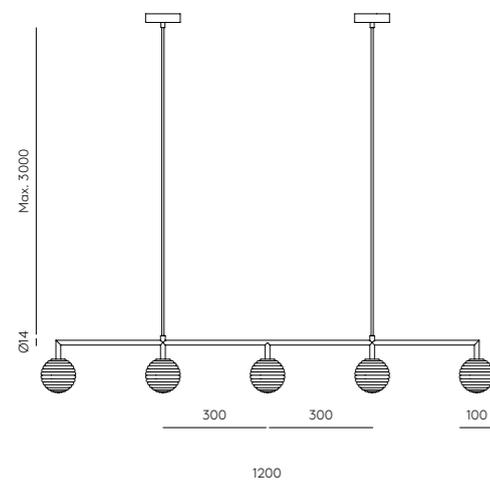

Berlin, Germany



TANA

Pendant lamp

C1309/4

Designed by JF Sevilla, 2022

DESCRIPTION

MATERIALS
Steel

FINISHES
Steel:
Matt black

SPECIFICATIONS
4x Chip LED 4W - 2700K
(Incluida)
Dimmer: Dali/Push - TRIAC
220-240V - 24V - 50/60 Hz
IP20 - Class I

ENERGY LABEL
A ++



MATERIALES
Metal

ACABADOS
Metal:
Negro mate

ESPECIFICACIONES
4x Chip LED 4W - 2700K
(Incluida)
Regulación: Dali/Push - TRIAC
220-240V - 24V - 50/60 Hz
IP20 - Clase I

ETIQUETA ENERGÉTICA
A ++

TECHNICAL

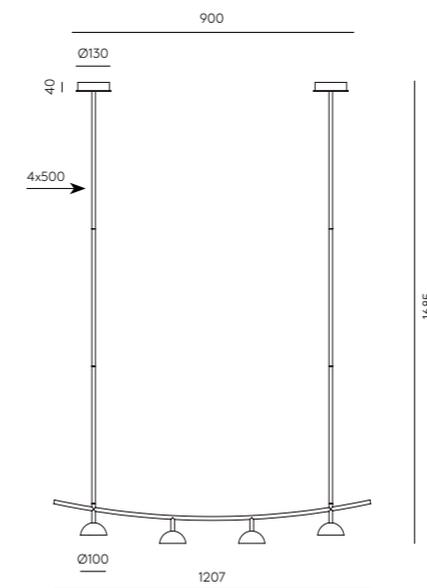

TUYA

C1308

Designed by JF Sevilla, 2022

DESCRIPTION

MATERIALS

Rattan / Steel / Acrylic

FINISHES

Rattan: Black

Metal: Antique Gold

Acrylic: Opal

SPECIFICATIONS

LED strip 20W - 2700K

TRIAC Dimmable

24V, 50/60Hz

IP20, Class I

ENERGY LABEL

A ++

IP20 CE RoHS ENEC

MATERIALES

Rattan / Acero / Acrílico

ACABADOS

Rattan: Negro

Metal: Oro envejecido

Acrílico: Opal

ESPECIFICACIONES

Tira LED 20W - 2700K

TRIAC Regulable

24 V, 50/60 Hz

IP20, Clase I

ETIQUETA ENERGÉTICA

A ++

TECHNICAL

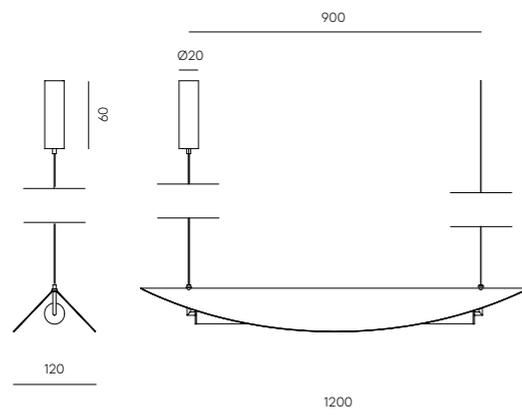

DUSSA

Pendant lamp

C1307

Designed by Pepe Fornas, 2022

DESCRIPTION

MATERIALS
Steel/Marble

MATERIALES
Metal / Mármol

FINISHES

Steel:
Matt black
Matt Brass

ACABADOS

Metal:
Negro mate
Oro envejecido

Marble:

Black
White
Travertine

Mármol:

Negro
Blanco
Travertino

SPECIFICATIONS

Led Plate 9W 2700K
Dimmer Dali-Push driver
24 V, 50/60 Hz
IP20 - Class II

ESPECIFICACIONES

Placa LED 9W - 2700K
Regulador por Dali-Push
24 V, 50/60 Hz
IP20, Clase II

ENERGY LABEL

A ++

ETIQUETA ENERGÉTICA

A ++

IP20 CE    A++

TECHNICAL

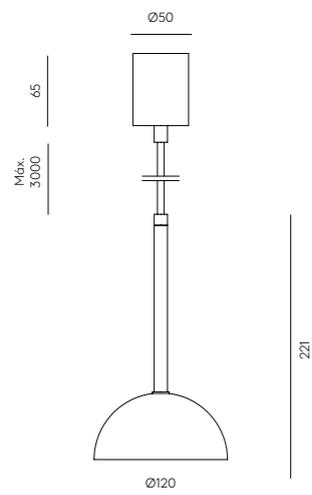

DUSSA

Pendant lamp

C1307/6

Designed by Pepe Fornas, 2022

DESCRIPTION

MATERIALS
Steel/Marble

MATERIALES
Metal / Mármol

FINISHES

Steel:
Matt black
Matt Brass

ACABADOS

Metal:
Negro mate
Oro envejecido

Marble:

Black
White
Travertine

Mármol:

Negro
Blanco
Travertino

SPECIFICATIONS

6 Led Plate 9W 2700K
Dimmer Dali-Push driver
24 V, 50/60 Hz
IP20 - Class II

ESPECIFICACIONES

6 Placa LED 9W - 2700K
Regulador por Dali-Push
24 V, 50/60 Hz
IP20, Clase II

ENERGY LABEL

A ++

ETIQUETA ENERGÉTICA

A ++

IP20 CE    A++

TECHNICAL

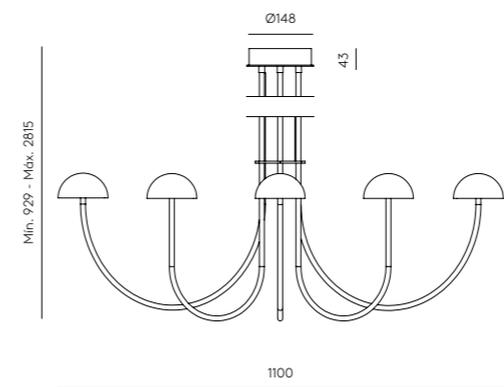

DUSSA



Vienna, Austria



Rotterdam, Netherlands

BION

Pendant lamp

C1306/6

Designed by Pepe Fornas, 2022



DESCRIPTION

MATERIALS
Steel

FINISHES

Body:
Matt black
Aged gold

Shade:
Matt black
Matt white

SPECIFICATIONS

6xG9 LED 5W 2700K
Dimmable (Included)
Possibility to dimmer
with Dali/Push driver
Interface (DALI/230V)
220-240 V, 50/60 Hz
IP20, Class II

ENERGY LABEL
A ++



MATERIALES
Metal

ACABADOS

Cuerpo:
Negro mate
Oro envejecido

Tulipa:
Negro mate
Blanco mate

ESPECIFICACIONES

6xG9 LED 5W 2700K
Regulable (Incluida)
Posibilidad de regulación
por Dali/Push
Interfaz (DALI/230V)
220-240 V, 50/60 Hz
IP20, Clase II

ETIQUETA ENERGÉTICA
A ++

TECHNICAL

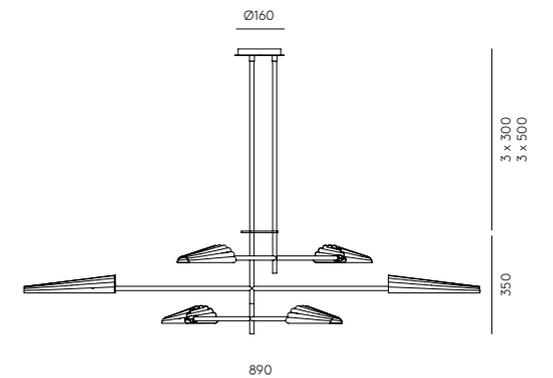

STRIP

Pendant lamp

C1303

Designed by AC Studio, 2022

DESCRIPTION

MATERIALS
Steel

FINISHES

Matt Black
Aged Gold
Anthracite
Rose Copper

SPECIFICATIONS

GU10 LED 5W- 2700K (incl.)
220-240V - 50/60 Hz
Class I - IP20

ENERGY LABEL

A ++

DIMMABLE OPTION

B161 (Dimmable) + Dimmer
Interface Dali/Push (Dali/230V)
(Ask for extra cost)

⊕ IP20 CE RoHS A++

MATERIALES
Metal

ACABADOS

Negro Mate
Oro envejecido
Antracita
Cobre Rosado

ESPECIFICACIONES

GU10 LED 5W - 2700K (incl.)
220-240V - 50/60 Hz
Clase I - IP20

ETIQUETA ENERGÉTICA

A ++

POSIBILIDAD REGULACIÓN

B161 (Regulable) + Regulador
Interfaz Dali/Push (Dali/230V)
(sobrecoste a consultar)

TECHNICAL

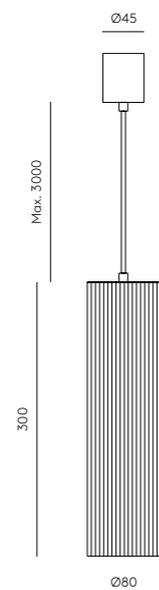

LEVEL

Pendant lamp

C1302

Designed by Pepe Fornas, 2022

DESCRIPTION

MATERIALS
Steel / Glass

FINISHES

Matt black
Aged Gold
Anthracite
Stripped glass clear
(consult us for other finishes)

SPECIFICATIONS

2xG9 LED 5W - 2700K (incl.)
220-240V - 50/60 Hz
Class I - IP20

ENERGY LABEL

A ++

DIMMABLE OPTION

2 x B005 (Dimmable) + Dimmer
Interface Dali/Push (Dali/230V)
(ask for extra cost)

⊕ IP20 CE RoHS A++

MATERIALES
Acero /Vidrio

ACABADOS

Metal:
Oro envejecido
Antracita
Vidrio:
Opal
Transparente Estriado
(consulte para otros acabados)

ESPECIFICACIONES

2xG9 LED 5W - 2700K (incl.)
220-240V - 50/60 Hz
IP20 - Clase I

ETIQUETA ENERGÉTICA

A ++

POSIBILIDAD REGULACIÓN

2x B005 (Regulable) + Regulador
Interfaz Dali/Push (Dali/230V)
(sobrecoste a consultar)

DESCRIPTION

MATERIALS
Steel / Glass

FINISHES

Matt black
Aged Gold
Anthracite
Stripped glass clear
(consult us for other finishes)

SPECIFICATIONS

2xG9 LED 5W - 2700K (incl.)
220-240V - 50/60 Hz
Class I - IP20

ENERGY LABEL

A ++

DIMMABLE OPTION

2 x B005 (Dimmable) + Dimmer
Interface Dali/Push (Dali/230V)
(ask for extra cost)

⊕ IP20 CE RoHS A++

TECHNICAL

MATERIALES
Acero /Vidrio

ACABADOS

Metal:
Oro envejecido
Antracita
Vidrio:
Opal
Transparente Estriado
(consulte para otros acabados)

ESPECIFICACIONES

2xG9 LED 5W - 2700K (incl.)
220-240V - 50/60 Hz
IP20 - Clase I

ETIQUETA ENERGÉTICA

A ++

POSIBILIDAD REGULACIÓN

2x B005 (Regulable) + Regulador
Interfaz Dali/Push (Dali/230V)
(sobrecoste a consultar)

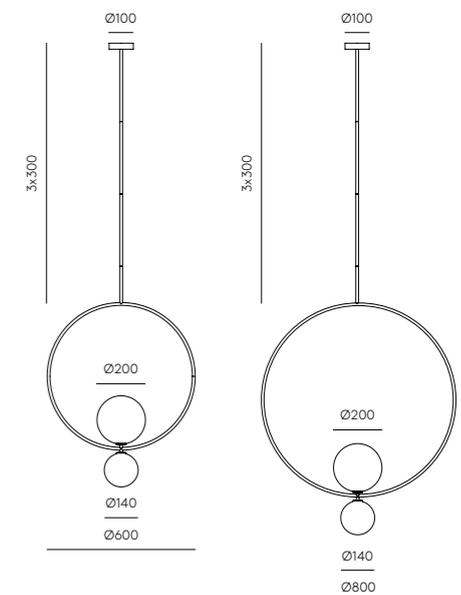

C1302/60

C1302/80



LEVEL



Málaga, Spain

GRUYE

Pendant lamp

C1301

Designed by Pepe Fornas, 2022



DESCRIPTION

MATERIALS
Steel / Glass

FINISHES

Metal:
Matt black
Aged Gold
Glass:
Opal

SPECIFICATIONS
4xG9 LED 5W - 2700K (incl.)
220-240V - 50/60 Hz
Class I - IP20

ENERGY LABEL
A ++

DIMMABLE OPTION
4 x B005 (Dimmable) + Dimmer
Interface Dali/Push (Dali/230V)
(ask for extra cost)

⊕ IP20 CE RoHS WEEE A++

MATERIALES
Acero / Vidrio

ACABADOS

Metal:
Oro envejecido
Antracita
Vidrio:
Opal

ESPECIFICACIONES
4xG9 LED 5W - 2700K (incl.)
220-240V - 50/60 Hz
IP20 - Clase I

ETIQUETA ENERGÉTICA
A ++

POSIBILIDAD REGULACIÓN
4 x B005 (Regulable) + Regulador
Interfaz Dali/Push (Dali/230V)
(sobrecoste a consultar)

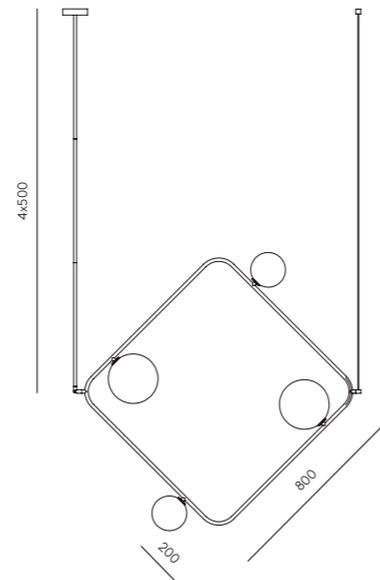

ICONIC

Pendant lamp

C1300

Designed by Agus Gascón, 2022

DESCRIPTION

MATERIALS
Steel / Marble

FINISHES

Metal:
Matt black
Aged Gold
Marble:
Finnish marble

SPECIFICATIONS
COB LED 7W 2700K
TRIAC Dimmable
220-240V - 24V - 50/60 Hz
Class I - IP20

ENERGY LABEL
A ++

⊕ IP20 CE RoHS WEEE A++

MATERIALES
Acero / Mármol

ACABADOS

Metal:
Negro Mate
Oro envejecido
Mármol:
Finlandés

ESPECIFICACIONES
Placa LED 7W 2700K
TRIAC Regulable
220-240V - 24V - 50/60 Hz
Clase I - IP20

ETIQUETA ENERGÉTICA
A ++

TECHNICAL

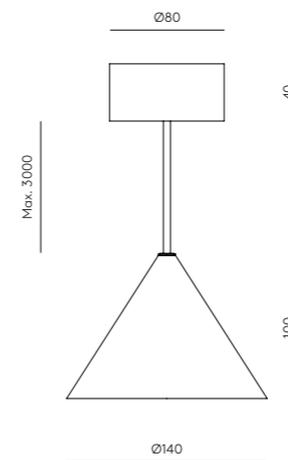

ONETA

Pendant lamp

C1299

Designed by Pepe Fornas, 2022

DESCRIPTION

MATERIALS

Steel / Marble / Glass

FINISHES

Metal: Matt black
Aged Gold

Marble: Matt White
Matt Black

Glass: Opal

SPECIFICATIONS

G4 LED 3W - 2700K (incl.)
Dimmable
220-240V - 50/60 Hz
Class I - IP20

ENERGY LABEL

A ++



MATERIALES

Acero / Marmol / Vidrio

ACABADOS

Metal: Oro envejecido
Antracita

Marmol: Negro Mate
Blanco Mate

Vidrio: Opal

ESPECIFICACIONES

G4 LED 3W - 2700K (incl.)
Regulable
220-240V - 50/60 Hz
Clase I - IP20

ETIQUETA ENERGETICA

A ++

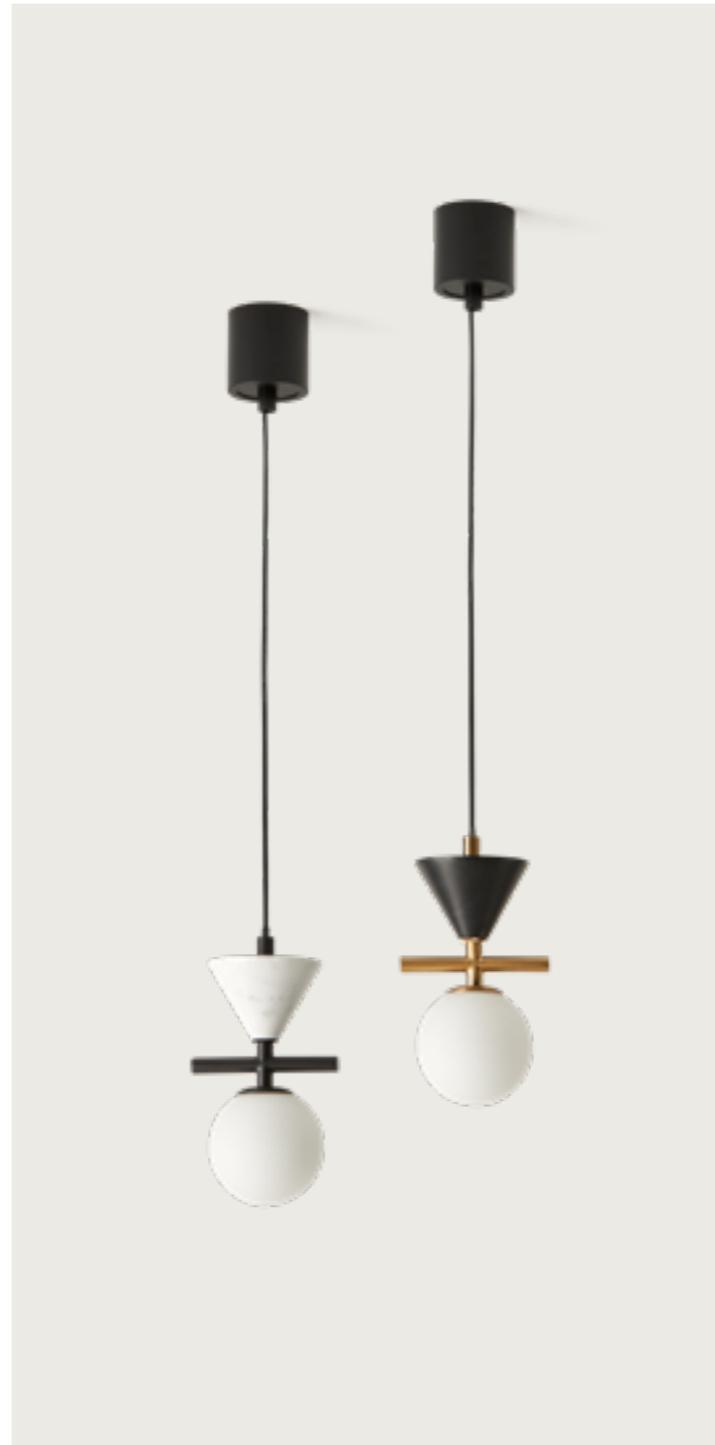

TECHNICAL

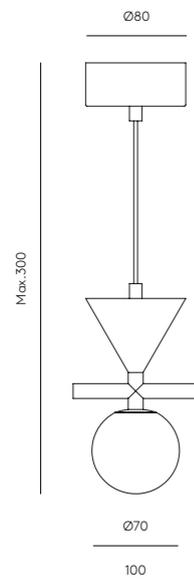

ONETA•L

Pendant lamp

C1299-L

Designed by Pepe Fornas, 2022



DESCRIPTION

MATERIALS

Steel / Marble / Glass

FINISHES

Metal: Matt black
Aged Gold

Marble: Matt White
Matt Black

Glass: Opal

SPECIFICATIONS

6x G4 LED 3W - 2700K (incl.)
TRIAC Dimmable
220-240V - 50/60 Hz
Class I - IP20

ENERGY LABEL

A ++



MATERIALES

Acero / Marmol / Vidrio

ACABADOS

Metal: Oro envejecido
Antracita

Marmol: Negro Mate
Blanco Mate

Vidrio: Opal

ESPECIFICACIONES

6x G4 LED 3W - 2700K (incl.)
TRIAC Regulable
220-240V - 50/60 Hz
Clase I - IP20

ETIQUETA ENERGETICA

A ++

TECHNICAL

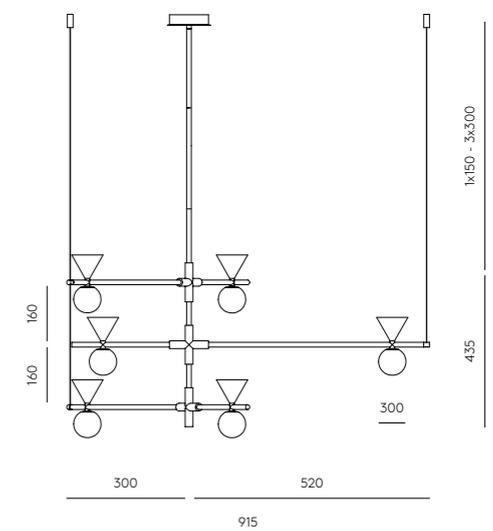

ISON

Pendant lamp

C1298

Designed by Pepe Fornas, 2022

DESCRIPTION

MATERIALS

Steel

FINISHES

Matt black
Matt gold

SPECIFICATIONS

Integrated LED stripe
8W - 2700K
Dimmable by TRIAC
220-240V - 24V - 50/60Hz
IP20 - Class I

ENERGY LABEL

A ++

⊕ IP20 CE   

MATERIALES

Acero

ACABADOS

Negro mate
Oro mate

ESPECIFICACIONES

Tira LED integrada
8W - 2700K
Regulable por TRIAC
220-240V - 24V - 50/60 Hz
IP20 - Clase I

ETIQUETA ENERGÉTICA

A ++

TECHNICAL

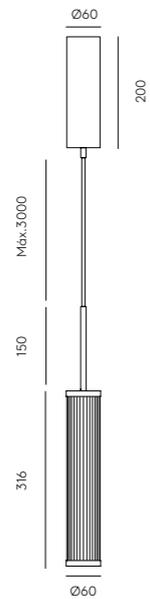

ISON

Pendant lamp

C1298/5

Designed by Pepe Fornas, 2021

DESCRIPTION

MATERIALS

Steel

FINISHES

Matt black
Matt gold

SPECIFICATIONS

5x Integrated LED stripe
8W - 2700K
Dimmable by TRIAC
220-240V - 24V - 50/60Hz
IP20 - Class I

ENERGY LABEL

A ++

⊕ IP20 CE   

MATERIALES

Acero

ACABADOS

Negro mate
Oro mate

ESPECIFICACIONES

5x Tira LED integrada
8W - 2700K
Regulable por TRIAC
220-240V - 24V - 50/60 Hz
IP20 - Clase I

ETIQUETA ENERGÉTICA

A ++

DESCRIPTION

MATERIALS

Steel

FINISHES

Matt black
Matt gold

SPECIFICATIONS

5x Integrated LED stripe
8W - 2700K
Dimmable by TRIAC
220-240V - 24V - 50/60Hz
IP20 - Class I

ENERGY LABEL

A ++

⊕ IP20 CE   

MATERIALES

Acero

ACABADOS

Negro mate
Oro mate

ESPECIFICACIONES

5x Tira LED integrada
8W - 2700K
Regulable por TRIAC
220-240V - 24V - 50/60 Hz
IP20 - Clase I

ETIQUETA ENERGÉTICA

A ++

TECHNICAL

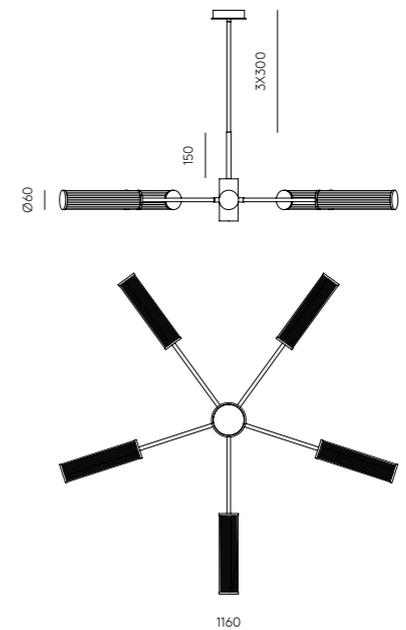

Goteborg, Sweden



ISON

YCRO

Pendant lamp

C1297

Designed by JF Sevilla, 2021

DESCRIPTION

MATERIALS

Steel

FINISHES

Matt black
Matt gold

SPECIFICATIONS

Chip LED 8W - 3000K
TRIAC Dimmable
220-240V - 50/60 Hz
Class I - IP20

ENERGY LABEL

A ++

⊕ IP20 CE   

MATERIALES

Acero

ACABADOS

Negro mate
Oro mate

ESPECIFICACIONES

Chip LED 8W - 3000K
TRIAC Regulable
220-240V - 24V - 50/60 Hz
IP20 - Clase I

ETIQUETA ENERGÉTICA

A ++

TECHNICAL

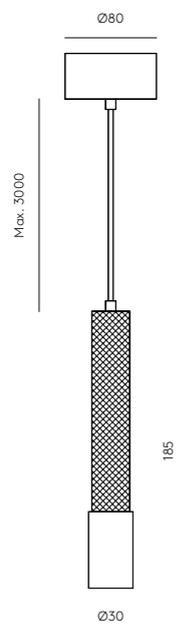

Belgrade, Serbia



TUBE

Pendant lamp

C1296

Designed by JF Sevilla, 2021



DESCRIPTION

MATERIALS

Steel / Acrylic

FINISHES

Metal:
Matt black
Matt gold

Acrylic:
Opal

SPECIFICATIONS

20W LED strip
2700K TRIAC Dimmable
24 V, 50/60 Hz
IP20, Class I

**STEEL WIRE FOR HORIZONTAL
USE INCLUDED**

ENERGY LABEL

A ++
⊕ IP20 CE RoHS ENEC

MATERIALES

Acero / Acrílico

ACABADOS

Metal:
Negro mate
Oro mate

Acrílico:
Opal

ESPECIFICACIONES

Tira LED 20W
2700K TRIAC Regulable
24 V, 50/60 Hz
IP20, Clase I

**STEEL WIRE FOR HORIZONTAL
USE INCLUDED**

ETIQUETA ENERGÉTICA

A ++

TECHNICAL

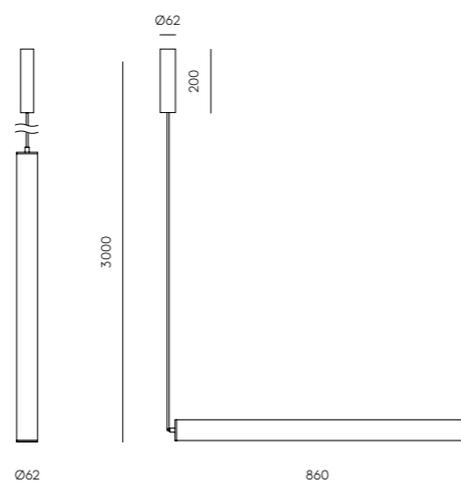

PIPE

Pendant lamp

C1293

Designed by AC Studio, 2021



DESCRIPTION

MATERIALS

Steel

FINISHES

Metal:
Matt black

SPECIFICATIONS

6 x GU10 3W, 3000K
TRIAC dimmable
(included) 230V, 50/60 Hz
IP20, Class I

ENERGY LABEL

A ++

⊕ IP20 CE RoHS ENEC

MATERIALES

Acero

ACABADOS

Metal:
Negro mate

ESPECIFICACIONES

6 x GU10 3W, 3000K
TRIAC regulable
(incluida) 230V, 50/60 Hz
IP20, Clase I

ETIQUETA ENERGÉTICA

A ++

TECHNICAL

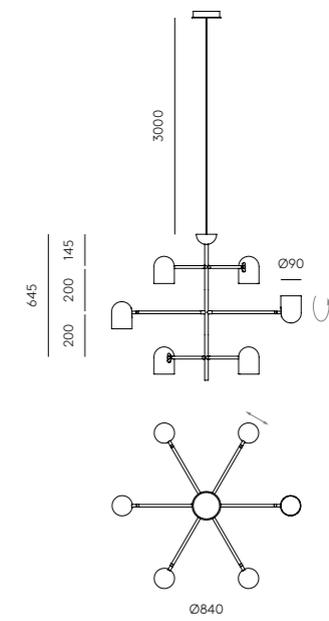

ARC

Pendant lamp

C1292

Designed by JF Sevilla, 2021



DESCRIPTION

MATERIALS
Steel / Acrylic

FINISHES

Metal:
Matt black
Matt gold

Acrylic:
Opal

SPECIFICATIONS
20W LED strip
2700K TRIAC Dimmable
24 V, 50/60 Hz
IP20, Class I

ENERGY LABEL
A ++



MATERIALES
Acero / Acrílico

ACABADOS

Metal:
Negro mate
Oro mate

Acrílico:
Opal

ESPECIFICACIONES
Tira LED 20W
2700K TRIAC Regulable
24 V, 50/60 Hz
IP20, Clase I

ETIQUETA ENERGÉTICA
A ++

TECHNICAL

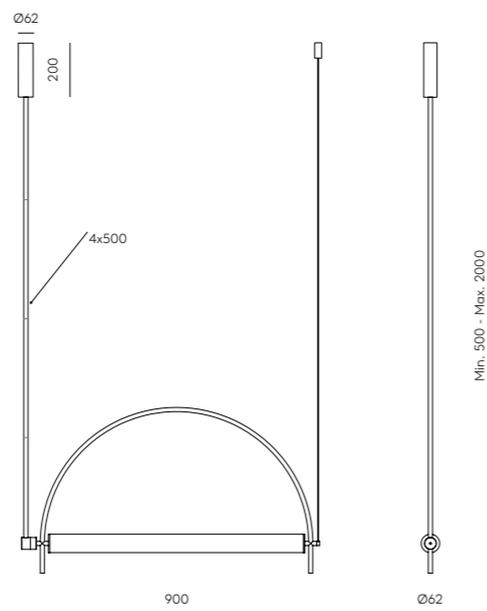

PORTA·L

Pendant lamp

C1290-L

Designed by Estudi Hac, 2021

DESCRIPTION

MATERIALS
Steel / Glass

FINISHES

Metal:
Matt black

Glass:
Smoked grey.

SPECIFICATIONS
9W LED plates
2700K TRIAC Dimmable
24 V, 50/60 Hz
IP20, Class I

ENERGY LABEL
A ++



MATERIALES
Acero / Vidrio

ACABADOS

Metal:
Negro mate

Vidrio:
Negro mate

ESPECIFICACIONES
Placas LED 9W
2700K TRIAC Regulable
24 V, 50/60 Hz
IP20, Clase I

ETIQUETA ENERGÉTICA
A ++

TECHNICAL

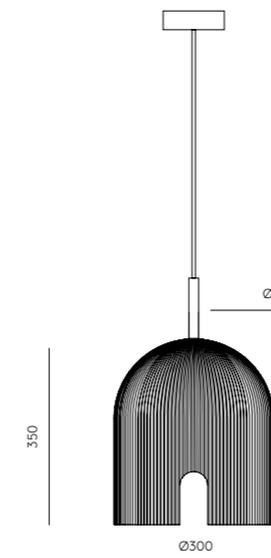



HAT

Pendant lamp

C1291

Designed by Pepe Fornas, 2021

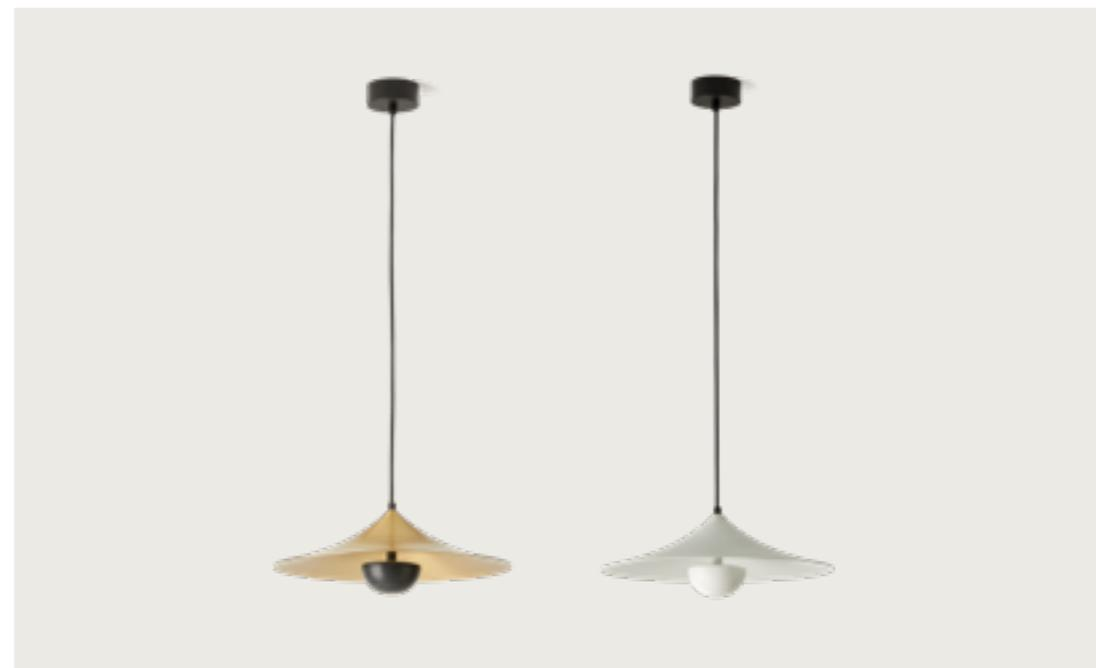

DESCRIPTION

MATERIALS

Steel / Marble / Acrylic

FINISHES

Metal:
Matt White
Matt Gold

Marble:
Matt black
Matt white

SPECIFICATIONS

9W LED plate
2700K TRIAC Dimmable
24 V, 50/60 Hz
IP20, Class I

ENERGY LABEL
A ++

⊕ IP20 CE    

MATERIALES

Acero / Mármol / Acrílico

ACABADOS

Metal:
Blanco Mate
Oro Mate

Mármol:
Negro mate
Blanco Mate

ESPECIFICACIONES

Placa LED 9W
2700K TRIAC Regulable
24 V, 50/60 HZ
IP20, Clase I

ETIQUETA ENERGÉTICA
A ++

TECHNICAL

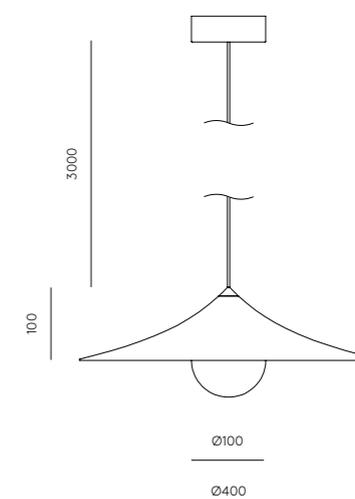

HAT

Pendant lamp

C1291/S

Designed by Pepe Fornas, 2022



DESCRIPTION

MATERIALS

Steel / Acrylic

FINISHES

Metal Shade:
Matt White
Matt Gold

SPECIFICATIONS

9W LED plate
2700K TRIAC Dimmable
24 V, 50/60 Hz
IP20, Class I

ENERGY LABEL

A ++



TECHNICAL

MATERIALES

Acero / Acrílico

ACABADOS

Tulipa Metal:
Blanco Mate
Oro Mate

ESPECIFICACIONES

Placa LED 9W
2700K TRIAC Regulable
24 V, 50/60 HZ
IP20, Clase I

ETIQUETA ENERGÉTICA

A ++

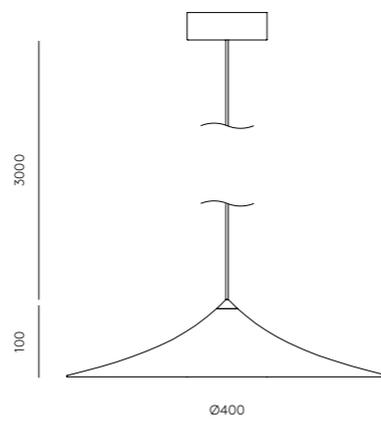

MIRO

Pendant lamp

C1289

Designed by AC Studio, 2021

DESCRIPTION

MATERIALS

Steel / Blown Glass

FINISHES

Metal: Matt black

Shade (included): Opal

Recommended Bulb:
B005/5W.

COMPATIBLE ACCESSORIES

(Not included in the price, choose one from list below)

Alabaster: 1096/35 · 1289/20/A

Ceramic: 1097/20 · 1097/30

Glass: 1223/25

Metalic disc: 1289/20

SPECIFICATIONS

G9 LED (included) 5W 2700K
220-240V, 50/60 Hz,
IP20, Clase I

ENERGY LABEL

A ++



MATERIALES

Acero / Vidrio Soplado

ACABADOS

Metal: Negro mate

Tulipa (incluidas): Opal

Bombilla recomendada:
B005/5W.

ACCESORIOS COMPATIBLES

(No incluido en el precio, elige uno de la siguiente lista)

Alabastro: 1096/35 · 1289/20/A

Cerámica: 1097/20 · 1097/30

Cristal: 1223/25

Disco Metal: 1289/20

ESPECIFICACIONES

G9 LED (incluido) 5W 2700K
24 V, 50/60 Hz,
IP20, Clase I

ETIQUETA ENERGÉTICA

A ++

TECHNICAL

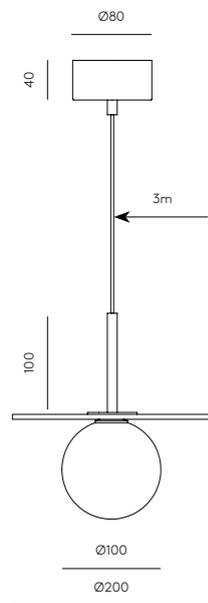

MIRO

Pendant lamp

C1289/6

Designed by AC Studio, 2021

DESCRIPTION

MATERIALS

Steel / Blown Glass

FINISHES

Metal: Matt black

Shades (included): Opal

Recommended Bulbs:
B005/5W

COMPATIBLE ACCESSORIES

(Not included in the price, choose one from list below)

Alabaster: 1096/35 · 1289/20/A

Ceramic: 1097/20 · 1097/30

Glass: 1223/25

Metalic disc: 1289/20

SPECIFICATIONS

6x G9 LED (included) 5W 2700K
220-240V, 50/60 Hz,
IP20, Clase I

ENERGY LABEL

A ++

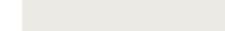

DESCRIPTION

MATERIALS

Steel / Blown Glass

FINISHES

Metal: Matt black

Shades (included): Opal

Recommended Bulbs:
B005/5W

COMPATIBLE ACCESSORIES

(Not included in the price, choose one from list below)

Alabaster: 1096/35 · 1289/20/A

Ceramic: 1097/20 · 1097/30

Glass: 1223/25

Metalic disc: 1289/20

SPECIFICATIONS

6x G9 LED (included) 5W 2700K
220-240V, 50/60 Hz,
IP20, Clase I

ENERGY LABEL

A ++



MATERIALES

Acero / Vidrio Soplado

ACABADOS

Metal: Negro mate

Tulipas (incluidas): Opal

Bombillas recomendada:
B005/5W

ACCESORIOS COMPATIBLES

(No incluido en el precio, elige uno de la siguiente lista)

Alabastro: 1096/35 · 1289/20/A

Cerámica: 1097/20 · 1097/30

Cristal: 1223/25

Disco Metal: 1289/20

ESPECIFICACIONES

6x G9 LED (incluido) 5W 2700K
24 V, 50/60 Hz,
IP20, Clase I

ETIQUETA ENERGÉTICA

A ++

TECHNICAL

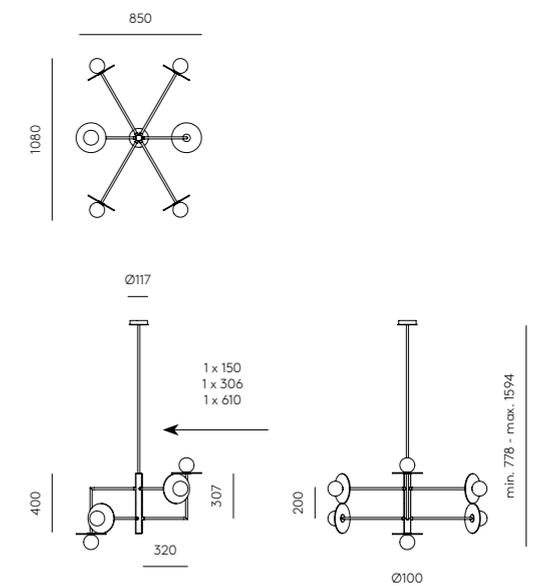

FITO

Pendant lamp

C1286

Designed by Pepe Fornas, 2020

DESCRIPTION

MATERIALS
Steel

FINISHES

Base:
Matt Brass
Rack:
Matt Black / Matt White
Rack tube sizes:
C1285/50 - 50 cm
C1285/25 - 25 cm
Recommended Bulb:
B050

SPECIFICATIONS

E27 (Bulb not included)
220-240 V, 50/60 Hz
IP20, Class II

ENERGY LABEL
A ++

MATERIALES
Acero

ACABADOS

Base:
Oro mate
Rejilla:
Negro mate / Blanco mate
Medidas tubo rejilla:
C1285/50 - 50 cm
C1285/25 - 25 cm
Bombilla recomendada:
B050

ESPECIFICACIONES

E27 (Bombilla no incluida)
220-240 V, 50/60 Hz
IP20, Clase II

ETIQUETA ENERGÉTICA
A ++

TECHNICAL

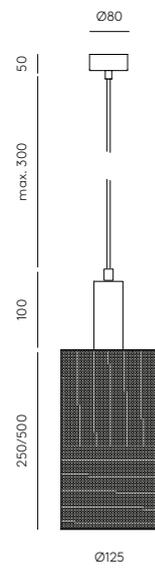

FITO-L

Pendant lamp

C1286/L

Designed by Pepe Fornas, 2022



DESCRIPTION

MATERIALS
Steel

FINISHES

Body:
Matt Black
Rack:
Matt Gold

SPECIFICATIONS

T8 LED 14W- 3000K. (incl.)
220-240V, 50/60 Hz
IP20, Class I

NOT DIMMABLE

ENERGY LABEL
A ++



MATERIALES
Acero

ACABADOS

Cuerpo:
Negro mate
Rejilla:
Oro mate

ESPECIFICACIONES

T8 LED 14W- 3000K. (incl.)
220-240V, 50/60 Hz
IP20, Clase I

NO REGULABLE

ETIQUETA ENERGÉTICA
A ++

TECHNICAL

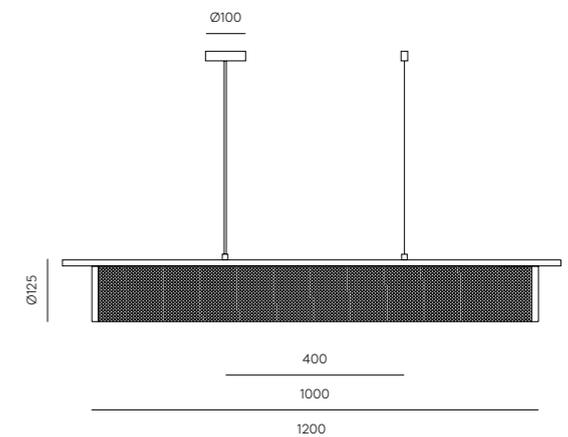

AMBOR

Pendant lamp

C1283

Designed by Pepe Fornas, 2019

DESCRIPTION

MATERIALS

Steel / Acrylic

FINISHES

Cable:
Matt Black

Shade:
Matt Brass
Matt Black

Diffuser:
Opal

SPECIFICATIONS

G9 Led Dimmable Bulbs
(Incl.) 3 x 3W - 3000K
220-240 V, 50/60 Hz
IP20, Class II

ENERGY LABEL

A ++

MATERIALES

Acero / Acrílico

ACABADOS

Cable:
Negro mate

Pantalla:
Oro mate
Negro mate

Difusor:
Opal

ESPECIFICACIONES

Bombillas G9 Led Regulables
(Incl.) 3 x 3W - 3000K
220-240 V, 50/60 Hz
IP20, Clase II

ETIQUETA ENERGÉTICA

A ++

TECHNICAL

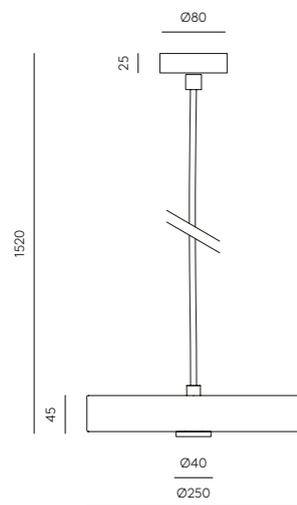

HUP

Pendant lamp

C1282

Designed by Pepe Fornas, 2019

DESCRIPTION

MATERIALS

Steel / Glass

FINISHES

Metal:
Matt Brass

Shade:
Opal

SPECIFICATIONS

E27 (Not included) Max. 60W
220-240 V, 50/60 Hz
IP20, Class I

RECOMMENDED BULB

B211 (7, 9, 11W)

ENERGY LABEL

A ++

MATERIALES

Acero / Vidrio

ACABADOS

Metal:
Oro mate

Pantalla:
Opal

ESPECIFICACIONES

E27 (No incluida) Max. 60W
220-240 V, 50/60 Hz
IP20, Clase I

BOMBILLA RECOMENDADA

B211 (7, 9, 11W)

ETIQUETA ENERGÉTICA

A ++

⊕ IP20 CE RoHS A++

TECHNICAL

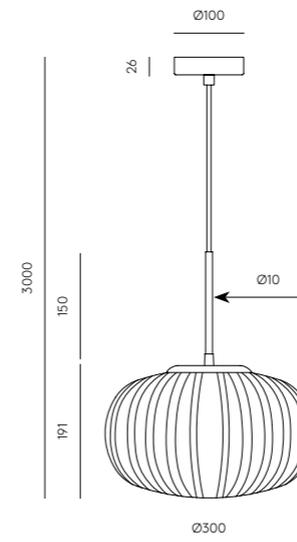

ATIL

Pendant lamp

C1281

Designed by Pepe Fornas, 2019

DESCRIPTION

MATERIALS
Steel / Glass

FINISHES

Metal:
Matt Black
Matt Brass
Shade:
Opal

SPECIFICATIONS

Bulbs G9 Led (Included)
5W - 2700K
220-240 V, 50/60 Hz
IP20, Class I

RECOMMENDED BULB
B005/5W

ENERGY LABEL
A ++

⊕ IP20 CE   

MATERIALES
Acero / Vidrio

ACABADOS

Metal:
Negro mate
Oro mate
Pantalla:
Opal

ESPECIFICACIONES

Bombillas G9 Led (Incluidas)
5W - 2700K
220-240 V, 50/60 Hz
IP20, Clase I

BOMBILLA RECOMENDADA
B005/5W

ETIQUETA ENERGÉTICA
A ++

TECHNICAL

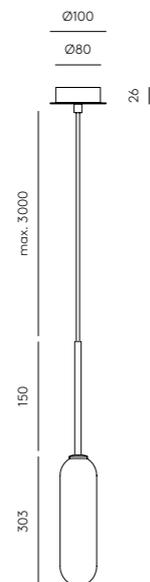

ATIL

Pendant lamp

C1281/6

Designed by Pepe Fornas, 2019

DESCRIPTION

MATERIALS
Steel / Glass

FINISHES

Metal:
Matt Black
Matt Brass (details)
Shade:
Opal

SPECIFICATIONS

Bulbs G9 Led (Included)
6x 5W - 2700K
220-240 V, 50/60 Hz
IP20, Class I

RECOMMENDED BULB
B005/5W

ENERGY LABEL
A ++

MATERIALES
Acero / Vidrio

ACABADOS

Metal:
Negro mate
Oro mate (Detalles)
Pantalla:
Opal

ESPECIFICACIONES

Bombillas G9 Led (Incluidas)
6x 5W - 2700K
220-240 V, 50/60 Hz
IP20, Clase I

BOMBILLA RECOMENDADA
B005/5W

ETIQUETA ENERGÉTICA
A ++

TECHNICAL

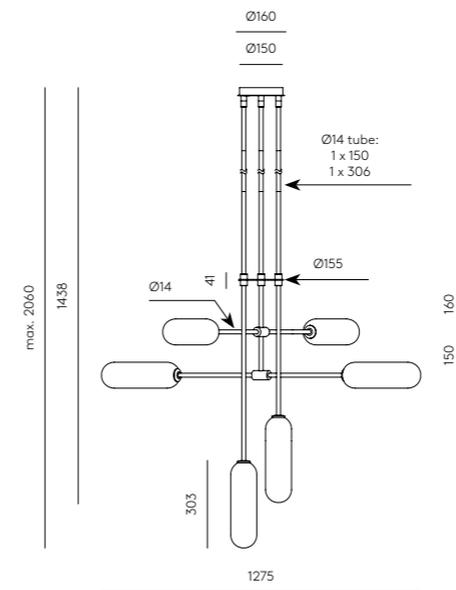



ATIL



London, United Kingdom

DALT

Pendant lamp

C1280/6

Designed by Pepe Fornas, 2019



DESCRIPTION

MATERIALS

Steel / Marble / Glass

FINISHES

Metal:

Matt Black / Aged Brass

Marble:

Black / Green

Shade:

Opal

POSSIBLE MODIFICATIONS

Marble finishes: White, black or green (extra cost)

SPECIFICATIONS

Bulbs G9 Led (Included)
6 x 5W - 2700K dimmable
220-240 V, 50/60 Hz
IP20, Class I

RECOMMENDED BULB

B005/5W

ENERGY LABEL

A ++



MATERIALES

Acero / Mármol / Vidrio

ACABADOS

Metal:

Negro mate / Oro envejecido

Mármol:

Negro / Verde

Pantalla:

Opal

MODIFICACIONES POSIBLES

Acabados Mármol: Blanco, negro o verde (coste extra)

ESPECIFICACIONES

Bombillas G9 Led (Incluidas)
6 x 5W - 2700K regulable
220-240 V, 50/60 Hz
IP20, Clase I

BOMBILLA RECOMENDADA

B005/5W

ETIQUETA ENERGÉTICA

A ++

TECHNICAL

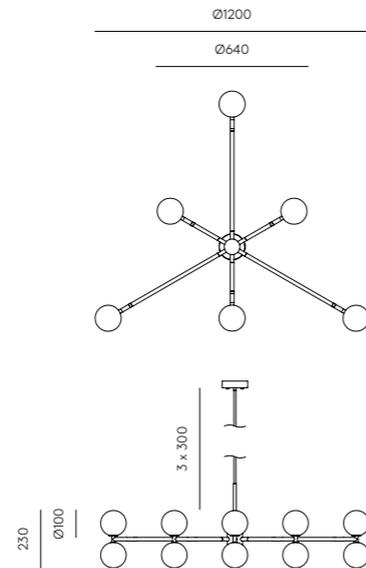

DALT

Pendant lamp

C1280

Designed by Pepe Fornas, 2019



DESCRIPTION

MATERIALS

Steel / Marble / Glass

FINISHES

Metal:

Matt Black / Aged Brass

Marble:

Black / Green / White

Shade:

Opal

SPECIFICATIONS

Bulb G9 Led (Included)
5W - 2700K dimmable
220-240 V, 50/60 Hz
IP20, Class I

RECOMMENDED BULB

B005/5W

ENERGY LABEL

A ++



MATERIALES

Acero / Mármol / Vidrio

ACABADOS

Metal:

Negro mate / Oro envejecido

Mármol:

Negro / Verde / Blanco

Pantalla:

Opal

ESPECIFICACIONES

Bombilla G9 Led (Incluidas)
5W - 2700K regulable
220-240 V, 50/60 Hz
IP20, Clase I

BOMBILLA RECOMENDADA

B005/5W

ETIQUETA ENERGÉTICA

A ++

TECHNICAL

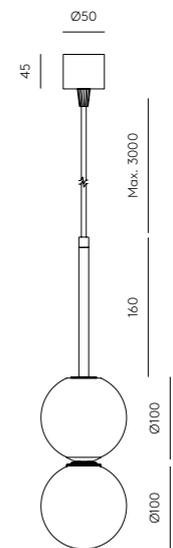

Zagreb, Croatia



FOCUS

Pendant lamp

C1279

Designed by Pepe Fornas, 2019

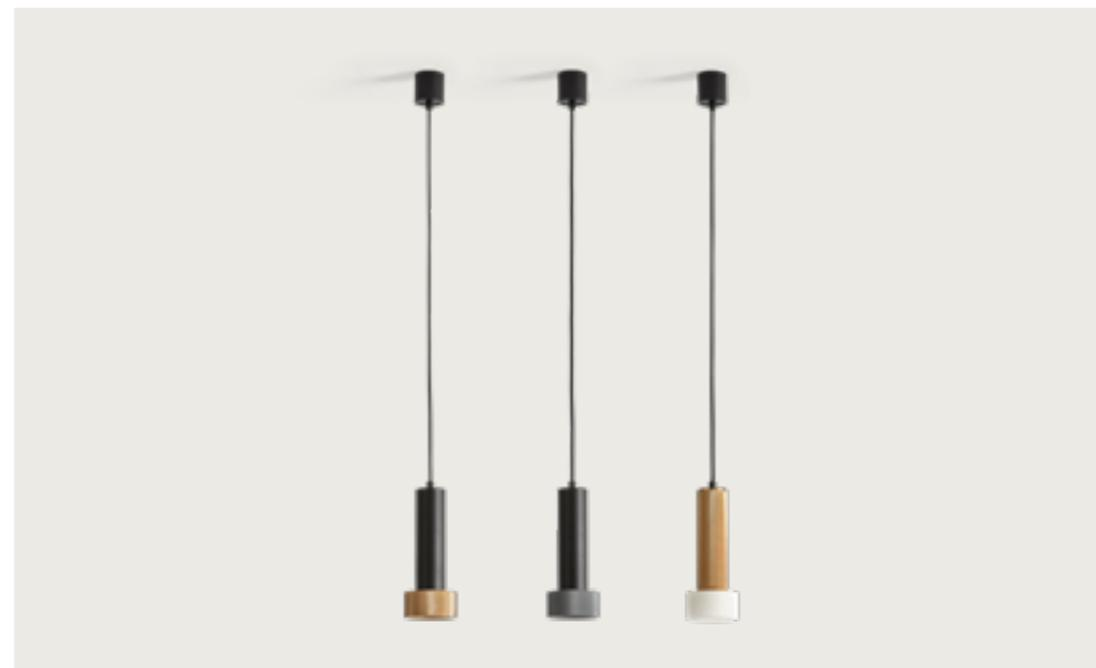

DESCRIPTION

MATERIALS

Steel / Aluminium or Alabaster

FINISHES

Body: Matt Black

Head: Aged gold, Anthracite, Matt black

POSSIBLE MODIFICATIONS

Alabaster head (Extra charge)

SPECIFICATIONS

Bulb GU10 Led (Included)
5W - 2700K
220-240 V, 50/60 Hz
IP20, Class I

RECOMMENDED BULB

B161

ENERGY LABEL

A ++



MATERIALES

Acero / Aluminio o Alabastro

ACABADOS

Cuerpo: Negro Mate

Cabeza: Oro envejecido, Antracita, Negro mate

MODIFICACIONES POSIBLES

Cabezal Alabastro (Sobrecoste)

ESPECIFICACIONES

Bombilla GU10 Led (Incluida)
5W - 2700K
220-240 V, 50/60 Hz
IP20, Clase I

BOMBILLA RECOMENDADA

B161

ETIQUETA ENERGÉTICA

A ++

TECHNICAL

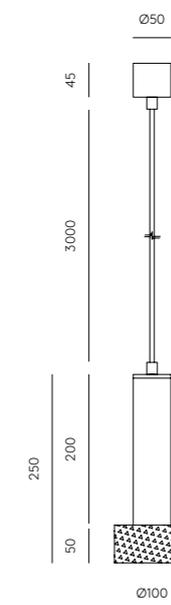

FOCUS

Pendant lamp

C1279/4

Designed by Pepe Fornas, 2020



DESCRIPTION

MATERIALS

Steel / Aluminium or Alabaster

FINISHES

Body: Matt Black
Head: Aged gold, Anthracite, Matt black

POSSIBLE MODIFICATIONS

Alabaster head (Extra charge)

SPECIFICATIONS

Bulb GU10 Led (Included)
4x 5W - 2700K
220-240 V, 50/60 Hz
IP20, Class I

RECOMMENDED BULB

B161

ENERGY LABEL

A ++



MATERIALES

Acero / Aluminio o Alabastro

ACABADOS

Cuerpo: Negro Mate
Cabeza: Oro Viejo / Antracita / Negro mate

MODIFICACIONES POSIBLES

Cabezal Alabastro (Sobrecoste)

ESPECIFICACIONES

Bombilla GU10 Led (Incluida)
4x 5W - 2700K
220-240 V, 50/60 Hz
IP20, Clase I

BOMBILLA RECOMENDADA

B161

ETIQUETA ENERGÉTICA

A ++

TECHNICAL

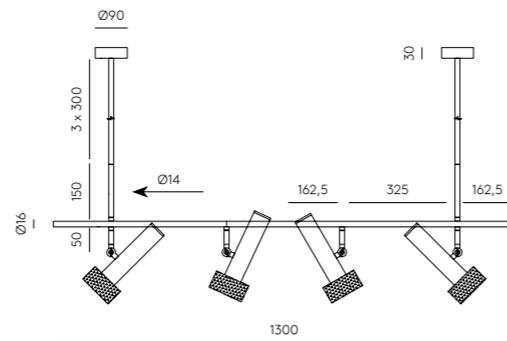

FOCUS

Pendant lamp

C1279/1

Designed by Pepe Fornas, 2019

DESCRIPTION

MATERIALS

Steel / Aluminium or Alabaster

FINISHES

Body: Matt Black
Head: Aged gold, Anthracite, Matt black

POSSIBLE MODIFICATIONS

Alabaster head (Extra charge)

SPECIFICATIONS

Bulb GU10 Led (Included)
5W - 2700K
220-240 V, 50/60 Hz
IP20, Class I

RECOMMENDED BULB

B161

ENERGY LABEL

A ++



MATERIALES

Acero / Aluminio o Alabastro

ACABADOS

Cuerpo: Negro Mate
Cabeza: Oro Viejo / Antracita / Negro mate

MODIFICACIONES POSIBLES

Cabezal Alabastro (Sobrecoste)

ESPECIFICACIONES

Bombilla GU10 Led (Incluida)
5W - 2700K
220-240 V, 50/60 Hz
IP20, Clase I

BOMBILLA RECOMENDADA

B161

ETIQUETA ENERGÉTICA

A ++

TECHNICAL

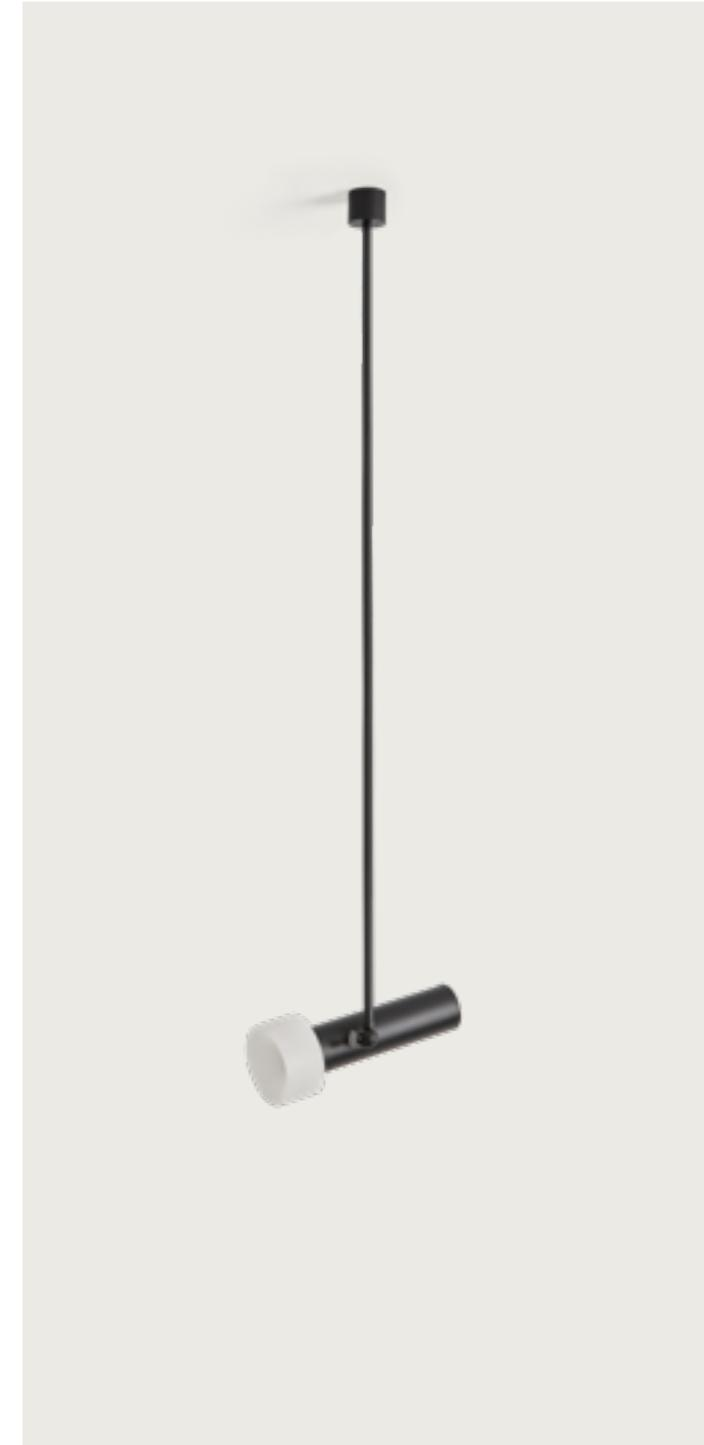
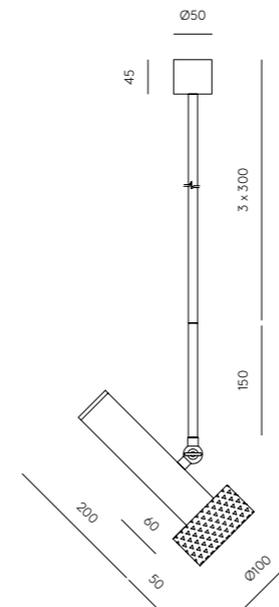

NOOI

C1276

Designed by Pepe Fornas, 2022

DESCRIPTION

MATERIALS

Linen / Steel / Acrylic

FINISHES

Metal:

Matt Black

Shade:

Cream Linen textile

Acrylic:

Opal

SPECIFICATIONS (UE)

T8 5W Dimmable - 3000K

dimmable

220-240V, 50/60Hz

IP20, Class I

ENERGY LABEL

A ++



MATERIALES

Lino / Metal / Acrílico

ACABADOS

Metal:

Negro mate

Tulipa:

Textil Lino Crema

Acrílico:

Opal

ESPECIFICACIONES (UE)

T8 5W Regulable - 3000K

Regulable

220-240 V, 50/60 Hz

IP20, Clase I

ETIQUETA ENERGÉTICA

A ++

TECHNICAL

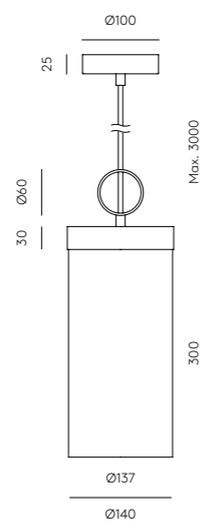

Cairo, Egypt





NINO

Pendant lamp

C1275

Designed by JF Sevilla, 2021

DESCRIPTION

MATERIALS

Steel / Optic Glass

FINISHES

Metal: Matt Black

Details: Matt Brass

Glass: Optic

SPECIFICATIONS

Led Chip x 7W (Included)

2700K TRIAC dimmable

24 V, 50/60 Hz

IP20, Class I

ENERGY LABEL

A ++



MATERIALES

Acero / Vidrio Óptico

ACABADOS

Metal: Negro mate

Detalles: Oro mate

Vidrio: Óptico

ESPECIFICACIONES

Chip Led x 7W (Incluido)

2700K TRIAC regulable

24 V, 50/60 Hz

IP20, Clase I

ETIQUETA ENERGÉTICA

A ++

TECHNICAL

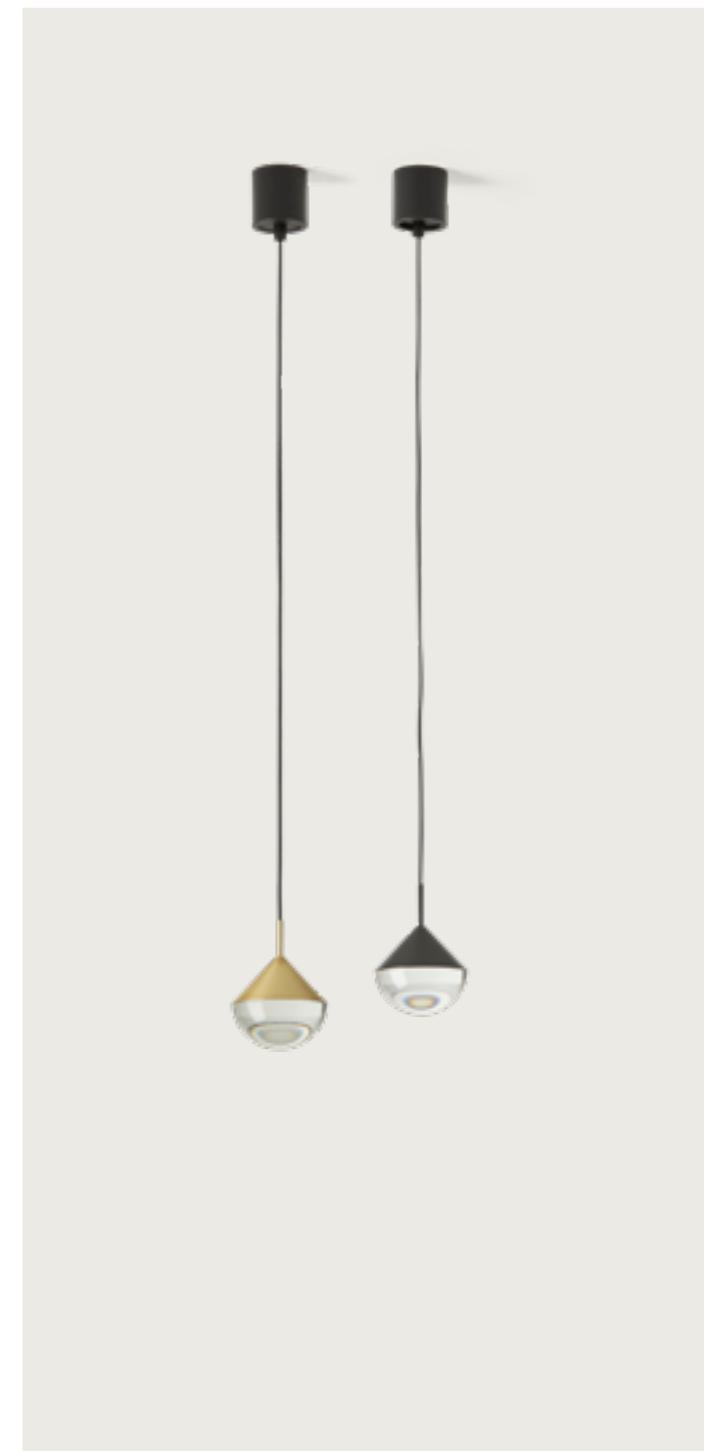
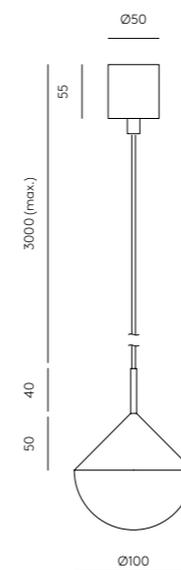

LYB

Pendant lamp

C1274

Designed by Pepe Fornas, 2019



DESCRIPTION

MATERIALS

Steel

FINISHES

Metal:
Matt Black
Matt Brass

SPECIFICATIONS

5 x 5W Integrated Led
3000K
36-50 V, 50/60 Hz
IP20, Class I

ENERGY LABEL

A ++



MATERIALES

Acero

ACABADOS

Metal:
Negro mate
Oro mate

ESPECIFICACIONES

5 x 5W Led integrado
3000K
36-50 V, 50/60 Hz
IP20, Clase I

ETIQUETA ENERGÉTICA

A ++

TECHNICAL

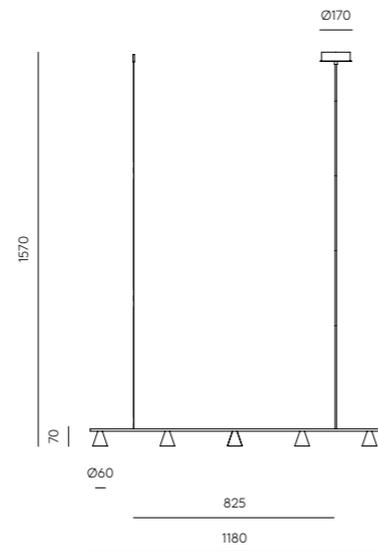

COLN

Pendant lamp

C1267

Designed by AC Studio, 2019

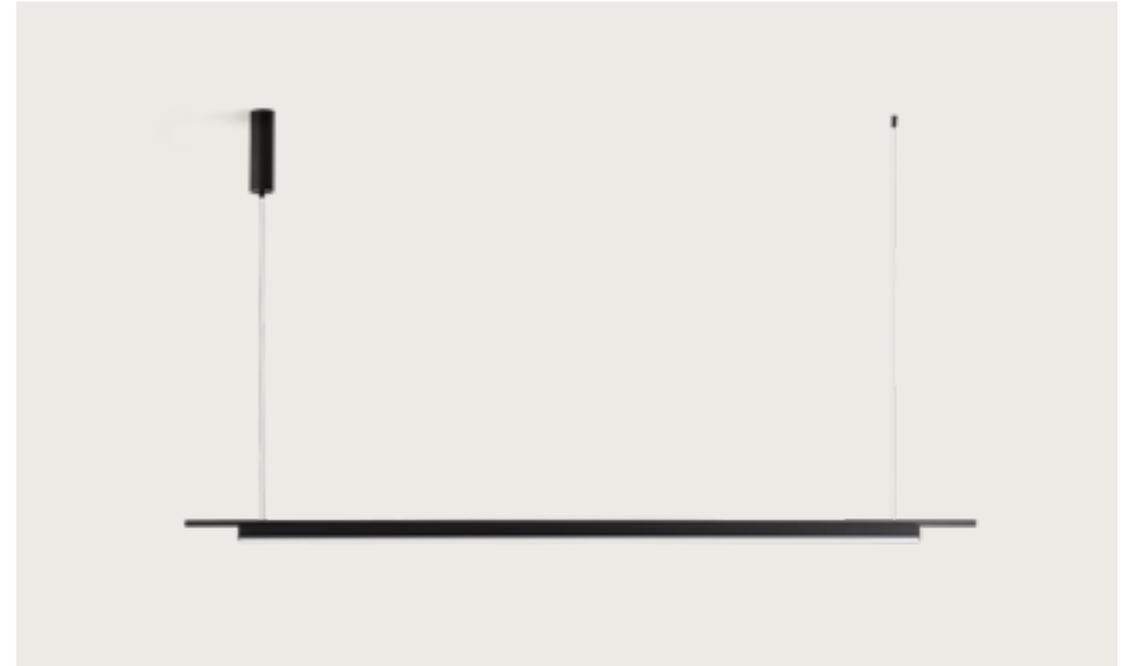

DESCRIPTION

MATERIALS

Steel / Acrylic

FINISHES

Metal:
Matt Black
Diffuser:
White

SPECIFICATIONS

LED strip 21W
2700K TRIAC dimmable
24 V, 50/60 Hz,
IP20, Class I

ASK US FOR DIMMER
OPTIONS PRICE LIST

ENERGY LABEL

A ++



MATERIALES

Acero / Acrílico

ACABADOS

Metal:
Negro mate
Difusor:
Blanco

ESPECIFICACIONES

LED strip 21W
2700K TRIAC dimmable
24 V, 50/60 Hz
IP20, Clase I

CONSULTAR OPCIONES DE
REGULACIÓN EN TARIFA

ETIQUETA ENERGÉTICA

A ++

TECHNICAL

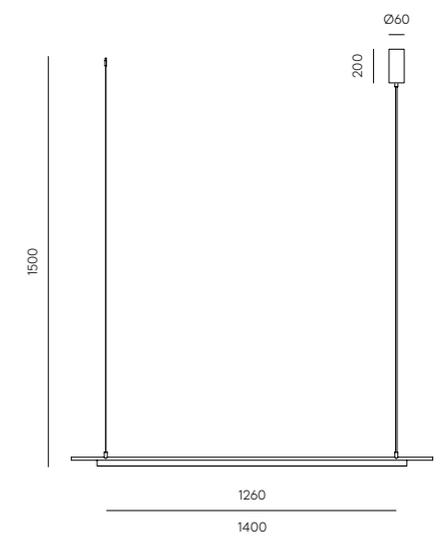

Torino, Italy



GAND

Pendant lamp

C1271

Designed by Pepe Fornas, 2019

DESCRIPTION

MATERIALS

Steel / Blown Glass

FINISHES

Metal:
Matt Black
Chrome
Matt Brass

Glass:
Opal
Clear

SPECIFICATIONS

20 x G4 Led 1,2W - 3000K
Bulbs and shades included
12 V, 50/60 Hz, IP20, Class I

ENERGY LABEL

A ++

⊕ IP20 CE   

MATERIALES

Acero / Cristal Soplado

ACABADOS

Metal:
Negro Mate
Cromo
Oro Mate

Vidrio:
Opal
Transparente

ESPECIFICACIONES

20 x G4 Led 1,2W - 3000K
Bombillas y tulipas incluidas
12 V, 50/60 Hz, IP20, Clase I

ETIQUETA ENERGÉTICA

A ++

TECHNICAL

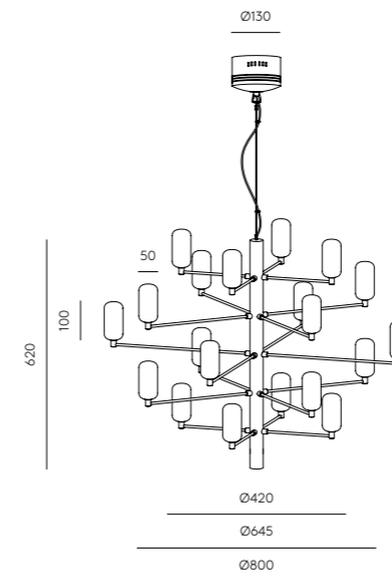

CLIP

Pendant lamp

C1265

Designed by Pepe Fornas, 2018

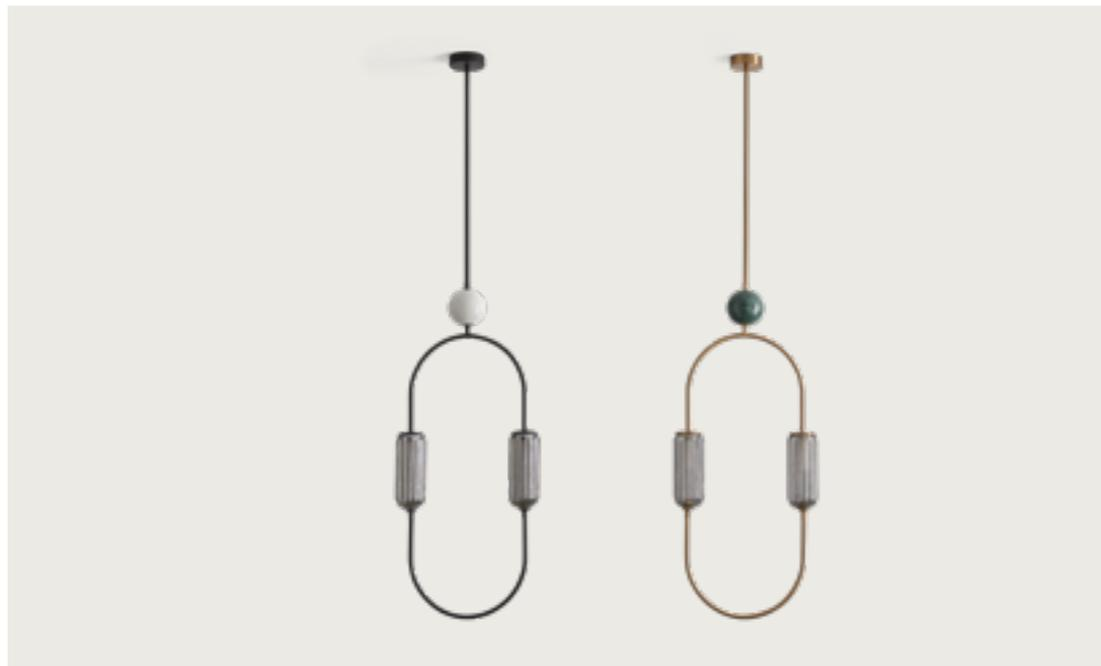

DESCRIPTION

MATERIALS

Steel / Marble / Blown Glass

FINISHES

Metal:
Matt Black
Aged Gold

Marble:
White
Green

Glass:
Smoked

SPECIFICATIONS

Bulb 2 x G9 Led (Included)
2 x 5W - 2700K
220-240 V, 50/60 Hz
IP20, Class I

RECOMMENDED BULB

B005/5W

ENERGY LABEL

A ++

⊕ IP20 CE

TECHNICAL

MATERIALES

Acero / Mármol / Vidrio Soplado

ACABADOS

Metal:
Negro Mate
Oro Envejecido

Mármol:
Blanco
Verde

Vidrio:
Fumé

ESPECIFICACIONES

Bombilla 2 x G9 Led (Incluida)
2 x 5W - 2700K
220-240 V, 50/60 Hz
IP20, Clase I

BOMBILLA RECOMENDADA

B005/5W

ETIQUETA ENERGÉTICA

A ++

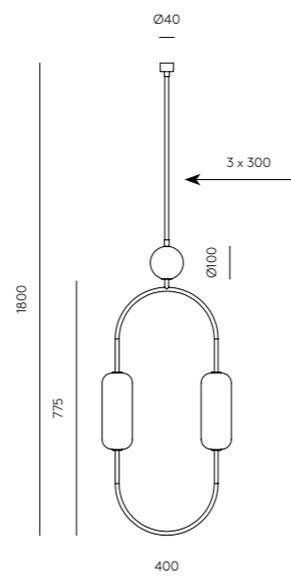



TERA

Pendant lamp

C1260

Designed by AC Studio, 2022

DESCRIPTION

MATERIALS

Steel

FINISHES

Metal:

Matt Brass

Matt black

Blued

SPECIFICATIONS

LED chip 8W - 3000K

Dimmable: TRIAC - DALI/PUSH

220-240V - 24V - 50/60Hz

IP20 - Class I

ENERGY LABEL

A ++

⊕ IP20 CE   

MATERIALES

Acero

ACABADOS

Metal:

Negro mate

Latón mate

Pavonado

ESPECIFICACIONES

Chip LED 8W - 3000K

Regulable: TRIAC - DALI/PUSH

220-240V - 24V - 50/60 Hz

IP20 - Clase I

ETIQUETA ENERGÉTICA

A ++

TECHNICAL

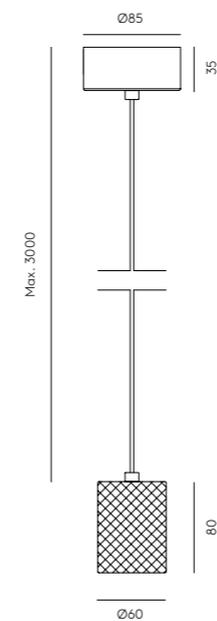

ABBACUS

Pendant lamp

C1258

Designed by Pepe Fornas, 2018

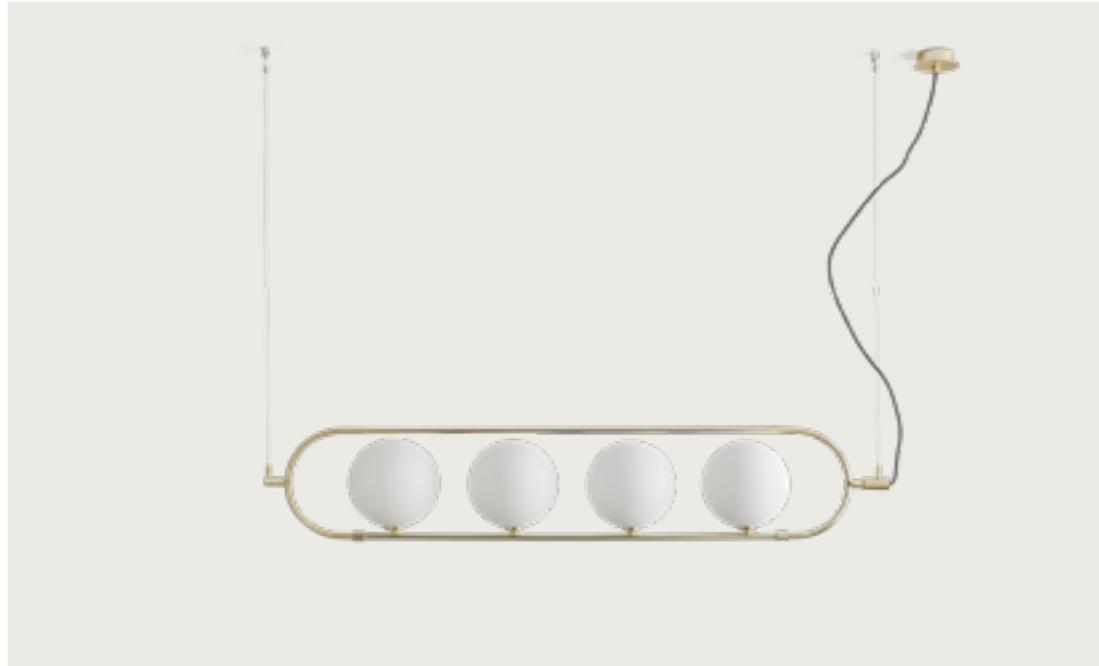

DESCRIPTION

MATERIALS
Steel / Glass

FINISHES

Metal:
Matt Black
Matt Brass

Glass:
Opal
Clear

SPECIFICATIONS

Bulb G9 Led (Included)
4 x 5W - 2700K
220-240 V, 50/60 Hz
IP20, Class I

RECOMMENDED BULB
B005/5W

ENERGY LABEL
A ++



MATERIALES
Acero / Vidrio

ACABADOS

Metal:
Negro Mate
Oro Mate

Vidrio:
Opal
Transparente

ESPECIFICACIONES

Bombilla G9 Led (Incluida)
4 x 5W - 2700K
220-240 V, 50/60 Hz
IP20, Clase I

BOMBILLA RECOMENDADA
B005/5W

ETIQUETA ENERGÉTICA
A ++

TECHNICAL

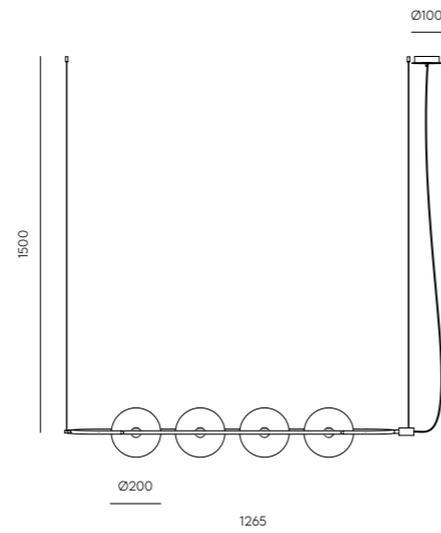

ABBACUS

Pendant lamp

C1258/1

Designed by Pepe Fornas, 2018

DESCRIPTION

MATERIALS
Steel / Glass

FINISHES

Metal:
Matt Black
Matt Brass

Glass:
Opal
Clear

SPECIFICATIONS

Bulb G9 Led (Included)
1 x 5W - 2700K
220-240 V, 50/60 Hz
IP20, Class I

RECOMMENDED BULB
B005/5W

ENERGY LABEL
A ++



MATERIALES
Acero / Vidrio

ACABADOS

Metal:
Negro Mate
Oro Mate

Vidrio:
Opal
Transparente

ESPECIFICACIONES

Bombilla G9 Led (Incluida)
1 x 5W - 2700K
220-240 V, 50/60 Hz
IP20, Clase I

BOMBILLA RECOMENDADA
B005/5W

ETIQUETA ENERGÉTICA
A ++

TECHNICAL

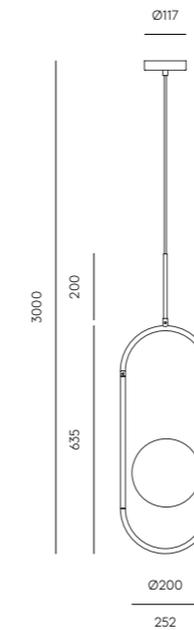

ERTO

C1257/5

Designed by Pepe Fornas, 2020

DESCRIPTION

MATERIALS

Steel

FINISHES

Metal:
Matt Black

Details:
Matt Brass

COMPATIBLE ACCESSORIES (INCLUDED)

Alabaster: 1096/25
Glass: 1223
Ceramic: 1097/20
Metal: 1038/25
Stripped Metal 1089/25

SPECIFICATIONS

5 x G9 LED 5W 2700K (Included)
220-240 V, 50/60 Hz
IP20, Class I

RECOMMENDED BULB

B005/5W

ENERGY LABEL

A ++

⊕ IP20 CE   

MATERIALES

Acero

ACABADOS

Metal:
Negro Mate

Detalles:
Oro Mate

ACCESORIOS COMPATIBLES (INCLUIDO)

Alabastro: 1096/25
Vidrio: 1223
Cerámica: 1097/20
Metal: 1038/25
Varillas Metal 1089/25

ESPECIFICACIONES

5 x G9 LED 5W 2700K (Incluidas)
220-240 V, 50/60 Hz
IP20, Clase I

BOMBILLA RECOMENDADA

B005/5W

ETIQUETA ENERGÉTICA

A ++

TECHNICAL

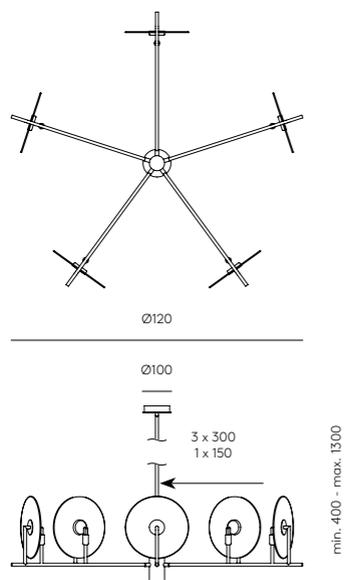

Madrid, Spain



FRAME

Pendant lamp

C1246

Designed by AC Studio, 2018

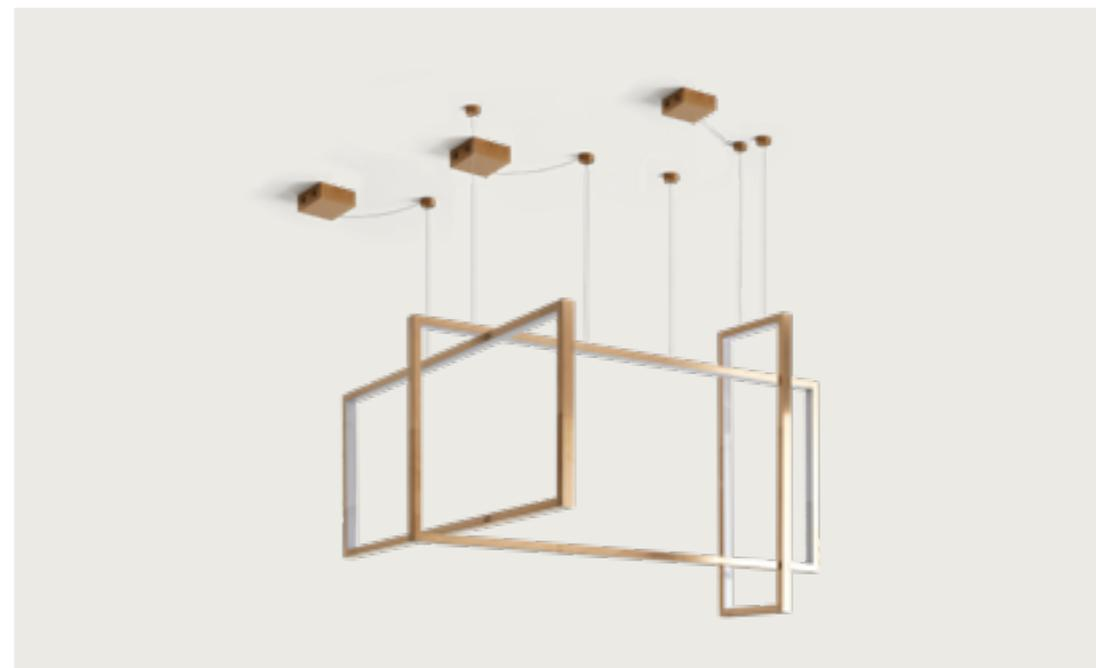

DESCRIPTION

MATERIALS

Steel

FINISHES

Metal:
Bronze
Matt Black

SIZES

1400 x 600 - 36W Led 3000K
1200 x 500 - 30W Led 3000K
900 x 300 - 22W Led 3000K

SPECIFICATIONS

24 V, 50/60 Hz, IP20, Class I

**ASK US FOR DIMMER
OPTIONS PRICE LIST**

RECOMMENDED BULB
B005/5W

SOLD INDIVIDUALLY

ENERGY LABEL
A ++



MATERIALES

Acero

ACABADOS

Metal:
Bronze
Negro Mate

ACABADOS

1400 x 600 - 36W Led 3000K
1200 x 500 - 30W Led 3000K
900 x 300 - 22W Led 3000K

ESPECIFICACIONES

24 V, 50/60 Hz, IP20, Clase I

**CONSULTAR OPCIONES DE
REGULACIÓN EN TARIFA**

BOMBILLA RECOMENDADA
B005/5W

SE VENDEN POR SEPARADO

ETIQUETA ENERGÉTICA
A ++

TECHNICAL

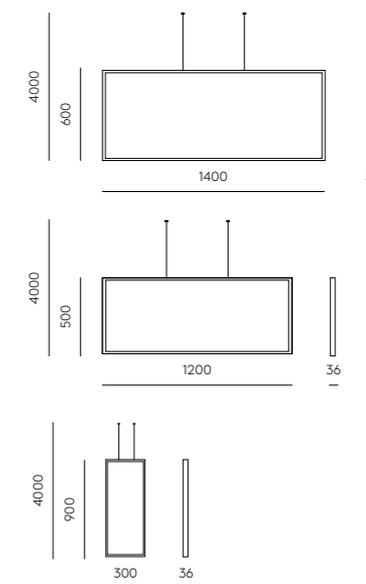

MAHO

Pendant lamp

C1254/6

Designed by JF Sevilla, 2021

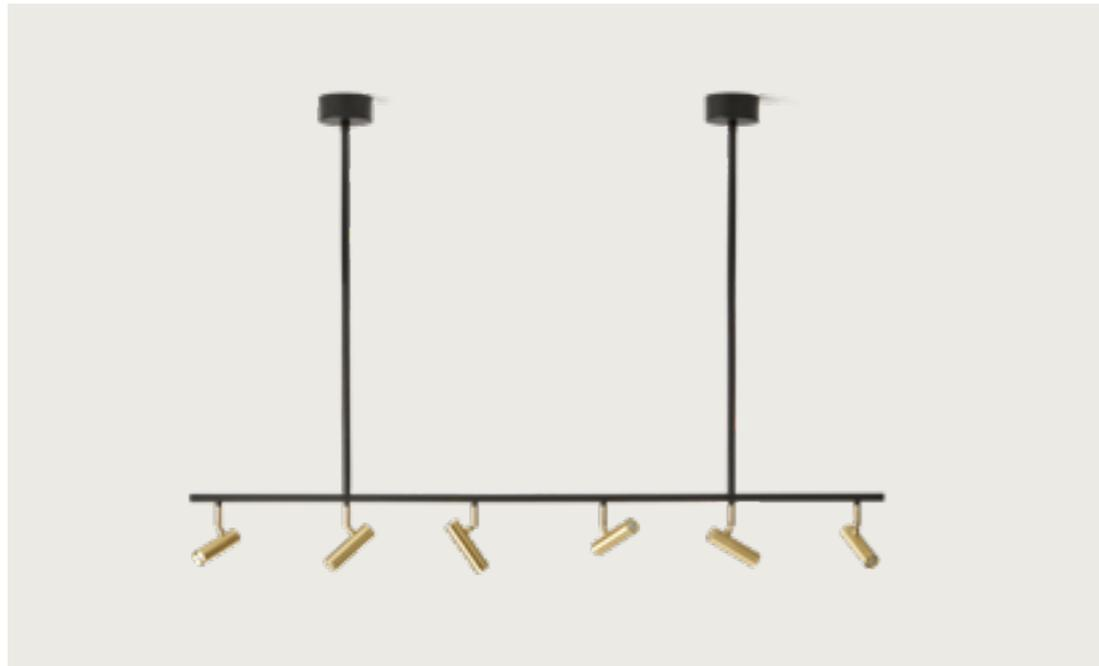

DESCRIPTION

MATERIALS

Steel

FINISHES

Metal:
Matt Black

Heads:
Matt Brass

SPECIFICATIONS

Integrated Led Cob 6x5W
(Incluido)
3000K TRIAC Dimmable
230 V, 50/60 Hz
IP20, Class I

ENERGY LABEL

A ++



MATERIALES

Acero

ACABADOS

Metal:
Negro Mate

Cabezales:
Oro Mate

ESPECIFICACIONES

Led Cob integrado 6x5W
(Incluido)
3000K TRIAC Regulable
230 V, 50/60 Hz
IP20, Clase I

ETIQUETA ENERGÉTICA

A ++

TECHNICAL

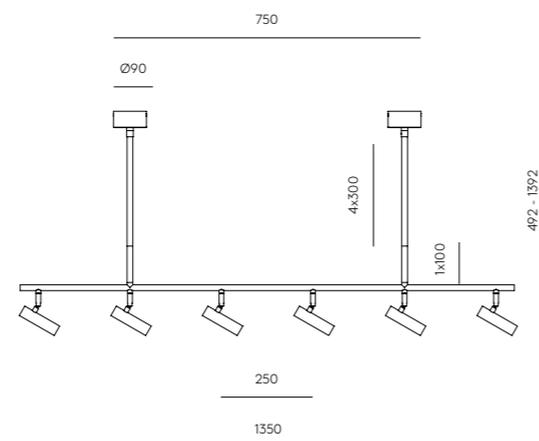

OHLALA

Pendant lamp

C1242

Designed by AC Studio, 2018

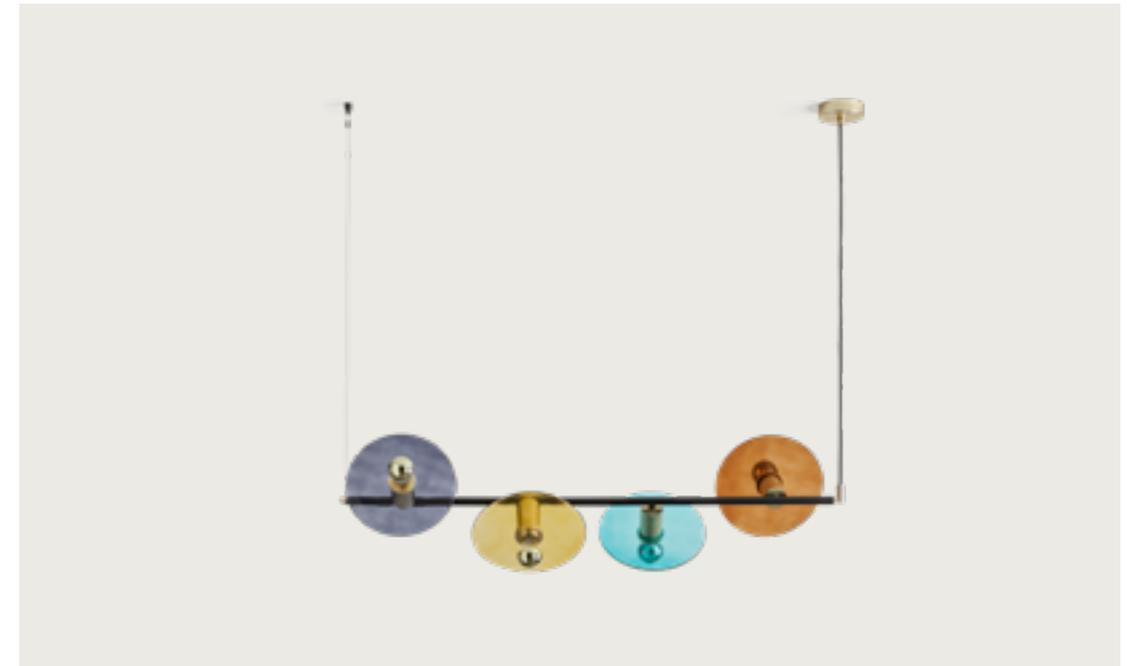

DESCRIPTION

MATERIALS

Steel

FINISHES

Metal:
Matt Black

Lampholders:
Matt Brass

IMAGE COMPOSITION

Accessory 1223/25
Bulb B038/GOLD
(Not included)

SPECIFICATIONS

4 x E27 Max. 60W (Not included)
220-240 V, 50/60 Hz
IP20, Class I

COMPATIBLE ACCESSORIES

Ø Max. 25cm
More options in page

ENERGY LABEL

A ++



MATERIALES

Acero

ACABADOS

Metal:
Negro Mate

Portalámparas:
Oro Mate

COMPOSICION IMAGEN

Accesorio 1223/25
Bombilla B038/ORO
(No incluidos)

ESPECIFICACIONES

4 x E27 Max. 60W (No incluida)
220-240 V, 50/60 Hz
IP20, Clase I

ACCESORIOS COMPATIBLES

Ø Máx 25cm
Más opciones en pág.

ETIQUETA ENERGÉTICA

A ++

TECHNICAL

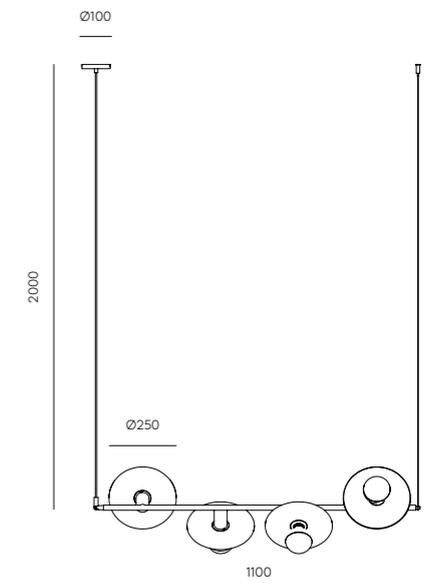

CRANE

Pendant lamp

C1241

Designed by JF Sevilla, 2017



DESCRIPTION

MATERIALS

Steel / Blown Glass

FINISHES

Metal:
Matt Black
Matt Brass

Glass:
Opal

SPECIFICATIONS

E27 Max. 60W (Not included)
G4 2 x 3W - 2700K (Included)
220-240 V, 50/60 Hz
IP20, Class I

RECOMMENDED BULB

B211 (7, 9, 11W) E27

ENERGY LABEL

A ++



MATERIALES

Acero / Vidrio Soplado

ACABADOS

Metal:
Negro Mate
Oro Mate

Vidrio:
Opal

ESPECIFICACIONES

E27 Max. 60W (No incluida)
G4 2 x 3W - 2700K (Incluidas)
220-240 V, 50/60 Hz
IP20, Clase I

BOMBILLA RECOMENDADA

B211 (7, 9, 11W) E27

ETIQUETA ENERGÉTICA

A ++

TECHNICAL

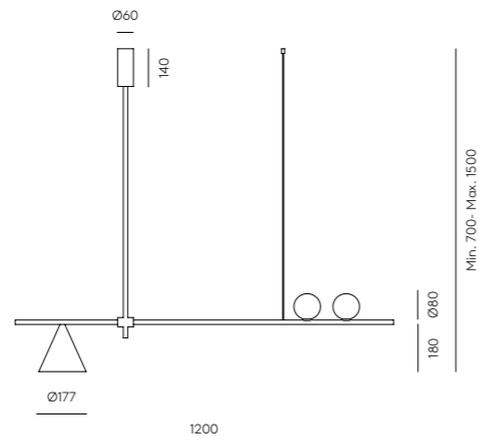

LUCA

Pendant lamp

C1238

Designed by AC Studio, 2017

DESCRIPTION

MATERIALS

Steel / Acrylic

FINISHES

Metal:
Matt Black

Acrylic:
Clear

SPECIFICATIONS

E27 Max. 60W (Not included)
220-240 V, 50/60 Hz
IP20, Class I

RECOMMENDED BULB

B211 (7, 9, 11W)

ENERGY LABEL

A ++



MATERIALES

Acero / Acrílico

ACABADOS

Metal:
Negro Mate

Acrílico:
Transparente

ESPECIFICACIONES

E27 Max. 60W (No incluida)
220-240 V, 50/60 Hz
IP20, Clase I

BOMBILLA RECOMENDADA

B211 (7, 9, 11W)

ETIQUETA ENERGÉTICA

A ++

TECHNICAL

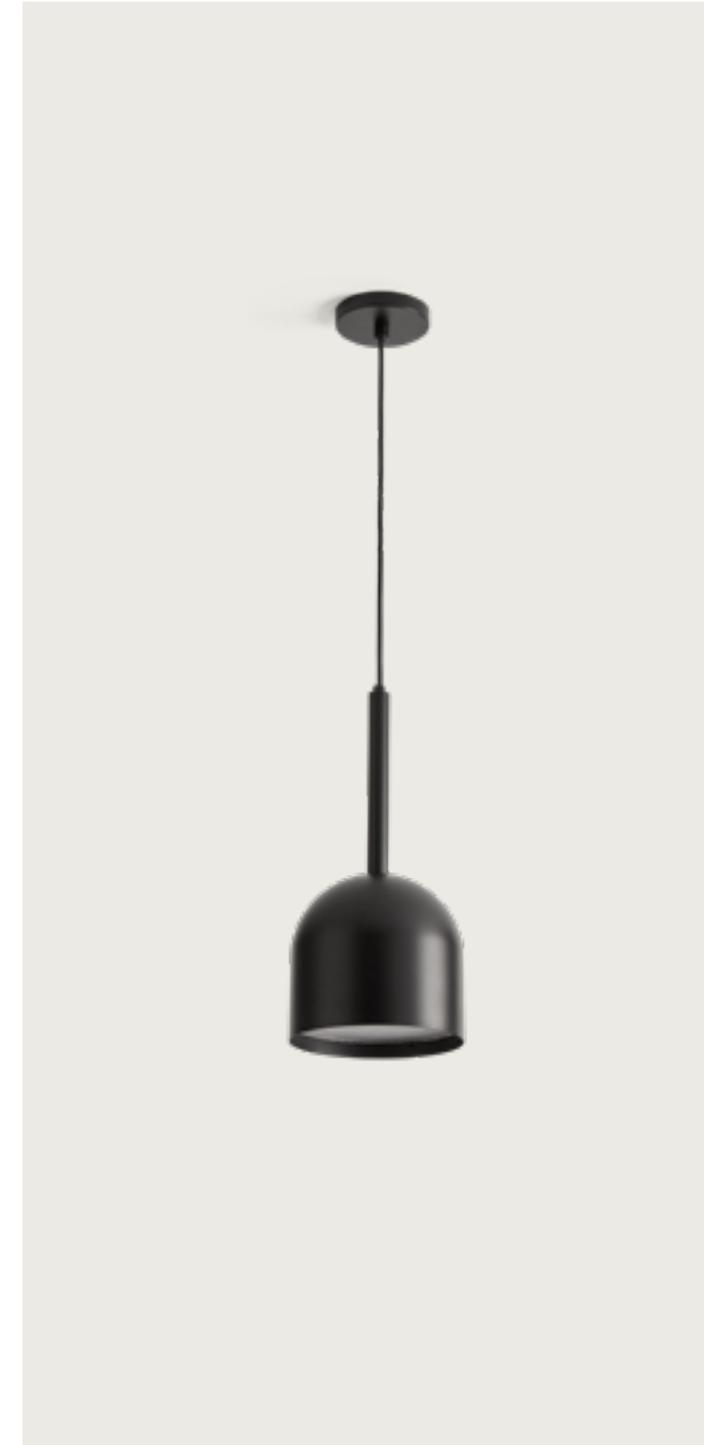
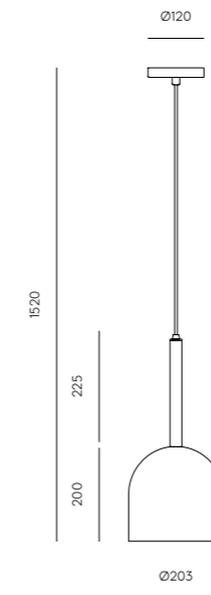

LUCA +

C1239/3

Designed by AC Studio, 2017

DESCRIPTION

MATERIALS

Steel

FINISHES

Metal:
Matt Black

SPECIFICATIONS

3x E27 Max. 60W (Not included)
220-240 V, 50/60 Hz
IP20, Class I

RECOMMENDED BULB

B211 (7, 9, 11W)

ENERGY LABEL

A ++

⊕ IP20 CE   

MATERIALES

Acero

ACABADOS

Metal:
Negro Mate

ESPECIFICACIONES

3x E27 Max. 60W (No incluida)
220-240 V, 50/60 Hz
IP20, Clase I

BOMBILLA RECOMENDADA

B211 (7, 9, 11W)

ETIQUETA ENERGÉTICA

A ++

TECHNICAL

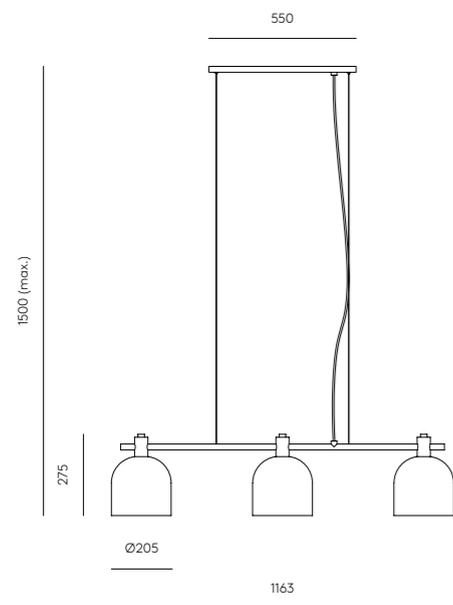



LOTA

C1235

Designed by Pepe Fornas, 2021

DESCRIPTION

MATERIALS

Steel / Blown Glass

FINISHES

Metal:

Matt Black

Glass Shade:

Clear

SPECIFICATIONS

Integrated 9W LED, 3000K

TRIAC Dimmable

24V, 50/60 HZ

IP20, CLASE I

ENERGY LABEL

A ++

⊕ IP20 CE    

MATERIALES

Acero / Vidrio Soplado

ACABADOS

Metal:

Negro Mate

Tulipa Vidrio:

Transparente

ESPECIFICACIONES

Placa LED 9W integrada 3000K

TRIAC Regulable

24V, 50/60 Hz

IP20, Clase I

ETIQUETA ENERGÉTICA

A ++

TECHNICAL

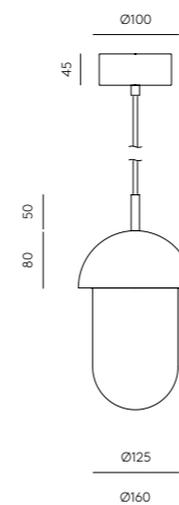

LITA

Pendant lamp

C1230

Designed by Pepe Fornas, 2020

DESCRIPTION

MATERIALS

Steel / Wood

FINISHES

Metal:
Matt Black

Wood:
Black

SPECIFICATIONS

Integrated Led Cob
3W 3000K (Included)
12V / 220-240 V, 50/60 Hz

ENERGY LABEL

A ++

MATERIALES

Acero / Madera

ACABADOS

Metal:
Negro Mate

Madera:
Negro

ESPECIFICACIONES

Cob Led Integrado
3W 3000K (Incluida)
12V / 220-240 V, 50/60 Hz

ETIQUETA ENERGÉTICA

A ++

⊕ IP20 CE   

TECHNICAL

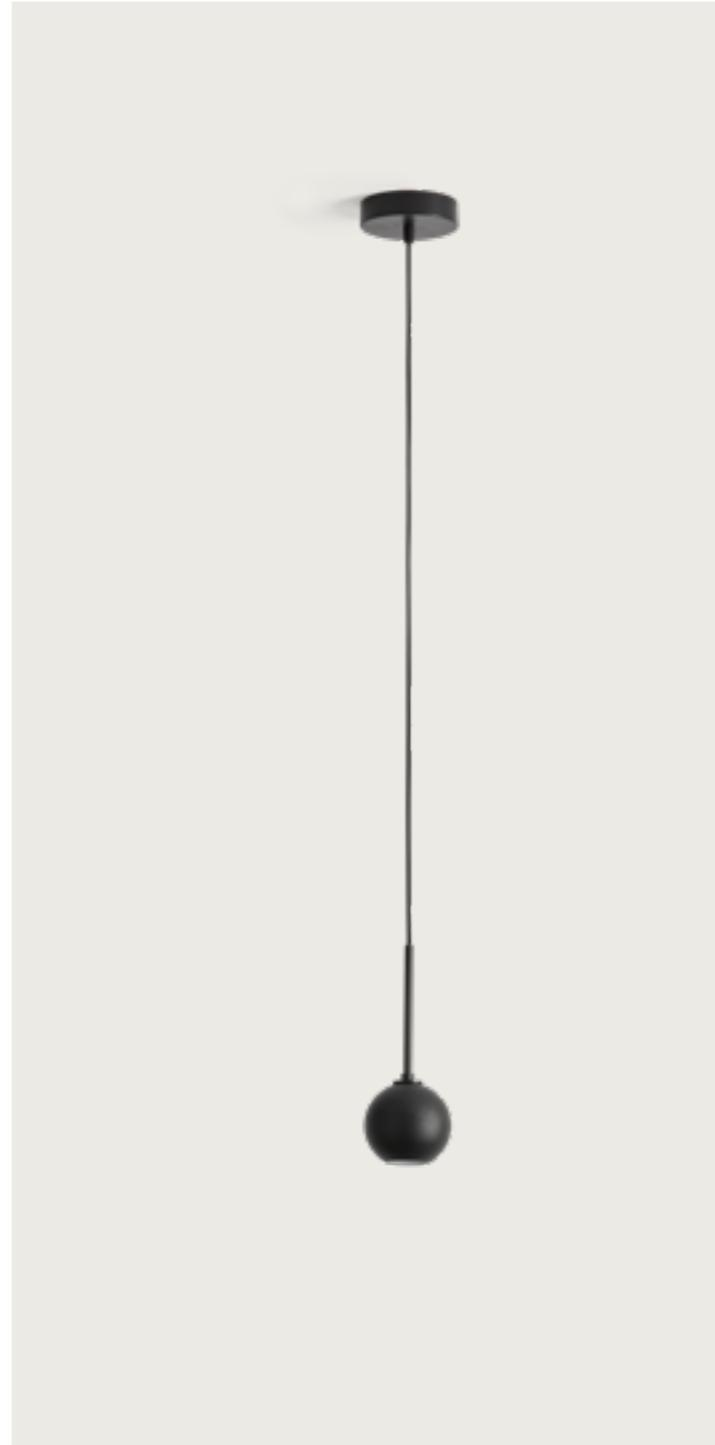
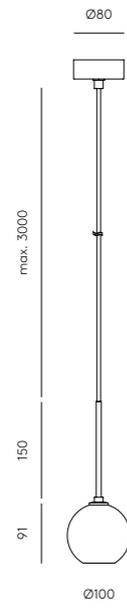

LITA

Pendant lamp

C1230 /4

Designed by Pepe Fornas, 2020

DESCRIPTION

MATERIALS

Steel / Wood

FINISHES

Metal:
Matt Black

Wood:
Walnut
Black

SPECIFICATIONS

4 x Integrated Led Cob
3W 3000K (Included)
12V / 220-240 V, 50/60 Hz

ENERGY LABEL

A ++

MATERIALES

Acero / Madera

ACABADOS

Metal:
Negro Mate

Madera:
Nogal
Negro

ESPECIFICACIONES

4 x Cob Led Integrado
3W 3000K (Incluida)
12V / 220-240 V, 50/60 Hz

ETIQUETA ENERGÉTICA

A ++

⊕ IP20 CE   

DESCRIPTION

MATERIALS

Steel / Wood

FINISHES

Metal:
Matt Black

Wood:
Walnut
Black

SPECIFICATIONS

4 x Integrated Led Cob
3W 3000K (Included)
12V / 220-240 V, 50/60 Hz

ENERGY LABEL

A ++

TECHNICAL

MATERIALES

Acero / Madera

ACABADOS

Metal:
Negro Mate

Madera:
Nogal
Negro

ESPECIFICACIONES

4 x Cob Led Integrado
3W 3000K (Incluida)
12V / 220-240 V, 50/60 Hz

ETIQUETA ENERGÉTICA

A ++

⊕ IP20 CE   

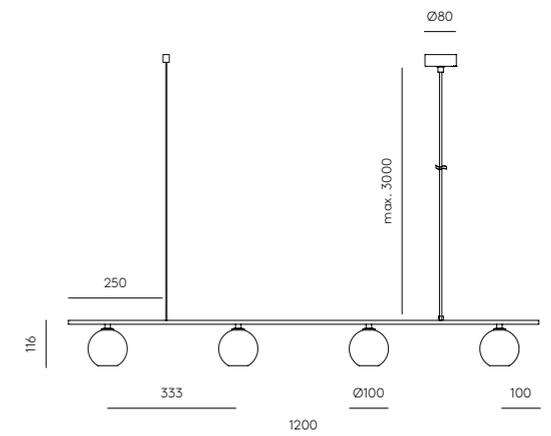

NERA SIX

Pendant lamp

C1229/6

Designed by AC Studio, 2021



DESCRIPTION

MATERIALS

Steel / Acrylic

FINISHES

Metal:
Matt Black

Heads:
Matt Black

SPECIFICATIONS

Integrated Led Cob 6x8W
(incluido)
3000K, 230V - 24V, 50/60 Hz
IP20, Class I

ENERGY LABEL

A ++



MATERIALES

Acero / Acrílico

ACABADOS

Metal:
Negro Mate

Cabezales:
Negro Mate

ESPECIFICACIONES

Led Cob integrado 6x8W
(incluido)
3000K, 230V - 24V, 50/60 Hz
IP20, Clase I

ETIQUETA ENERGÉTICA

A ++

TECHNICAL

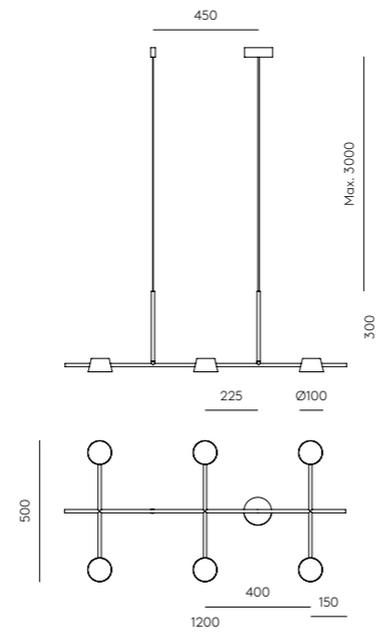

NERA

Pendant lamp

C1229

Designed by Pepe Fornas, 2020

DESCRIPTION

MATERIALS

Steel / Acrylic

FINISHES

Metal:
Matt Black

Head:
Matt Black

SPECIFICATIONS

Integrated Led Cob 8W
(incluido)
3000K, 230V - 24V, 50/60 Hz
IP20, Class I

ENERGY LABEL

A ++



MATERIALES

Acero / Acrílico

ACABADOS

Metal:
Negro Mate

Cabezal:
Negro Mate

ESPECIFICACIONES

Led Cob integrado 8W
(incluido)
3000K, 230V - 24V, 50/60 Hz
IP20, Clase I

ETIQUETA ENERGÉTICA

A ++

TECHNICAL

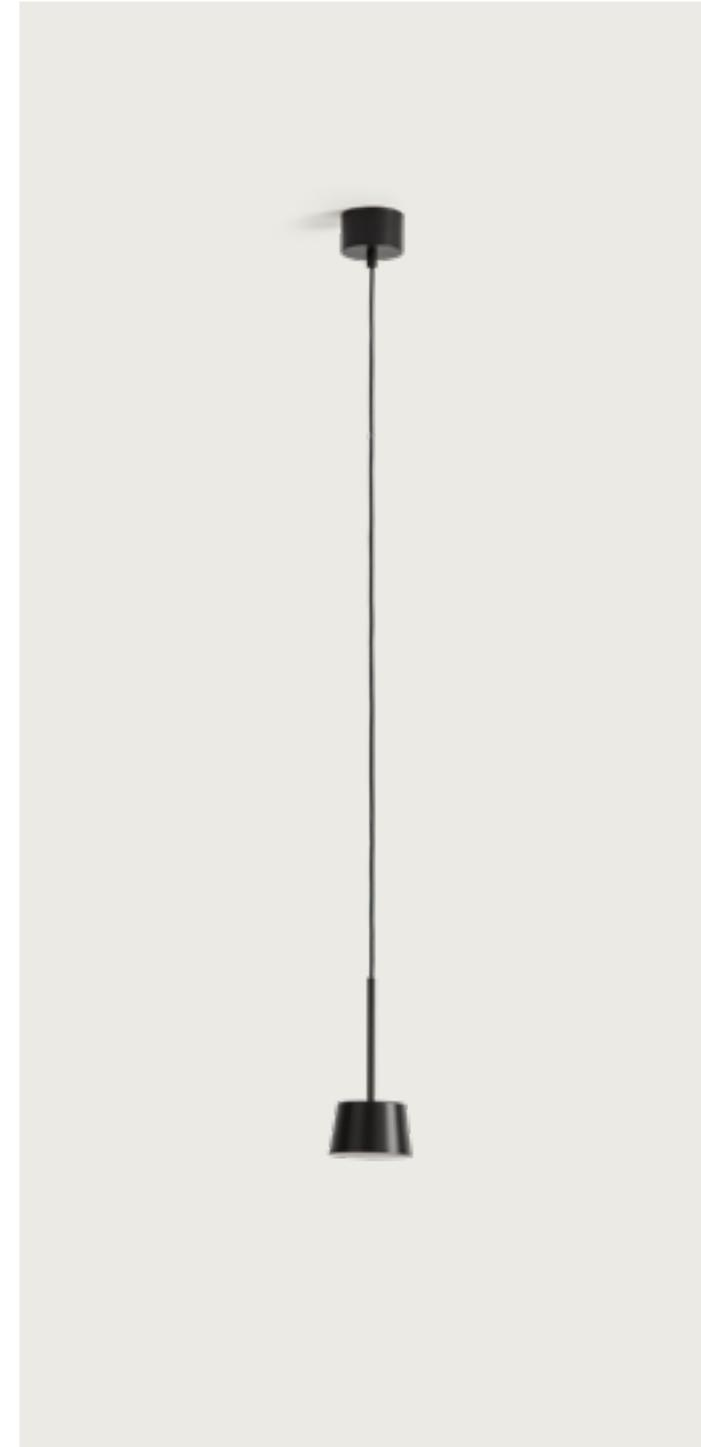
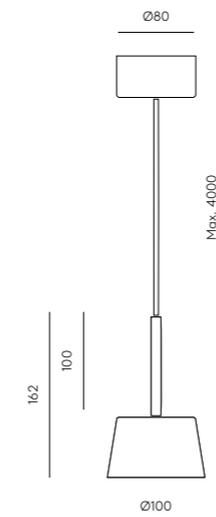



DORA

Pendant lamp

C1228

Designed by Jana Chang, 2016

DESCRIPTION

MATERIALS

Steel / Optic Glass

FINISHES

Metal:

Shiny Gold

Canopy / Cable:

Matt Black

OPTIONS

B033 (Standard) Opal

B034/Cob Clear

SPECIFICATIONS

Integrated Led

6,5W - 3000K

12 V, 50/60 Hz

IP20, Class I

ENERGY LABEL

A ++

MATERIALES

Acero / Cristal Óptico

ACABADOS

Metal:

Oro brillo

Florón / Cable:

Negro Mate

OPCIONES

B033 (Estándar) Opal

B034/Cob Transparente

ESPECIFICACIONES

Led integrado

6,5W - 3000K

12 V, 50/60 Hz

IP20, Clase I

ETIQUETA ENERGÉTICA

A ++

⊕ IP20 CE     

TECHNICAL

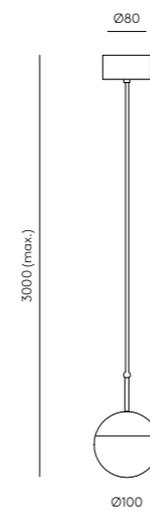

ALOA

Pendant lamp

C1227

Designed by Fornasevi, 2016

DESCRIPTION

MATERIALS

Steel

FINISHES

Metal:
Matt Black

Diffuser:
Shiny Gold

RECOMMENDED BULB

B038/GOLD

SPECIFICATIONS

E27 Max. 60W
(Not included)
220-240 V, 50/60 Hz
IP20, Class I

ENERGY LABEL

A ++

⊕ IP20 CE   

MATERIALES

Acero

ACABADOS

Metal:
Negro Mate

Difusor:
Oro Brillo

BOMBILLA RECOMENDADA

B038/ORO

ESPECIFICACIONES

E27 Max. 60W
(No incluida)
220-240 V, 50/60 Hz
IP20, Clase I

ETIQUETA ENERGÉTICA

A ++

TECHNICAL

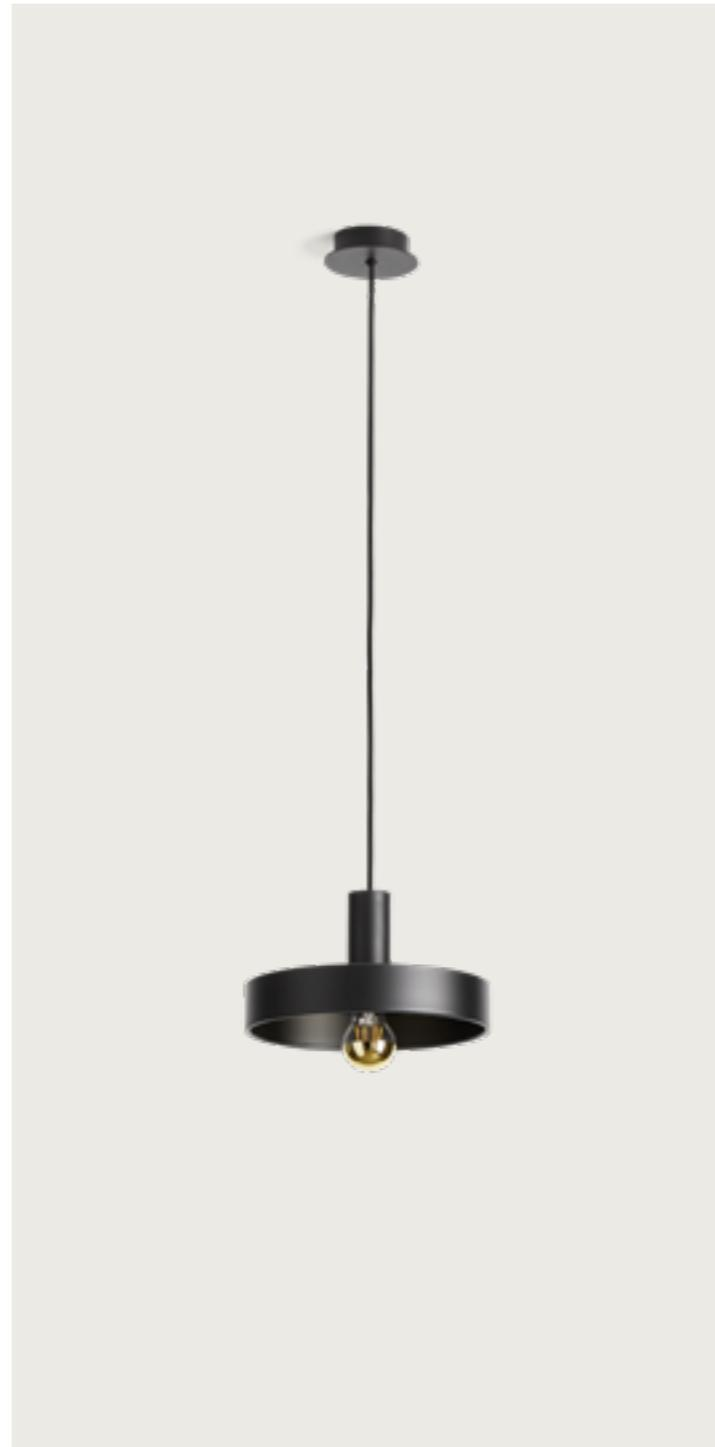
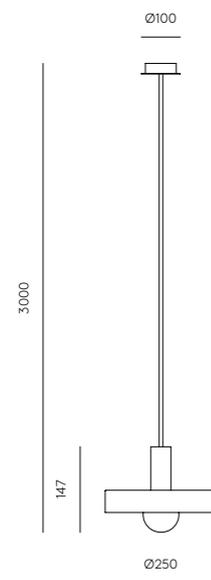

ALOA

Pendant lamp

C1227/4

Designed by Fornasevi, 2016

DESCRIPTION

MATERIALS

Steel

FINISHES

Metal:
Matt Black

Diffuser:
Shiny Gold

RECOMMENDED BULB

B038/GOLD

SPECIFICATIONS

4 x E27 Max. 60W
(Not included)
220-240 V, 50/60 Hz
IP20, Class I

ENERGY LABEL

A ++

⊕ IP20 CE   



DESCRIPTION

MATERIALS

Steel

FINISHES

Metal:
Matt Black

Diffuser:
Shiny Gold

RECOMMENDED BULB

B038/GOLD

SPECIFICATIONS

4 x E27 Max. 60W
(Not included)
220-240 V, 50/60 Hz
IP20, Class I

ENERGY LABEL

A ++

⊕ IP20 CE   

MATERIALES

Acero

ACABADOS

Metal:
Negro Mate

Difusor:
Oro Brillo

BOMBILLA RECOMENDADA

B038/ORO

ESPECIFICACIONES

4 x E27 Max. 60W
(No incluida)
220-240 V, 50/60 Hz
IP20, Clase I

ETIQUETA ENERGÉTICA

A ++

TECHNICAL

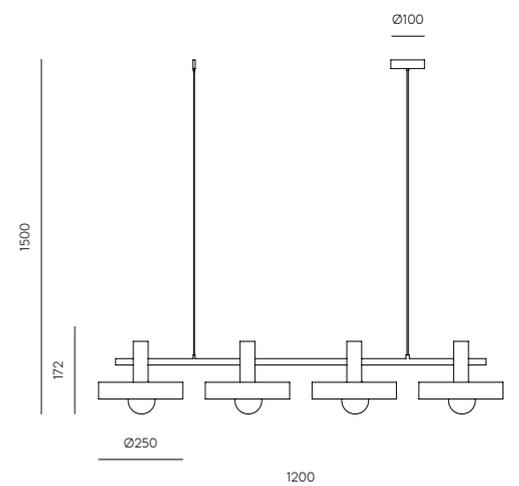

DELIE

Pendant lamp

C1224

Designed by JF Sevilla, 2020

DESCRIPTION

MATERIALS

Steel / Blown Glass / Marble

FINISHES

Metal: Matt Black
Marble: White
Aged Gold Black

Glass: Opal

RECOMMENDED BULB

B005/5W

SPECIFICATIONS

G9 LED Bulbs (Included)
5W 2700K, 220-240 V,
50/60 Hz, IP20, Class I

ENERGY LABEL

A ++



MATERIALES

Acero / Vidrio Soplado / Mármol

ACABADOS

Metal: Negro Mate
Mármol: Blanco
Oro Envejecido Negro

Cristal: Opal

BOMBILLA RECOMENDADA

B005/5W

ESPECIFICACIONES

Bombillas G9 LED (Incluidas)
5W 2700K, 220-240 V,
50/60 Hz, IP20, Clase I

ETIQUETA ENERGÉTICA

A ++



TECHNICAL

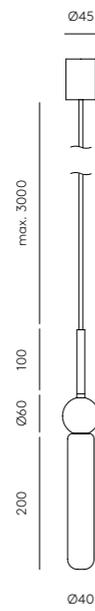

DELIE

Pendant lamp

C1224/8

Designed by JF Sevilla, 2020



DESCRIPTION

MATERIALS

Steel / Blown Glass / Marble

FINISHES

Metal: Matt Black
Marble: White
Aged Gold Black

Glass: Opal

RECOMMENDED BULB

B005/5W

SPECIFICATIONS

8 x G9 LED Bulbs (Included)
5W 2700K, 220-240 V,
50/60 Hz, IP20, Class I

ENERGY LABEL

A ++

MATERIALES

Acero / Vidrio Soplado / Mármol

ACABADOS

Metal: Negro Mate
Mármol: Blanco
Oro Envejecido Negro

Cristal: Opal

BOMBILLA RECOMENDADA

B005/5W

ESPECIFICACIONES

8 x Bombillas G9 LED (Incluidas)
5W 2700K, 220-240 V,
50/60 Hz, IP20, Clase I

ETIQUETA ENERGÉTICA

A ++

TECHNICAL

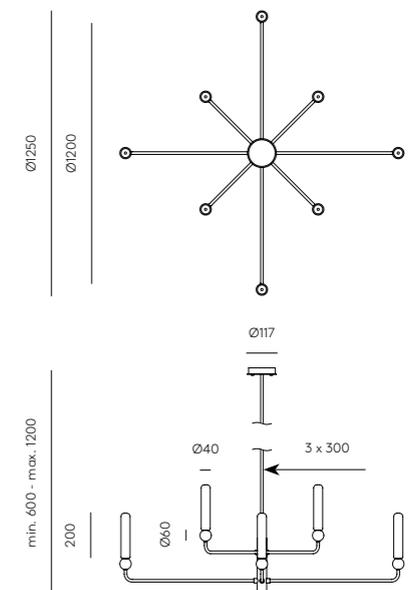

FEST

Pendant lamp

C1223

Designed by JF Sevilla, 2016



DESCRIPTION

MATERIALS

Steel / Glass / Fabric Cable

FINISHES

Metal:
Matt Black
Cable:
Black
Copper

COLOR GLASS (INCLUDED)

Turquoise, amber, pink,
dark blue & brown.
More options on page.

RECOMMENDED BULB

B038/GOLD

SPECIFICATIONS

6 x E27 Max. 60W (Not included)
220-240 V, 50/60 Hz, IP20,
Class I

ENERGY LABEL

A ++



MATERIALES

Acero / Vidrio / Cable textil

ACABADOS

Metal:
Negro Mate
Cable:
Negro
Cobre

COLOR CRISTAL (INCLUIDOS)

Turquesa, ámbar, rosa,
azul oscuro y marrón.
Más opciones en pág.362.

BOMBILLA RECOMENDADA

B038/ORO

ESPECIFICACIONES

6 x E27 Max. 60W (No incluida)
220-240 V, 50/60 Hz, IP20,
Clase I

ETIQUETA ENERGÉTICA

A ++

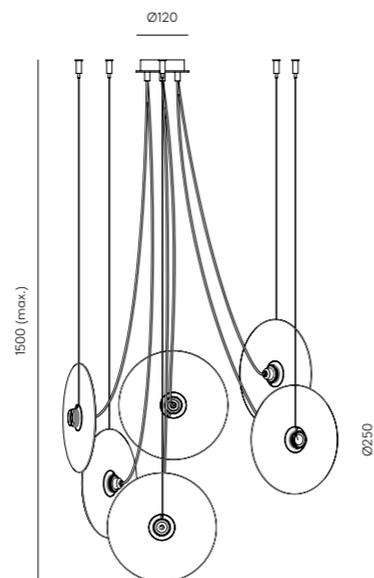

HELMET

Pendant lamp

C1221

Designed by Pepe Fornas, 2016

DESCRIPTION

MATERIALS

Steel / Blown Glass

FINISHES

Metal:
Shiny Gold / Matt Brass / Matt
Black / Chrome

BULB INCLUDED

B034/COB
B033/COB

SPECIFICATIONS

E27-B033/COB (opal) included
3W - 3000K, 220-240 V,
50/60 Hz, IP20, Class I

ENERGY LABEL

A ++



MATERIALES

Acero / Vidrio Soplado

ACABADOS

Metal:
Oro Brillo / Oro Mate / Negro
Mate / Cromo

BOMBILLA INCLUIDA

B034/COB
B033/COB

ESPECIFICACIONES

E27 - B033/COB (opal) incluida
3W - 3000K, 220-240 V,
50/60 Hz, IP20, Clase I

ETIQUETA ENERGÉTICA

A ++

TECHNICAL

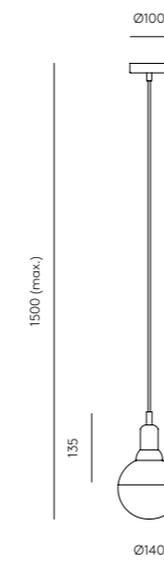

YOYO

C1222

Designed by Pepe Fornas, 2016

DESCRIPTION

MATERIALS

Steel

FINISHES

Metal:
Matt Black

Difusser:
Shinny Gold / Chrome /
Matt Black / Matt White

RECOMMENDED BULB

B005

SPECIFICATIONS

G9 Led Bulbs (Included)
3 x 3W - 3000K
220-240 V, 50/60 Hz
IP20, Class I

ENERGY LABEL

A ++

⊕ IP20 CE   

MATERIALES

Acero

ACABADOS

Metal:
Negro Mate

Difusor:
Oro Brillo / Cromo /
Negro Mate / Blanco Mate

BOMBILLA RECOMENDADA

B005

ESPECIFICACIONES

Bombillas G9 Led (Incluida)
3 x 3W - 3000K
220-240 V, 50/60 Hz
IP20, Clase I

ETIQUETA ENERGÉTICA

A ++

TECHNICAL

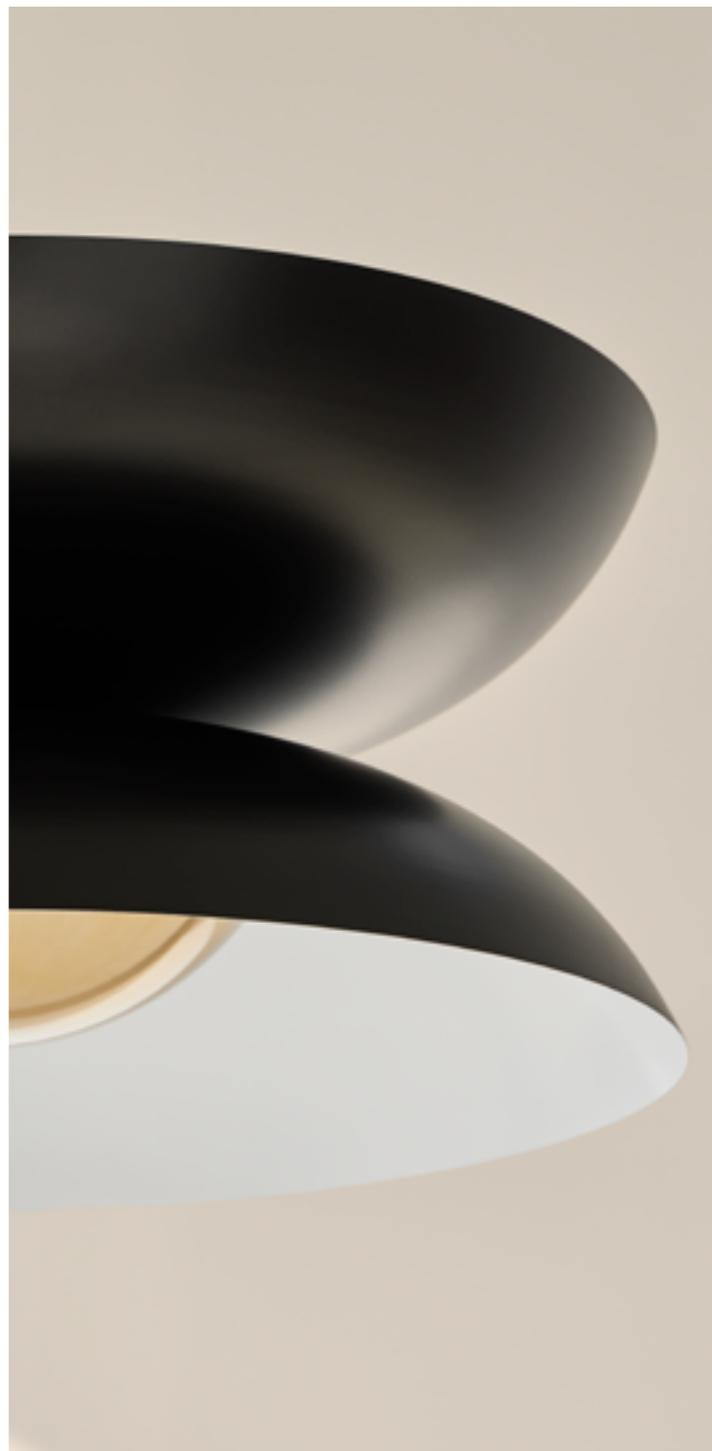
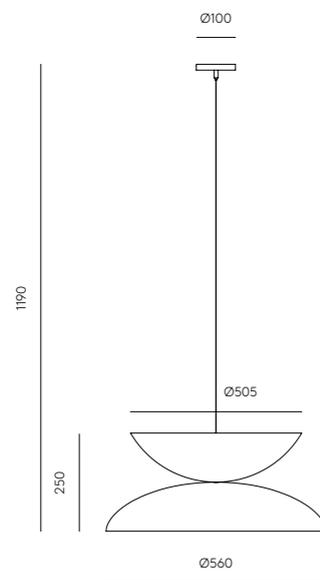

Puerto Escondido, México

LIND

Pendant lamp

C1220

Designed by Agus Gascón, 2020

DESCRIPTION

MATERIALS

Steel / Alabaster

FINISHES

Metal:
Matt Brass

Shade:
Alabaster

RECOMMENDED BULB

B005/5W

SPECIFICATIONS

G9 Led Bulb (Included)
5W - 2700K
220-240 V, 50/60 HZ
IP20, Class I

ENERGY LABEL

A++



MATERIALES

Acero / Alabastro

ACABADOS

Metal:
Oro Mate

Tulipa:
Alabastro

BOMBILLA RECOMENDADA

B005/5W

ESPECIFICACIONES

Bombilla G9 Led (Incluida)
5W - 2700K
220-240 V, 50/60 HZ
IP20, Clase I

ETIQUETA ENERGÉTICA

A++

TECHNICAL

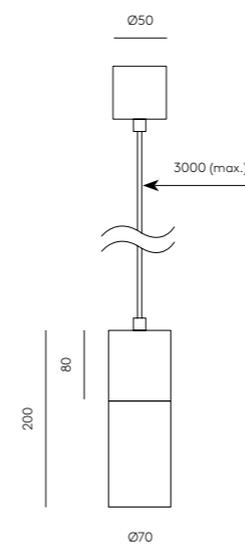

BALL

Pendant lamp

C1215

Designed by AC Studio, 2017

DESCRIPTION

MATERIALS

Steel / Blown Glass

FINISHES

Metal:
Matt Black
Matt Brass

Vidrio:
Opal
Clear

RECOMMENDED BULB

B005 /5W

SPECIFICATIONS

G9 Led Bulbs (Incluida)
5W - 2700K
220-240 V, 50/60 Hz
IP20, Class I

ENERGY LABEL

A ++

⊕ IP20 CE 

MATERIALES

Acero / Vidrio Soplado

ACABADOS

Metal:
Negro Mate
Oro Mate

Cristal:
Opal
Transparente

BOMBILLA RECOMENDADA

B005 /5W

ESPECIFICACIONES

Bombillas G9 Led (Incluida)
5W - 2700K
220-240 V, 50/60 Hz
IP20, Clase I

ETIQUETA ENERGÉTICA

A ++

TECHNICAL

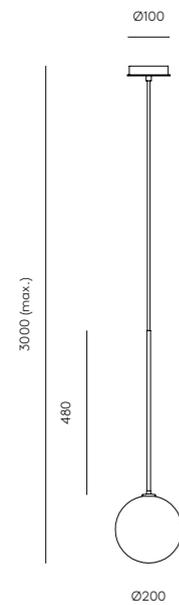

Riga, Lithuania



ATOM

Pendant lamp

C1214/8

Designed by AC Studio, 2016



DESCRIPTION

MATERIALS

Steel / Blown Glass

FINISHES

Metal:
Matt Black
Matt Brass
Vidrio:
Opal
Clear

RECOMMENDED BULB

B005 /5W

SPECIFICATIONS

G9 Led Bulbs (Included)
8 x 5W - 2700K
220-240 V, 50/60 Hz
IP20, Class I

ENERGY LABEL

A ++



MATERIALES

Acero / Vidrio Soplado

ACABADOS

Metal:
Negro Mate
Oro Mate
Cristal:
Opal
Transparente

BOMBILLA RECOMENDADA

B005 /5W

ESPECIFICACIONES

Bombillas G9 Led (Incluida)
8 x 5W - 2700K
220-240 V, 50/60 Hz
IP20, Clase I

ETIQUETA ENERGÉTICA

A ++

TECHNICAL

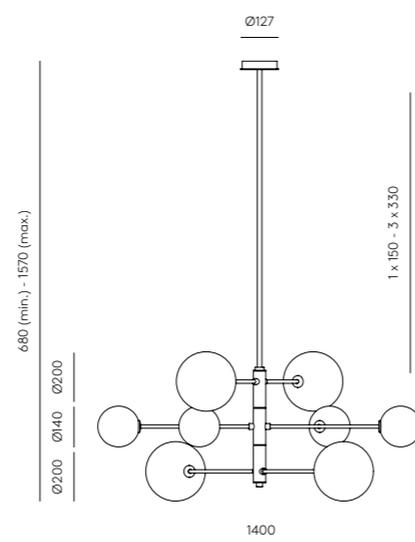

CUBE · X

Pendant lamp

C1213

Designed by AC Studio, 2016



DESCRIPTION

MATERIALS

Steel

FINISHES

Metal:
Chrome
Shiny Gold

SIZES

44 X 44 X 44 - 40W LED 3000K
60 X 40 X 35 - 45W LED 3000K
65 X 65 X 65 - 55W LED 3000K
90 X 90 X 90 - 75W LED 3000K

SPECIFICATIONS

Strip Led - 24 V, 50/60 Hz
IP20, Class I

ENERGY LABEL

A ++



MATERIALES

Acero

ACABADOS

Metal:
Cromo
Oro brillo

BOMBILLA RECOMENDADA

44 X 44 X 44 - 40W LED 3000K
60 X 40 X 35 - 45W LED 3000K
65 X 65 X 65 - 55W LED 3000K
90 X 90 X 90 - 75W LED 3000K

ESPECIFICACIONES

Tira Led - 24 V, 50/60 Hz
IP20, Clase I

ETIQUETA ENERGÉTICA

A ++

TECHNICAL

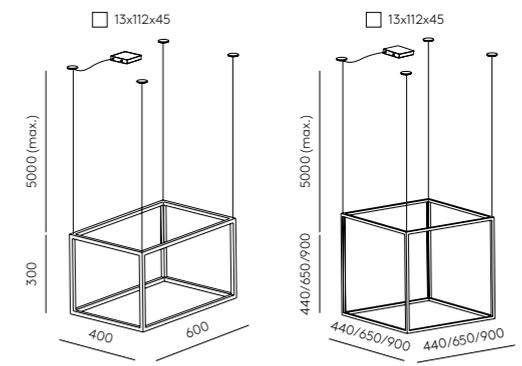

MIKA

Pendant lamp

C1204

Designed by AC Studio, 2016



DESCRIPTION

MATERIALS

Steel

FINISHES

Canopy, ring and cable:
Black

Body:

Matt black
Matt White
Shiny Gold
Bronze

SPECIFICATIONS

Integrated COB Led
3W - 2700K TRIAC dimmable
24V, 50/60 Hz
IP20, Class I

ENERGY LABEL

A ++



MATERIALES

Acero

ACABADOS

Floron, aro y cable:
Negro

Cuerpo:

Negro mate
Blanco mate
Oro brillo
Bronze

ESPECIFICACIONES

Led COB integrado
3W - 2700K TRIAC regulable
24V, 50/60 Hz
IP20, Clase I

ETIQUETA ENERGÉTICA

A ++

TECHNICAL

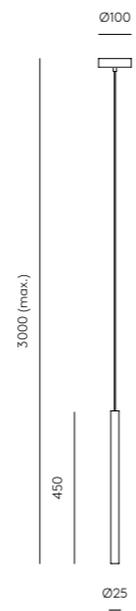

MIKA MULTI

Pendant lamp

C1204/8

Designed by AC Studio, 2016



DESCRIPTION

MATERIALS

Steel

FINISHES

Canopy, ring and cable:
Black

Body:

Matt black
Matt White
Shiny Gold
Bronze

SPECIFICATIONS

Integrated COB Led
8 x 3W - 2700K TRIAC dimmable
24V, 50/60 Hz
IP20, Class I

ENERGY LABEL

A ++



MATERIALES

Acero

ACABADOS

Floron, aro y cable:
Negro

Cuerpo:

Negro mate
Blanco mate
Oro brillo
Bronze

ESPECIFICACIONES

Led COB integrado
8 x 3W - 2700K TRIAC regulable
24V, 50/60 Hz
IP20, Clase I

ETIQUETA ENERGÉTICA

A ++

TECHNICAL

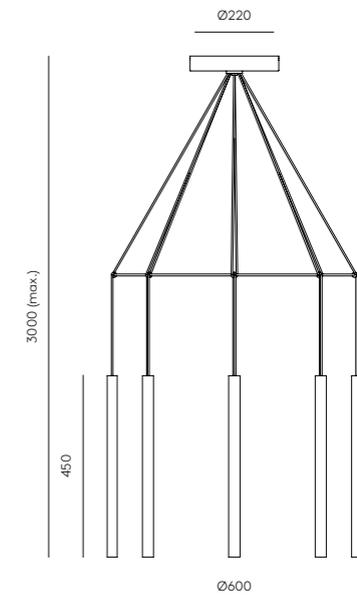

BIGCOSS

C1203/80

Designed by AC Studio, 2023

DESCRIPTION

MATERIALS

Metal / Acrylic / Crystal

FINISHES

Body:
Matt Black

Diffuser:
Mirror

SPECIFICATIONS

LED Strip 25W 2700K TRIAC
Dimmable + LED Spotlight
15W 2700K TRIAC dimmable
24V, 50/60Hz
IP20, Class I

ENERGY LABEL

A ++

⊕ IP20 CE   

MATERIALES

Metal / Acrílico / Cristal

ACABADOS

Cuerpo:
Negro Mate

Difusor:
Espejo

ESPECIFICACIONES

Tira LED 25W 2700K TRIAC
regulable + Proyector LED
15W 2700K TRIAC regulable
24 V, 50/60 Hz
IP20, Clase I

ETIQUETA ENERGÉTICA

A ++

TECHNICAL

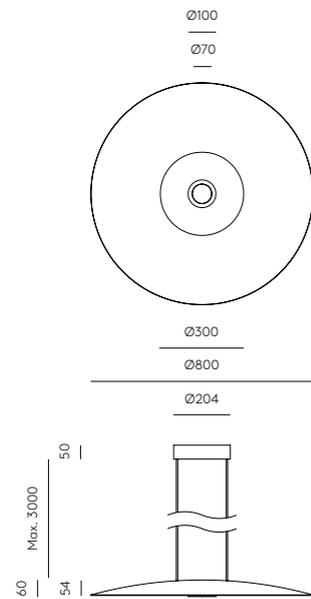

ANET

Pendant lamp

C1206

Designed by Agus Gascón, 2018

DESCRIPTION

MATERIALS

Steel / Marble / Blown Glass

FINISHES

Metal:
Matt Black
Bronze
Aged Gold

Marble:

White
Brown
Green

Glass:

Opal

RECOMMENDED BULB

B005 /5W

SPECIFICATIONS

BULB G9 LED (INCLUDED)
5W - 3000K
220-240 V, 50/60 HZ
IP20, CLASS I

ENERGY LABEL

A ++

⊕ IP20 CE   

MATERIALES

Acero / Mármol / Vidrio Soplado

ACABADOS

Metal:
Negro Mate
Bronce
Oro Envejecido

Mármol:

Blanco
Marrón
Verde

Cristal:

Opal

BOMBILLA RECOMENDADA

B005/5W

ESPECIFICACIONES

Bombilla G9 Led (Incluida)
5W - 3000K
220-240 V, 50/60 Hz
IP20, Clase I

ETIQUETA ENERGÉTICA

A ++

TECHNICAL

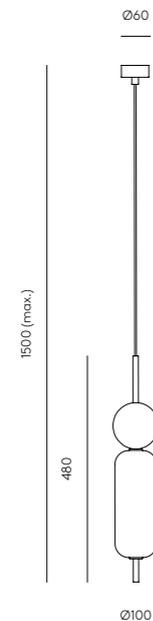

MARU

Pendant lamp

C1194

Designed by JF Sevilla, 2015

DESCRIPTION

MATERIALS

Steel

FINISHES

Metal:
Matt Black - Matt Brass
Matt Black - Matt Black

SPECIFICATIONS

INTEGRATED LED
3W - 3150K
12 V, 50/60 HZ
IP20, CLASS I

ENERGY LABEL

A ++

⊕ IP20 CE   

MATERIALES

Acero

ACABADOS

Metal:
Negro Mate - Oro Mate
Negro Mate - Negro Mate

ESPECIFICACIONES

LED integrado
3W - 3150K
12 V, 50/60 Hz
IP20, Clase I

ETIQUETA ENERGÉTICA

A ++

TECHNICAL

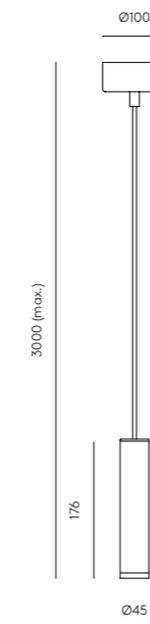

DAMO

Pendant lamp

C1191

Designed by AC Studio, 2015

DESCRIPTION

MATERIALS

Steel / Glass

FINISHES

Metal:
Matt Black
Matt Brass

Diffuser:
Opal

RECOMMENDED BULB

B211 (7, 9, 11W)

SPECIFICATIONS

2 x E27 Max. 60W
(Not included)
220-240 V, 50/60 Hz
IP20, Class I

ENERGY LABEL

A ++



MATERIALES

Acero / Vidrio

ACABADOS

Metal:
Negro Mate
Oro Mate

Difusor:
Cristal Opal

BOMBILLA RECOMENDADA

B211 (7, 9, 11W)

ESPECIFICACIONES

2 x E27 Max. 60W
(No incluida)
220-240 V, 50/60 Hz
IP20, Clase I

ETIQUETA ENERGÉTICA

A ++

TECHNICAL

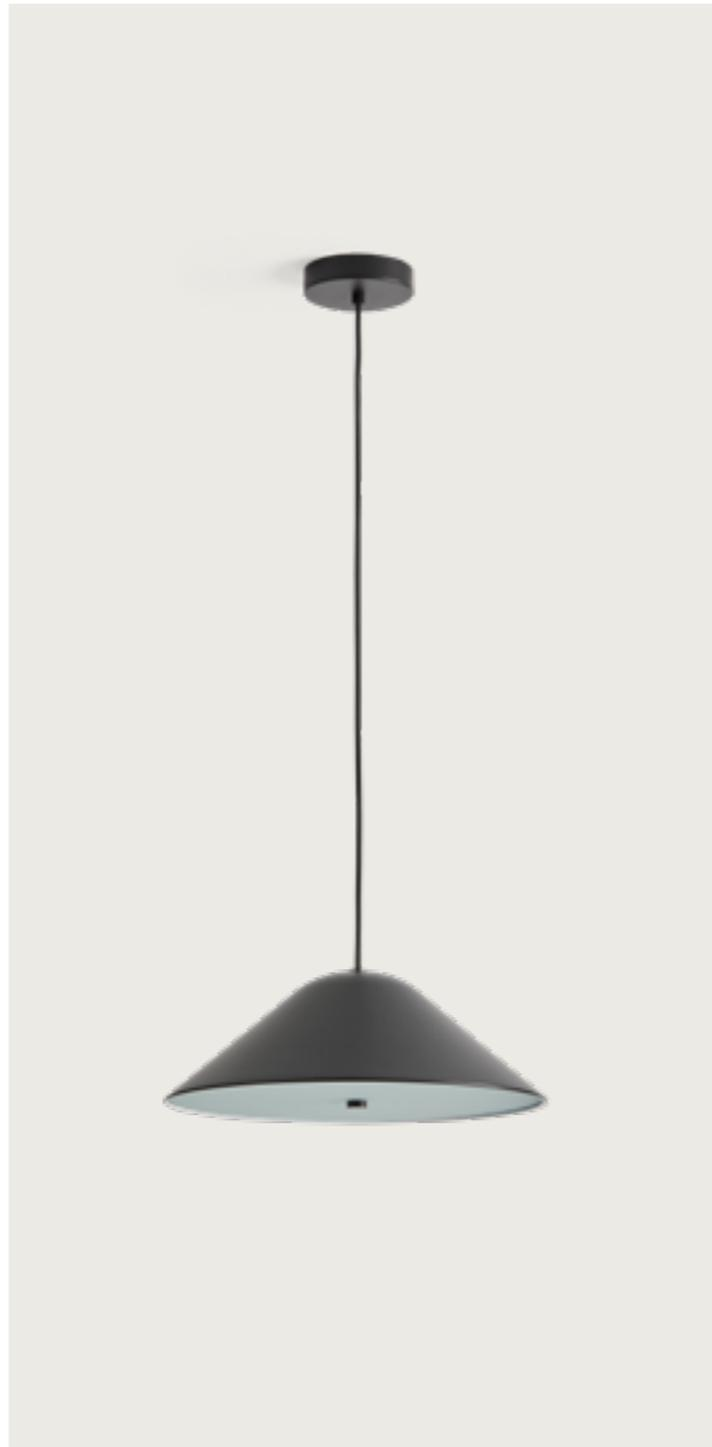
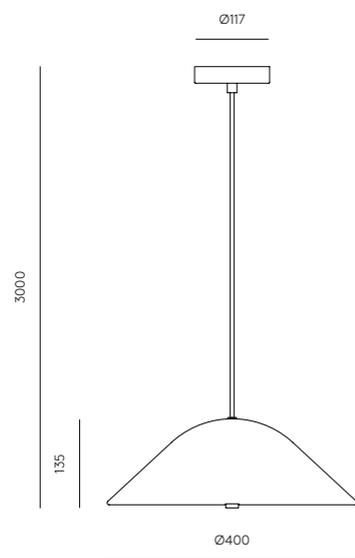

ELLA

Pendant lamp

C1158

Designed by AC Studio, 2020

DESCRIPTION

MATERIALS

Steel / Acrylic

FINISHES

Big Dome:
Matt Black - Exterior
Matt White - Interior

Diffuser:
Matt Black
Matt Brass
Shiny Gold
Chrome

SPECIFICATIONS

Integrated 9W LED
2700K TRIAC dimmable
24V, 50/60 Hz

ENERGY LABEL

A ++



MATERIALES

Metal / Acrílico

ACABADOS

Cúpula grande:
Negro Mate - Exterior
Blanco Mate - Interior

Difusor:
Negro Mate
Oro mate
Oro brillo
Cromo

ESPECIFICACIONES

LED integrado 9W
2700K TRIAC regulable
24V, 50/60 Hz

ETIQUETA ENERGÉTICA

A ++

TECHNICAL

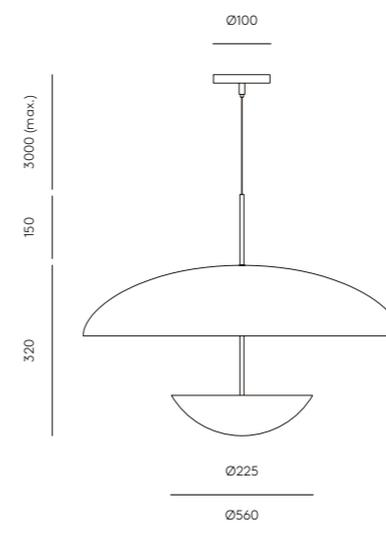

ENDO

Pendant lamp

C1156

Designed by Pepe Fornas, 2013

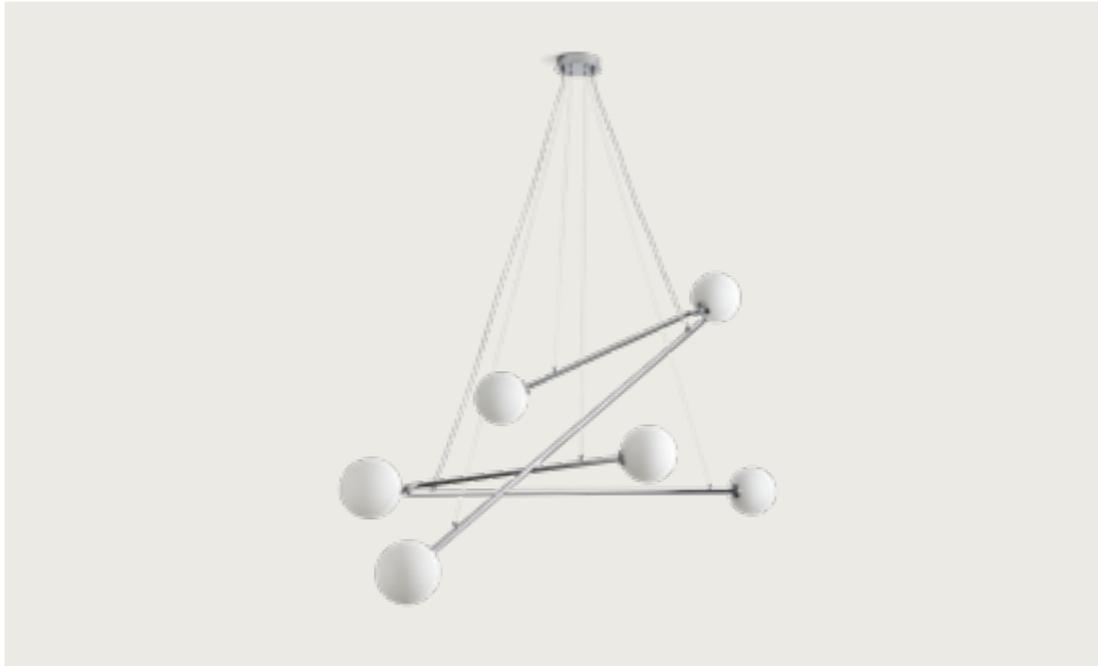

DESCRIPTION

MATERIALS
Steel / Glass

FINISHES

Metal:
Matt Black
Chrome
Glass:
Opal

RECOMMENDED BULB
B005/5W

SPECIFICATIONS
G9 LED Bulbs (Included)
6 x 5W - 2700K
220-240 V, 50/60 Hz
IP20, Class I

ENERGY LABEL
A ++



TECHNICAL

MATERIALES
Acero / Vidrio

ACABADOS

Metal:
Negro Mate
Cromo
Vidrio:
Opal

BOMBILLA RECOMENDADA
B005/5W

ESPECIFICACIONES
Bombillas G9 LED (Incluidas)
6 x 5W - 2700K
220-240 V, 50/60 Hz
IP20, Clase I

ETIQUETA ENERGÉTICA
A ++

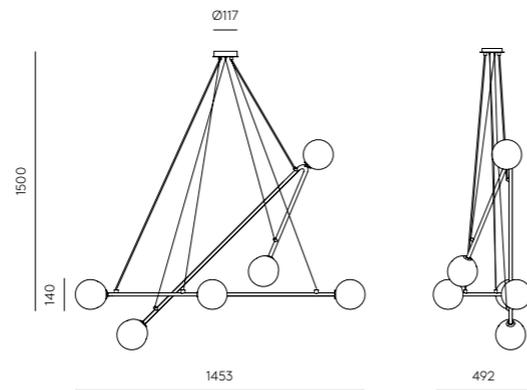

Geneva, Switzerland





CHAPEAU

Pendant lamp

C1157
Designed by Paloma Marín, 2022

DESCRIPTION

MATERIALS Steel / Ceramics	MATERIALES Acero / Cerámica
FINISHES Metal: Matt brass Matt black Matt white Ceramics: Hand painted See colour palette Image colour: Left: Green leaf Right: Silhouette	ACABADOS Metal: Oro mate Negro mate Blanco mate Cerámica: Pintada a mano Consultar paleta de colores Color en imagen: Izda: Verde hoja Dcha: Silhouette
SPECIFICATIONS (UE) E27 max. 11W LED (Not included) 230V, 50/60 Hz IP20, Class I Hand painted	ESPECIFICACIONES (UE) E27 max. 11W LED (No incluida) 230V, 50/60 Hz IP20, Clase I Pintado a mano
ENERGY LABEL A ++	ETIQUETA ENERGÉTICA A ++

IP20 CE RoHS V A++

TECHNICAL

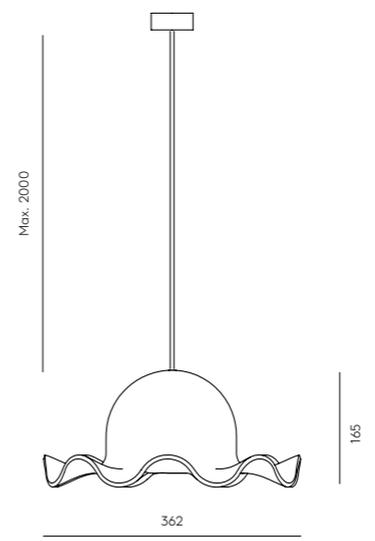

CORA

Pendant lamp

C1129

Designed by AC Studio, 2023

DESCRIPTION

MATERIALS

Steel / Ceramics

FINISHES

Metal:

Shiny gold
Chrome
White
Black

Ceramics:

Hand painted
See colour palette

Image colour:

Left: Taupe
Right: White

SPECIFICATIONS (UE)

Direct LED plate 7W 3000K
220-240V, 50/60Hz
IP20, Class I

ENERGY LABEL

A ++

⊕ IP20 CE   

MATERIALES

Acero / Cerámica

ACABADOS

Metal:

Oro Brillo
Cromo
Blanco
Negro

Cerámica:

Pintada a mano
Consultar paleta de colores

Color ne imagen:

Izda: Topo
Dcha: Blanco

ESPECIFICACIONES (UE)

Placa LED directa 7W 3000K
220-240 V, 50/60 Hz
IP20, Clase I

ETIQUETA ENERGÉTICA

A ++

TECHNICAL

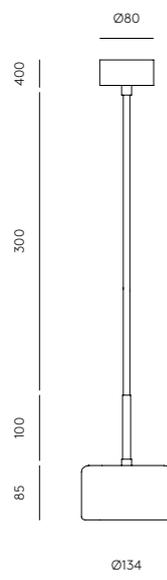

Istanbul, Turkey

PTAN

Pendant lamp

C1154

Designed by Fornasevi, 2018

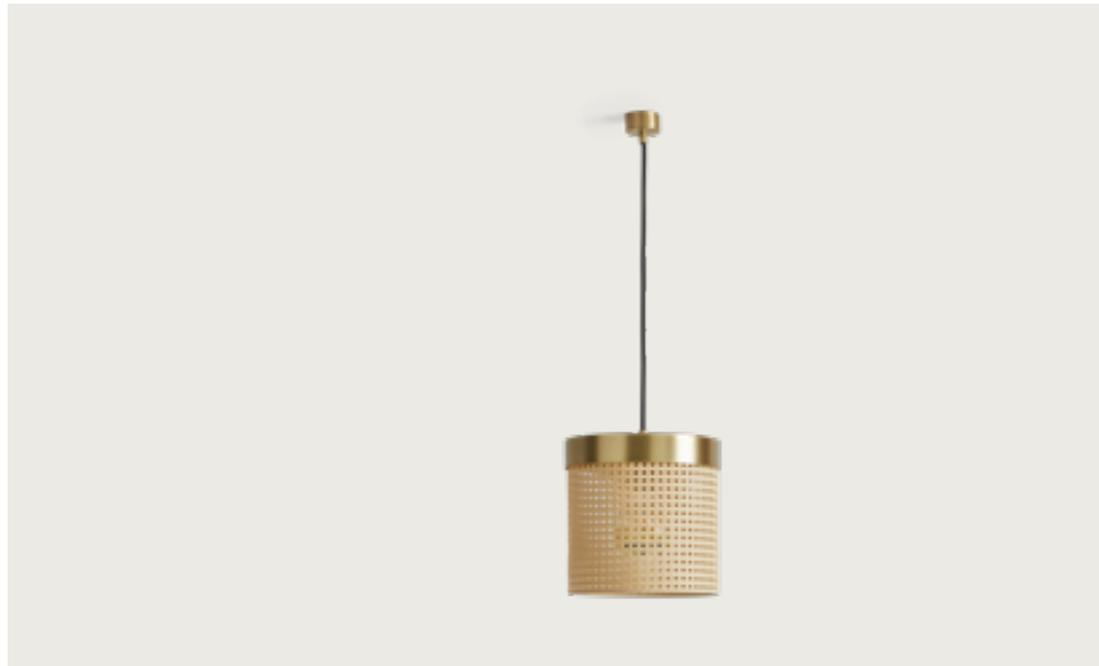

DESCRIPTION

MATERIALS

Steel / Rattan

FINISHES

Metal:
Matt Brass
Matt Black

Rattan:
Natural
Black

RECOMMENDED BULB

B033/COB (Opal)
B035/GOLD (Mirrored)

SPECIFICATIONS

E27 Max. 60W
(Not included)
220-240 V, 50/60 Hz
IP20, Class I

ENERGY LABEL

A ++



MATERIALES

Acero / Ratán

ACABADOS

Metal:
Oro Mate
Negro Mate

Ratán:
Natural
Negro

BOMBILLA RECOMENDADA

B033/COB (Opal)
B035/ORO (Espejada)

ESPECIFICACIONES

E27 Max. 60W
(No incluida)
220-240 V, 50/60 Hz
IP20, Clase I

ETIQUETA ENERGÉTICA

A ++

TECHNICAL

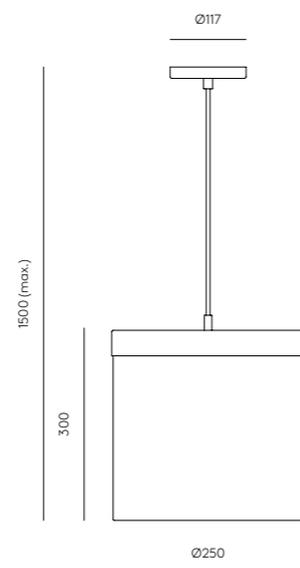

COPO

Pendant lamp

C1085

Designed by Pepe Fornas, 2021

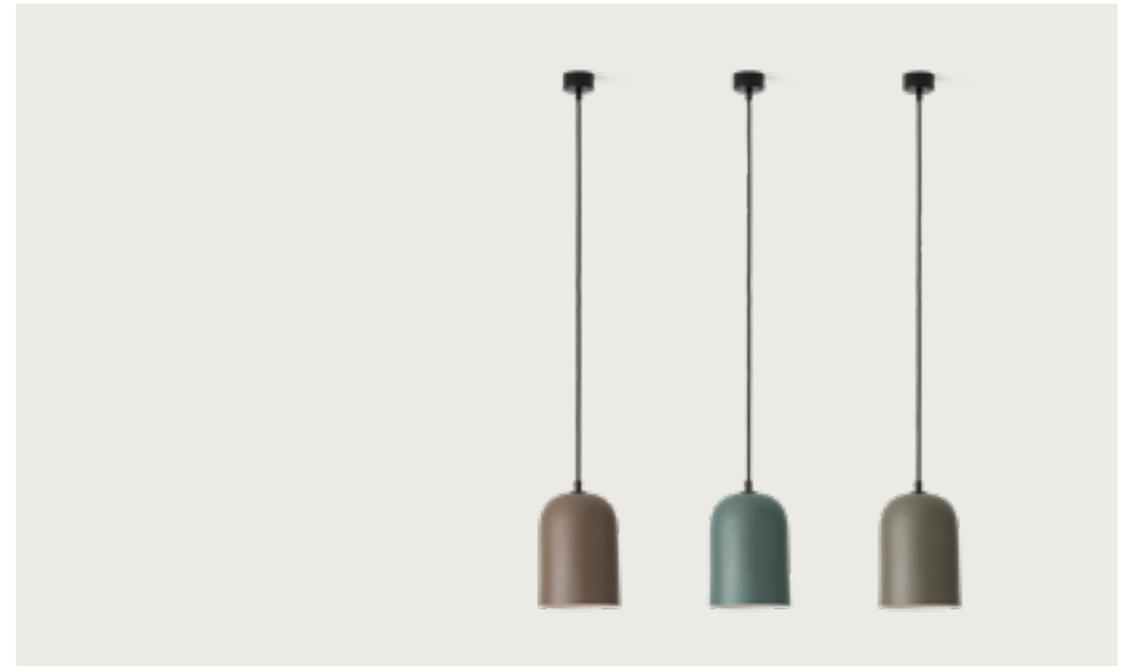

DESCRIPTION

MATERIALS

Steel / Ceramic

FINISHES

Metal:
Matt gold
Shiny gold
Matt black
Matt white

Ceramic:
Left to right colors:
Vintage brown
Dunkel green
Green Leaf
Color palette on page 432

SPECIFICATIONS

E27max. 11WLED (not included)
230V, 50/60 Hz, IP20, Class I

ENERGY LABEL

A ++

HAND PAINTED



MATERIALES

Acero / Cerámica

ACABADOS

Metal:
Oro mate
Oro Brillo
Negro mate
Blanco mate

Cerámica:
Colores de izq. a dcha:
Marrón vintage
Verde dunkel
Verde hoja
Paleta de colores en la pág. 432

ESPECIFICACIONES

E27 max. 11W LED (no incluida)
230V, 50/60 Hz IP20, Clase I

ETIQUETA ENERGÉTICA

A ++

PINTADO A MANO

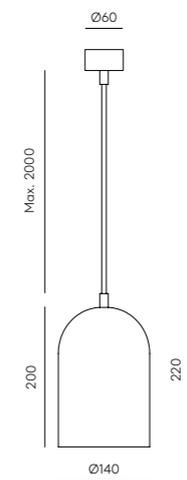

C1085



BELL

Pendant lamp

C1084

Designed by Pepe Fornas, 2021

DESCRIPTION

MATERIALS

Steel / Ceramic / Marble

FINISHES

Metal:
 Matt gold
 Shiny gold
 Matt black
 Matt white

Marble:
 Natural
 White
 Black
 Green
 Brown

Ceramic:
 Hand painted
 Check colour palette

Image colours:
 Left: Terracotta + white marble / Nude
 Right: Ash grey + green marble

SPECIFICATIONS

E27max. 11WLED (not included)
 230V, 50/60 Hz, IP20, Class I

ENERGY LABEL

A ++

⊕ IP20 CE

MATERIALES

Acero / Mármol / Cerámica

ACABADOS

Metal:
 Oro mate
 Oro Brillo
 Negro mate
 Blanco mate

Mármol:
 Natural
 Blanco
 Negro
 Verde
 Marrón

Cerámica:
 Pintada a mano
 Consulta paleta de colores

Colores en imagen:
 Izda: Terracotta + mármol blanco / Nude
 Dcha: Gris ceniza + mármol verde

ESPECIFICACIONES

E27 max. 11W LED (no incluida)
 230V, 50/60 Hz IP20, Clase I

ETIQUETA ENERGÉTICA

A ++

TECHNICAL

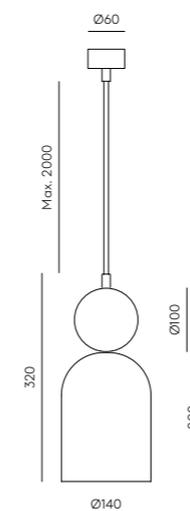

C1084



ALPHA

Pendant lamp

C1083

Designed by AC Studio, 2019

DESCRIPTION

MATERIALS

Steel

FINISHES

Metal:

Black
Gold
Chrome
White

Shade:

Check color Palette
Image color: Banana Green

POSSIBLE MODIFICATIONS

Special finish - Extracost

RECOMMENDED BULB

B211 (7, 9, 11W)

SPECIFICATIONS

E27 Max. 60W (Not included)
220-240 V, 50/60 Hz, IP20,
Class I

ENERGY LABEL

A ++



MATERIALES

Acero

ACABADOS

Metal:

Negro
Oro
Cromo
Blanco

Tulipa:

Consultar paleta colores
Color en imagen: Banana Green

MODIFICACIONES POSIBLES

Acabado especial - Sobrecoste

BOMBILLA RECOMENDADA

B211 (7, 9, 11W)

ESPECIFICACIONES

E27 Max. 60W (No incluida)
220-240 V, 50/60 Hz, IP20,
Clase I

ETIQUETA ENERGÉTICA

A ++

TECHNICAL

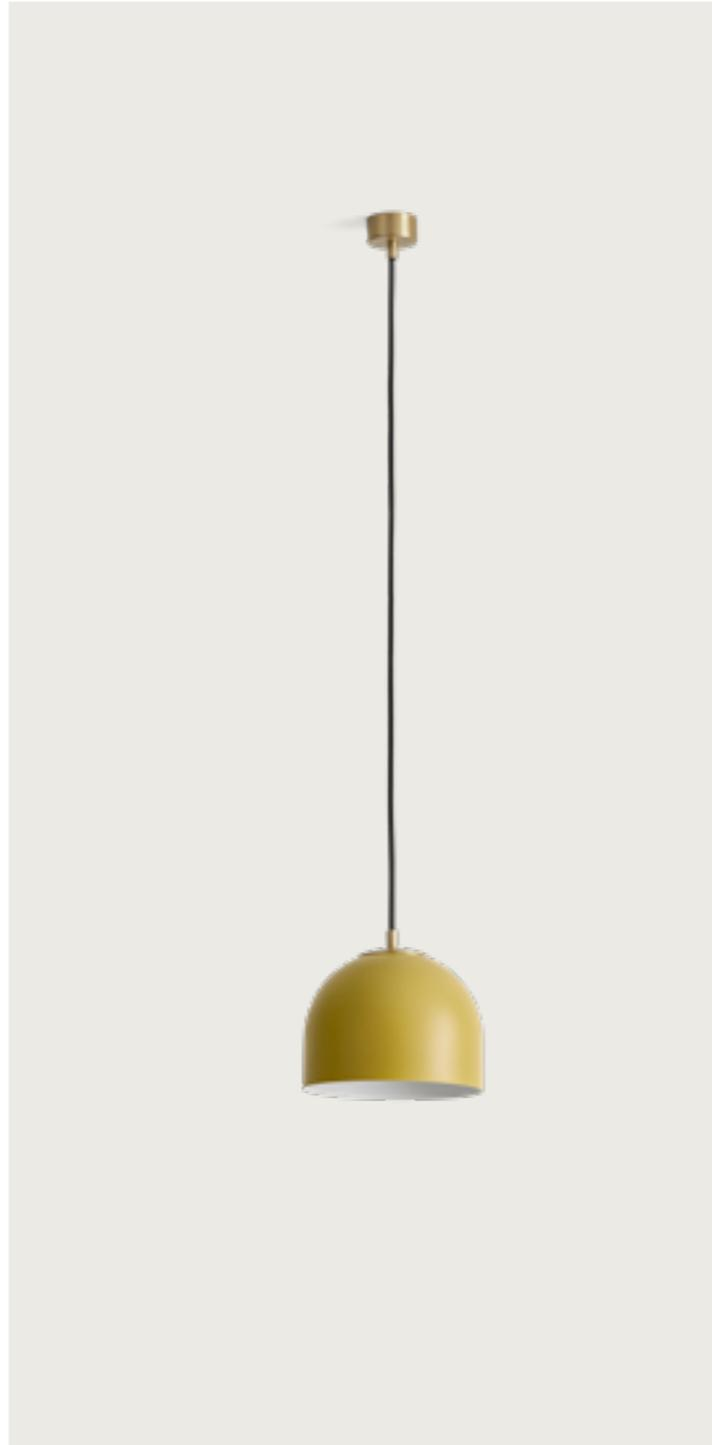
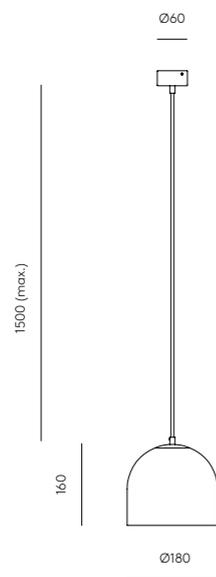

BETA

Pendant lamp

C1082

Designed by AC Studio, 2019

DESCRIPTION

MATERIALS

Steel

FINISHES

Metal:

Black
Gold
Chrome
White

Shade:

Check color Palette
Image color: Mineral red

POSSIBLE MODIFICATIONS

Special finish - Extracost

SPECIFICATIONS

E27 Max. 60W (Not included)
220-240 V, 50/60 Hz, IP20,
Class I

ENERGY LABEL

A ++



MATERIALES

Acero

ACABADOS

Metal:

Negro
Oro
Cromo
Blanco

Tulipa:

Consultar paleta Colores
Color en imagen: Rojo mineral

MODIFICACIONES POSIBLES

Acabado especial - Sobrecoste

ESPECIFICACIONES

E27 Max. 60W (No incluida)
220-240 V, 50/60 Hz, IP20,
Clase I

ETIQUETA ENERGÉTICA

A ++

TECHNICAL

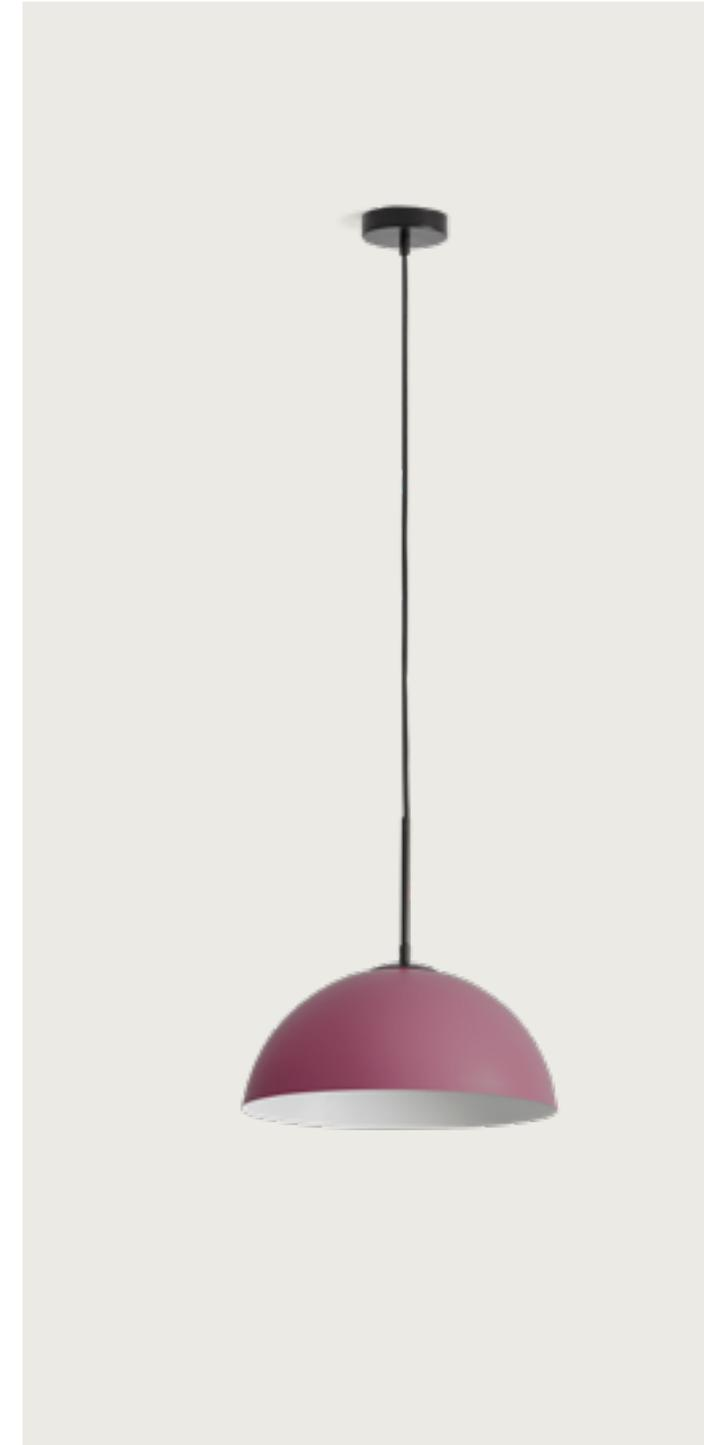
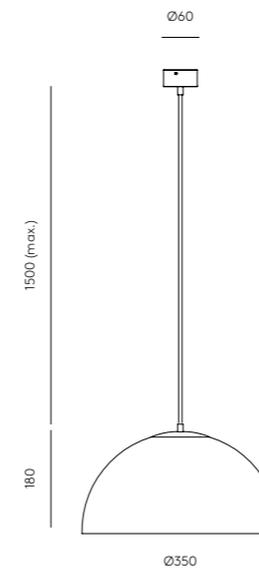

GAMMA

Pendant lamp

C1081

Designed by AC Studio, 2019

DESCRIPTION

MATERIALS

Steel

FINISHES

Diffuser:

Black
Chrome
Gold

Shade:

Image colours:
Up Make up,
Down Green Leaf.
Check color palette on page 425

POSSIBLE MODIFICATIONS

Special finish - Extracost
E27 Lamp holder

RECOMMENDED BULB

B033/COB (IF USED WITH E27)

SPECIFICATIONS

Led Diffuser 9W - 3000K
12 V, 50/60 Hz, IP20, Class I

ENERGY LABEL

A ++

IP20 CE RoHS A++

MATERIALES

Acero

ACABADOS

Difusor:

Negro
Cromo
Oro

Tulipa:

Colores en imagen: Arriba
Maquillaje, abajo verde hoja.
Consulta paleta de colores en
pág. 425

MODIFICACIONES POSIBLES

Acabado especial - Sobrecoste
Portalámparas E27

BOMBILLA RECOMENDADA

B033/COB (SI SE USA CON E27)

ESPECIFICACIONES

Difusor Led 9W - 3000K
12 V, 50/60 Hz, IP20, Clase I

ETIQUETA ENERGÉTICA

A ++

TECHNICAL

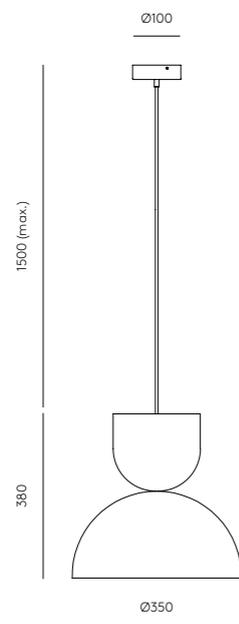

ELLEN

Pendant lamp

C1048

Designed by AC Studio, 2014

DESCRIPTION

MATERIALS

Steel

FINISHES

Metal:

Black
White
Shiny Gold
Chrome

RECOMMENDED BULB

B019

SPECIFICATIONS

E27 Max. 60W (Not included)
220-240 V, 50/60 Hz
IP20, Class I

ENERGY LABEL

A ++



MATERIALES

Acero

ACABADOS

Metal:

Negro
Blanco
Oro brillo
Cromo

BOMBILLA RECOMENDADA

B019

ESPECIFICACIONES

E27 Max. 60W (No incluida)
220-240 V, 50/60 Hz
IP20, Clase I

ETIQUETA ENERGÉTICA

A ++

TECHNICAL

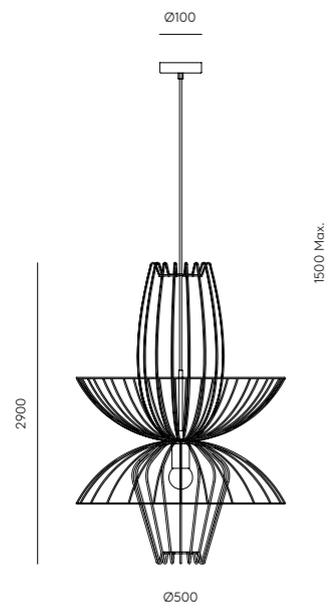

CRAWFORD

Pendant lamp

C1047

Designed by Pepe Fornas, 2014

DESCRIPTION

MATERIALS

Steel

FINISHES

Metal:

Black
White
Shiny Gold
Chrome

RECOMMENDED BULB

B035

SPECIFICATIONS

E27 Max. 60W (Not included)
220-240 V, 50/60 Hz
IP20, Class I

ENERGY LABEL

A ++



MATERIALES

Acero

ACABADOS

Metal:

Negro
Blanco
Oro brillo
Cromo

BOMBILLA RECOMENDADA

B035

ESPECIFICACIONES

E27 Max. 60W (No incluida)
220-240 V, 50/60 Hz
IP20, Clase I

ETIQUETA ENERGÉTICA

A ++

TECHNICAL

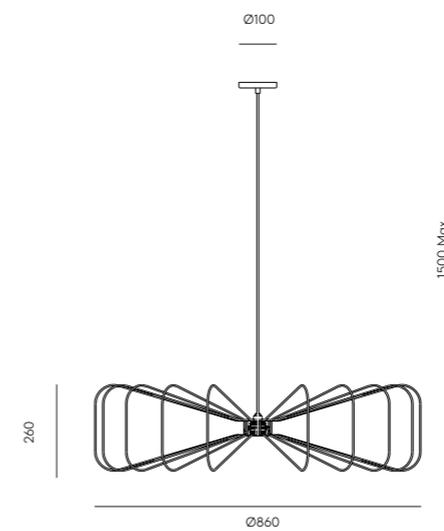

DISC

Pendant lamp

C1038

Designed by JF Sevilla, 2014



DESCRIPTION

MATERIALS

Steel

FINISHES

Metal:
Black
White
Shiny Gold
Chrome
Matt Brass

AVAILABLE SIZES

Disc sizes Ø15, Ø25, Ø35 cm

RECOMMENDED BULB

B035/GOLD / B038

SPECIFICATIONS

E27 Max. 60W (Not included)
220-240 V, 50/60 Hz
IP20, Class I

ENERGY LABEL

A ++



MATERIALES

Acero

ACABADOS

Metal:
Negro
Blanco
Oro brillo
Cromo
Oro mate

MEDIDAS DISPONIBLES

Medidas disco Ø15, Ø25, Ø35 cm

BOMBILLA RECOMENDADA

B035/ORO / B038

ESPECIFICACIONES

E27 Max. 60W (No incluida)
220-240 V, 50/60 Hz
IP20, Clase I

ETIQUETA ENERGÉTICA

A ++

TECHNICAL

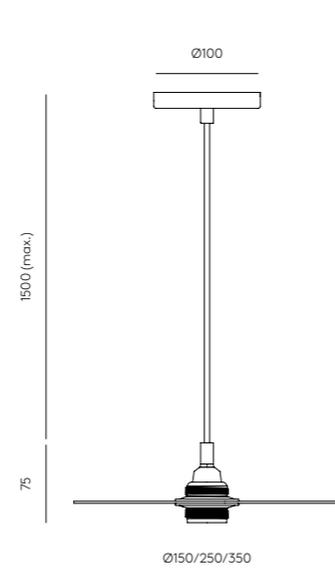

OPEN

Pendant lamp

C1024

Designed by AC Studio, 2009

DESCRIPTION

MATERIALS

Fabric Cotton / Steel

FINISHES

Fabric:
White
Grey
Black

Diffuser:
White

Fabric:
Chrome

RECOMMENDED BULB

B211 (7, 9, 11W)

SPECIFICATIONS

3 x E27 Max. 60W (Not included)
220-240 V, 50/60 Hz
IP20, Class I

ENERGY LABEL

A ++



MATERIALES

Loneta de Algodón / Acero

ACABADOS

Tela:
Blanco
Gris
Negro

Difusor:
Blanco

Metal:
Cromo

BOMBILLA RECOMENDADA

B211 (7, 9, 11W)

ESPECIFICACIONES

3 x E27 Max. 60W (No incluida)
220-240 V, 50/60 Hz
IP20, Clase I

ETIQUETA ENERGÉTICA

A ++

TECHNICAL

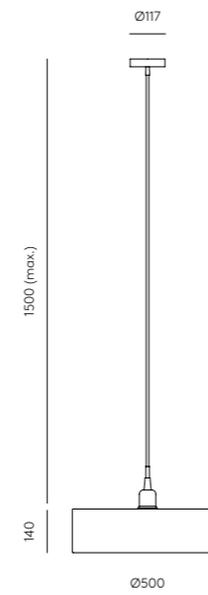

C1012

Pendant lamp

C1012

Designed by Agus Gascón, 2020

DESCRIPTION

MATERIALS
Steel / Glass

FINISHES

Metal:
Matt Black

Glass:
Clear
Black Smoked

SPECIFICATIONS

E27 3W 3000K (Included)
220-240 V, 50/60 Hz

ENERGY LABEL

A ++

LAMP HOLDER AND BULB
SOLD INDIVIDUALLY

⊕ IP20 CE   

MATERIALES
Acero / Vidrio

ACABADOS

Metal:
Negro Mate

Cristal:
Transparente
Fumé Negro

ESPECIFICACIONES

E27 3W 3000K (Incluida)
220-240 V, 50/60 Hz

ETIQUETA ENERGÉTICA

A ++

PORTALÁMPARAS Y BOMBILLA
SE VENDEN POR SEPARADO



TECHNICAL

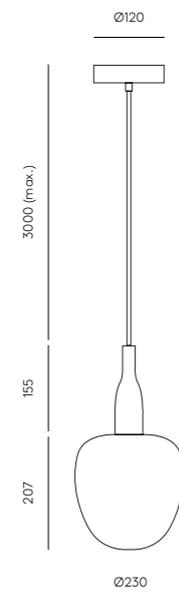

ANYA

Pendant lamp

C1010 + 1143 / 1144

Designed by Fornasevi, 2020



DESCRIPTION

MATERIALS
Natural Bamboo / Steel

FINISHES

C1010:
Matt Brass
Matt Black

Shade 1143/1144:
Bamboo-Black
Bronze

RECOMMENDED BULB
B052

SPECIFICATIONS

E27 Max. 60W (Not included)
220-240 V, 50/60 Hz
IP20, Class I

ENERGY LABEL
A ++

⊕ IP20 CE   

MATERIALES
Bambú Natural / Acero

ACABADOS

C1010:
Oro Mate
Negro Mate

Pantalla 1143/1144:
Bambú- Negro
Bronze

BOMBILLA RECOMENDADA
B052

ESPECIFICACIONES

E27 Max. 60W (No incluida)
220-240 V, 50/60 Hz
IP20, Clase I

ETIQUETA ENERGÉTICA
A ++

TECHNICAL

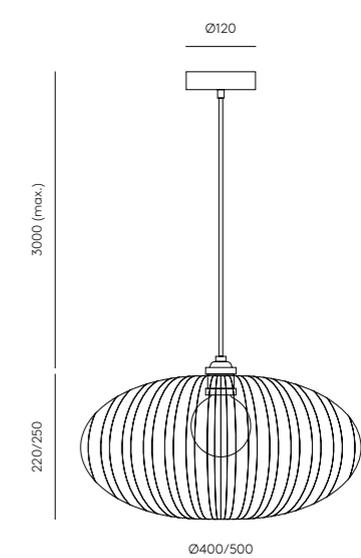

DOUL

Pendant lamp

T1310

Designed by Agus Gascón, 2023



DESCRIPTION

MATERIALS

Steel / Glass

FINISHES

Body:

Matt black / Matt Brass

Glass:

Striped glass - Transparent

SPECIFICATIONS (UE)

G4 LEDs 3W 2700K

Adjustable (Included)

220-240V, 50/60Hz

IP20, Class I

ENERGY LABEL

A ++



TECHNICAL

MATERIALES

Metal / Vidrio

ACABADOS

Cuerpo:

Negro mate / Oro envejecido

Cristal:

Cristal rayado - Transparente

ESPECIFICACIONES (UE)

G4 LED 3W 2700K

Regulable (Incluida)

220-240 V, 50/60 Hz

IP20, Clase I

ETIQUETA ENERGÉTICA

A ++

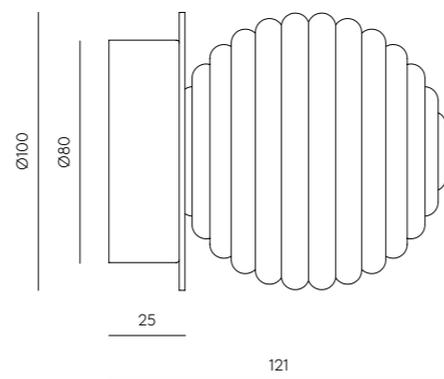

YCRO

Pendant lamp

T1297

Designed by JF Sevilla, 2022



DESCRIPTION

MATERIALS

Steel

FINISHES

Matt black & Matt gold
Matt Black

SPECIFICATIONS

Integrated LED chip

8W - 3000K

Dimmable by DALI/PUSH

220-240V - 24V - 50/60Hz

IP20 - Class I

ENERGY LABEL

A ++



TECHNICAL

MATERIALES

Acero

ACABADOS

Negro mate y oro mate
Negro mate

ESPECIFICACIONES

Chip LED integrado

8W - 3000K

Regulable por DALI/PUSH

220-240V - 24V - 50/60 Hz

IP20 - Clase I

ETIQUETA ENERGÉTICA

A ++

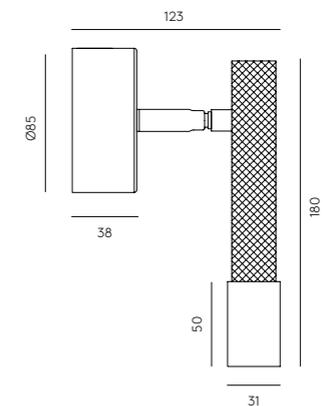

YCRO

Pendant lamp

T1297/4

Designed by JF Sevilla, 2022



YCRO



DESCRIPTION

MATERIALS

Steel

FINISHES

Matt black & Matt gold
Matt Black

SPECIFICATIONS

4x Integrated LED chip
8W - 3000K
Dimmable by DALI/PUSH
220-240V - 24V - 50/60Hz
IP20 - Class I

ENERGY LABEL

A ++

IP20 CE RoHS WEEE A++

TECHNICAL

MATERIALES

Acero

ACABADOS

Negro mate y oro mate
Negro mate

ESPECIFICACIONES

4x Chip LED integrado
8W - 3000K
Regulable por DALI/PUSH
220-240V - 24V - 50/60 Hz
IP20 - Clase I

ETIQUETA ENERGÉTICA

A ++

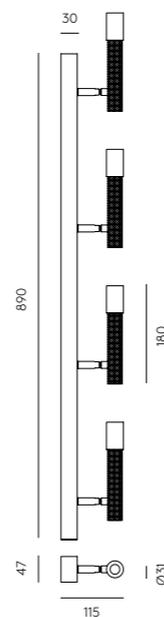

FOCUS

Pendant lamp

T1279

Designed by Pepe Fornas, 2021



DESCRIPTION

MATERIALS

Steel / Alabaster

FINISHES

Black
Aged gold
Anthracite
Nickel
Alabaster

SPECIFICATIONS

GU10 LED (included)
5W - 2700K
230 - 50/60Hz
IP20 - Class I

ENERGY LABEL

A ++

RECESSED LAMP

IP20 CE RoHS ENEC A++

MATERIALES

Acero / Alabastro

ACABADOS

Negro
Oro mate
Antracita
Niquel
Alabastro

ESPECIFICACIONES

GU10 LED (incluido)
5W - 2700K
230V - 50/60 Hz
IP20 - Clase I

ETIQUETA ENERGÉTICA

A ++

LÁMPARA EMPOTRABLE

TECHNICAL

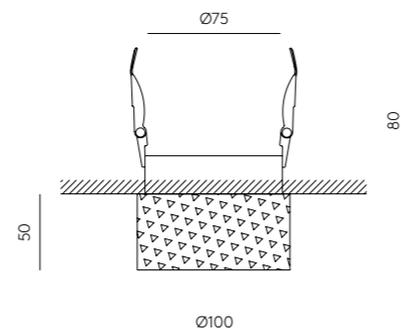

NOON

Pendant lamp

T1278/1

Designed by AC Studio, 2022

DESCRIPTION

MATERIALS

Steel

FINISHES

Blued
Matt black

SPECIFICATIONS

GU10 5W - 3000K (Included)
Dimmable by Triac
220-240V, 50/60Hz
IP20, Class I

ENERGY LABEL

A ++

MATERIALES

Acero

ACABADOS

Pavonado
Negro mate

ESPECIFICACIONES

GU10 5W - 3000K (Incluida)
Regulable por Triac
220-240 V, 50/60 Hz
IP20, Clase I

ETIQUETA ENERGÉTICA

A ++

IP20 CE RoHS ENEC A++

TECHNICAL

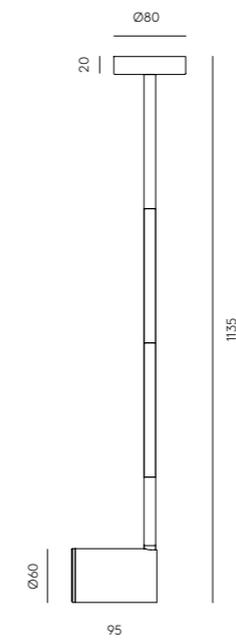

NOON

Pendant lamp

T1278/3

Designed by AC Studio, 2022



DESCRIPTION

MATERIALS

Steel

FINISHES

Blued
Matt black

SPECIFICATIONS

3 x GU10 5W - 3000K (Included)
Dimmable by Triac
220-240V, 50/60Hz
IP20, Class I

ENERGY LABEL

A ++



MATERIALES

Acero

ACABADOS

Pavonado
Negro mate

ESPECIFICACIONES

3 x GU10 5W - 3000K (Incluida)
Regulable por Triac
220-240 V, 50/60 Hz
IP20, Clase I

ETIQUETA ENERGÉTICA

A ++

TECHNICAL

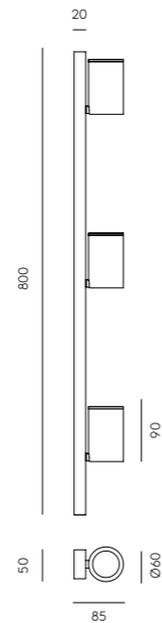

NOON

Pendant lamp

T1278

Designed by AC Studio, 2022



DESCRIPTION

MATERIALS

Steel

FINISHES

Blued
Matt black

SPECIFICATIONS

GU10 5W - 3000K (Included)
Dimmable by Triac
220-240V, 50/60Hz
IP20, Class I

ENERGY LABEL

A ++



MATERIALES

Acero

ACABADOS

Pavonado
Negro mate

ESPECIFICACIONES

GU10 5W - 3000K (Incluida)
Regulable por Triac
220-240 V, 50/60 Hz
IP20, Clase I

ETIQUETA ENERGÉTICA

A ++

TECHNICAL

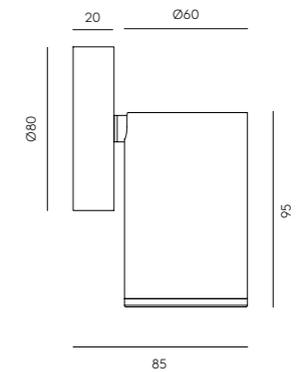



NOON



LATTO

Pendant lamp

T1268

Designed by AC Studio, 2023



DESCRIPTION

MATERIALS

Alluminium

FINISHES

Aged gold
Matt black
Anthracite

SPECIFICATIONS

GU10 LED 5W 2700K
Dimmable (Included)
220-240 V, 50/60 Hz
IP20, Class I

ENERGY LABEL

A ++

IP20 CE X V A++

TECHNICAL

MATERIALES

Aluminio

ACABADOS

Oro envejecido
Negro mate
Antracita

ESPECIFICACIONES

GU10 LED 5W 2700K
Regulable (Incluida)
220-240 V, 50/60 Hz
IP20, Clase I

ETIQUETA ENERGÉTICA

A ++

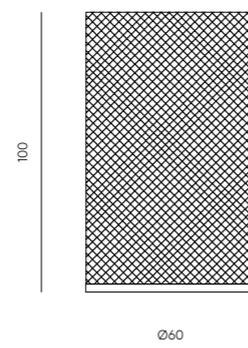

TAMB 30-50

Pendant lamp

T1019/30 - T1019/50

Designed by Pepe Fornas, 2021

DESCRIPTION

MATERIALS

Fabric Cotton

MATERIALES

Loneta de algodón

FINISHES

Shade:
White
Grey
Black

ACABADOS

Pantalla:
Blanco
Gris
Negro

Diffuser:
White

Difusor:
Blanco

SPECIFICATIONS

2x E27 Max. 60W
(Not included)
220-240V - 50/60Hz
IP20 - Class I

ESPECIFICACIONES

2x E27 Max. 60W
(No incluido)
220-240V - 50/60Hz
IP20 - Clase I

ENERGY LABEL

A ++

ETIQUETA ENERGÉTICA

A ++

RECOMMENDED BULB

B211 (7, 9, 11W)

BOMBILLA RECOMENDADA

B211 (7, 9, 11W)

⊕ IP20 CE    A++

TECHNICAL

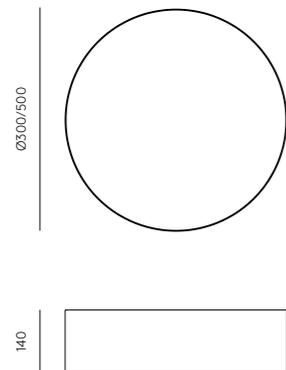

TAMB SQUARE

Pendant lamp

T1016

Designed by JF Sevilla, 2022

DESCRIPTION

MATERIALS

Fabric Cotton

MATERIALES

Loneta de algodón

FINISHES

Shade:
White
Grey
Black

ACABADOS

Pantalla:
Blanco
Gris
Negro

Diffuser:
White

Difusor:
Blanco

SPECIFICATIONS

2x E27 Max. 60W
(Not included)
220-240V - 50/60Hz
IP20 - Class I

ESPECIFICACIONES

2x E27 Max. 60W
(No incluido)
220-240V - 50/60Hz
IP20 - Clase I

ENERGY LABEL

A ++

ETIQUETA ENERGÉTICA

A ++

RECOMMENDED BULB

B211 (7, 9, 11W)

BOMBILLA RECOMENDADA

B211 (7, 9, 11W)

⊕ IP20 CE    A++

TECHNICAL

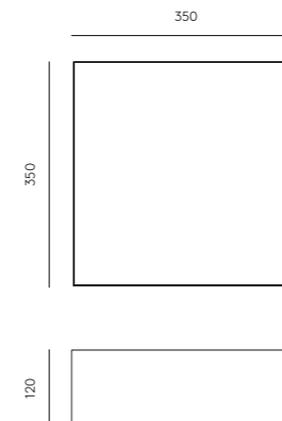

CREATE YOUR OWN PENDANT LAMP



CREA TU PROPIA
LÁMPRA COLGANTE

01

Which pendant is ideal for your lamp?

Search through our extensive catalog of individual pendants and choose the ideal one for your idea and space.

Qué colgante es ideal para su lámpara?

Busque entre nuestro amplio catálogo de colgantes individuales y elija el ideal para tu idea y espacio.

02

Shape and measurements of the canopy

Check the space where the lamp will be installed and check which size and shape best suits it.

Forma y medidas del florón

Revise el espacio donde se instalará la lámpara y compruebe qué tamaño y forma se adapta mejor al mismo.

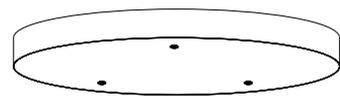

Round

300 x 300 x 45 mm
500 x 500 x 45 mm
700 x 700 x 45 mm

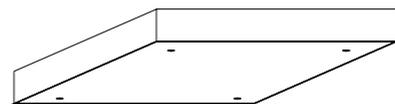

Square

400 x 400 x 45 mm
600 x 400 x 45 mm

Rectangle

700 x 250 x 45 mm
700 x 45 x 45 mm



** Para otras medidas y formas, consulte a nuestro departamento técnico y comercial.*

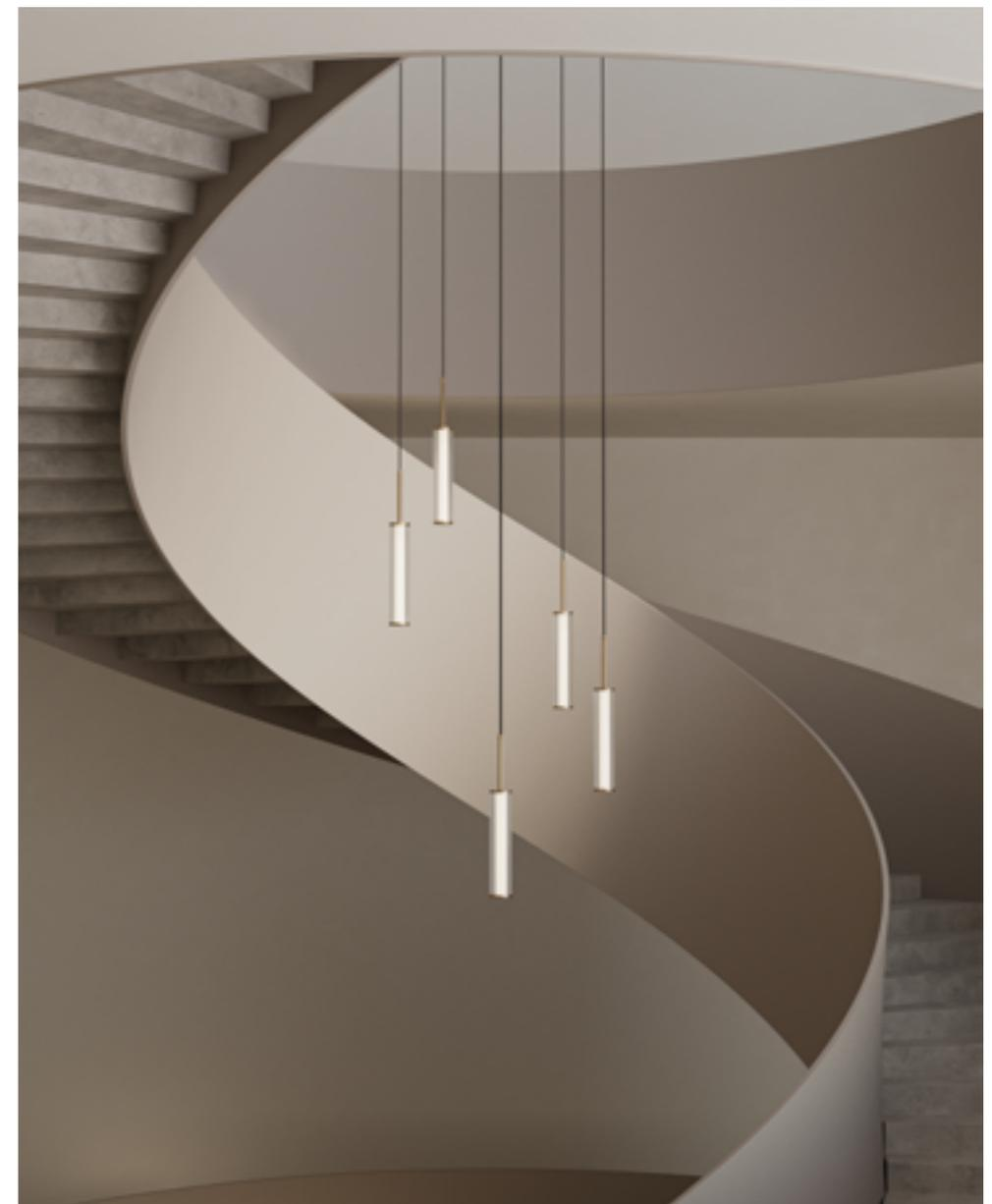

03

Finishes and canopy outsides

Our basic finishes are: Matt black and matt white.

You must inform us of the number of outlets and their distribution, as well as the length of each pendant.

Acabados y salidas del florón

Nuestros acabados básicos son: Negro mate y blanco mate.

Debe informarnos del número de salidas y su distribución, así como de la longitud de cada colgante.

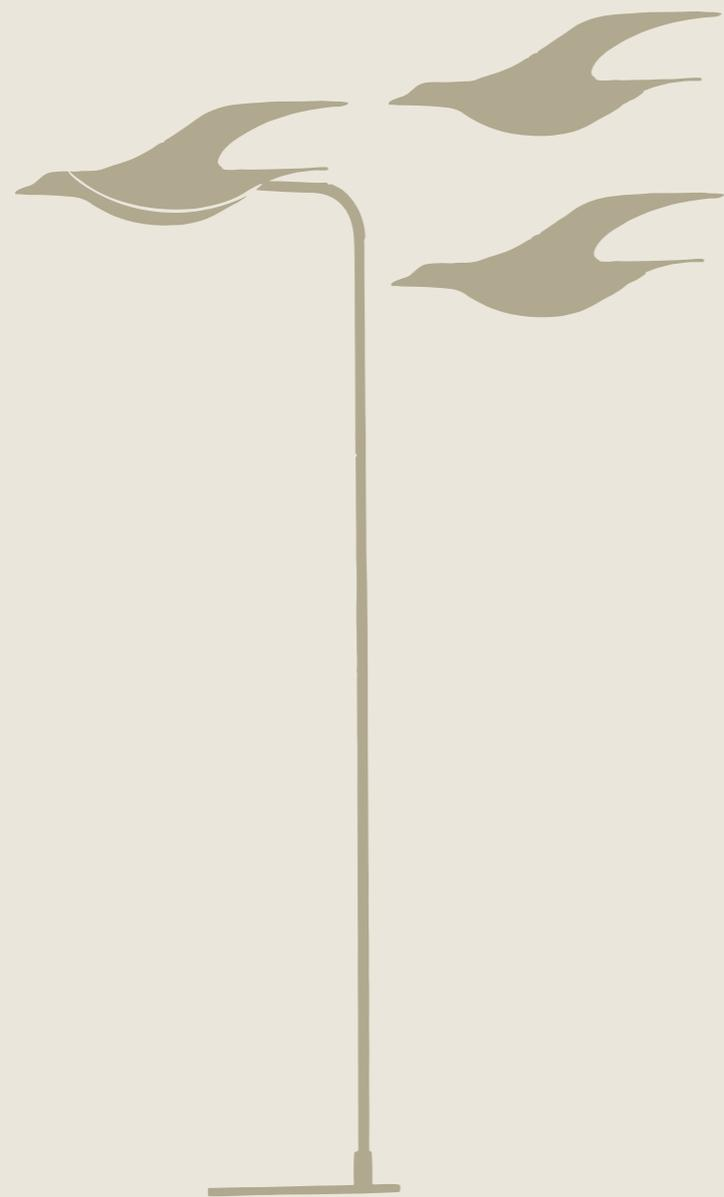

Floor

Lamps

- 264 **ELMA** · P1312
- 266 **ELLI** · P1311
- 268 **BION** · P1306
- 270 **FITO** · P1286
- 271 **FOCUS** · P1279
- 272 **NOOI** · P1276
- 274 **LYB** · P1274
- 276 **COLN** · P1267
- 277 **HINOO** · P1266
- 280 **ABBACUS** · P1258
- 281 **ARCTIC** · P1256
- 282 **MAHO** · P1254
- 284 **COT** · P1251
- 285 **FICUS** · P1243
- 286 **OHLALA** · P1242
- 287 **ARIO** · P1234
- 288 **LUCA** · P1237
- 290 **NERA** · P1229
- 291 **ATOM** · P1214
- 292 **COHEN GOLD** · P1196
- 293 **MARU** · P1194
- 294 **BOA** · P1193
- 295 **TRIPOD** · P1184
- 296 **DODO** · P1169
- 297 **RIU** · P1140
- 298 **HEDRA** · P1159
- 300 **ENDO** · P1156
- 302 **ONA** · P1029
- 303 **TEX** · P1026

ELMA

Floor lamp

P1312

Designed by Jose Fornas, 2023

DESCRIPTION

MATERIALS

Metal / Glass / Acrylic

FINISHES

Metal: Matte Black
/ Antique Gold

Glass:
Striped glass – Transparent

Acrylic: Opal

SPECIFICATIONS

LED strip 20W 2700K TRIAC
dimmable

24V, 50/60Hz

IP20, Class I

ENERGY LABEL

A ++

⊕ IP20 CE 

MATERIALES

Metal / Vidrio / Acrílico

ACABADOS

Metal: Negro mate
/ Oro envejecido

Cristal:
Cristal estriado – Transparente

Acrílico: Opal

ESPECIFICACIONES

Tira LED 20W 2700K TRIAC
regulable

24V, 50/60 Hz

IP20, Clase I

ETIQUETA ENERGÉTICA

A ++

TECHNICAL

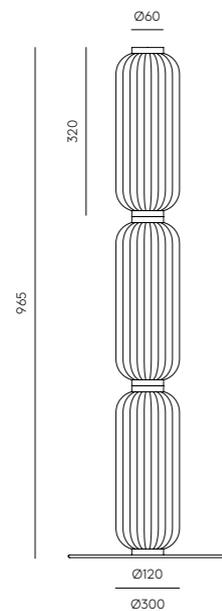

Milan, Italy



ELLI

Floor lamp

P1311

Designed by JF Sevilla, 2023



DESCRIPTION

MATERIALS

Metal / Acrylic / Marble

FINISHES

Metal: Matte Black
/ Antique Gold
Marble: Black
Acrylic: Opal

SPECIFICATIONS

LED strip 30W DALI/PUSH CCT
dimable (adjust power and
temperature)
24V, 50/60Hz
IP20, Class II

ENERGY LABEL

A ++



MATERIALES

Metal / Acrílico / Mármol

ACABADOS

Metal: Negro mate
/ Oro envejecido
Mármol: Negro
Acrílico: Opal

ESPECIFICACIONES

Tira LED 30W DALI/PUSH CCT
regulable (ajusta potencia y
temperatura)
24V, 50/60 Hz
IP20, Clase II

ETIQUETA ENERGÉTICA

A ++

TECHNICAL

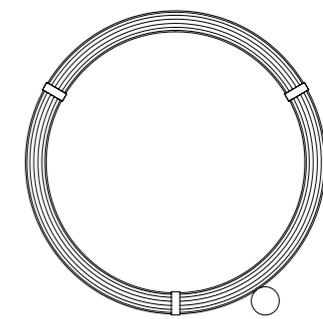

321

Ø1075

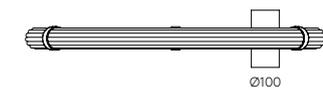

Ø100

250

BION

Floor lamp

P1306

Designed by Pepe Fornas, 2022

DESCRIPTION

MATERIALS

Steel / Marble

FINISHES

Body:
Matt black
Aged gold

Shade:
Matt black
Matt white

Base:
Mat black marble

SPECIFICATIONS (UE)

G9 LED 5W 2700K
Dimmable (Incluida)
Possibility to add
dimmer on cable
220-240 V, 50/60 Hz
IP20, Class II

ENERGY LABEL

A ++

IP20 CE 

MATERIALES

Acero / Mármol

ACABADOS

Cuerpo:
Negro mate
Oro envejecido

Tulipa:
Negro mate
Blanco mate

Base:
Mármol negro mate

ESPECIFICACIONES (UE)

G9 LED 5W 2700K
Regulable (Incluida)
Posibilidad de añadir
regulación en cable
220-240 V, 50/60 Hz
IP20, Clase II

ETIQUETA ENERGÉTICA

A ++

TECHNICAL

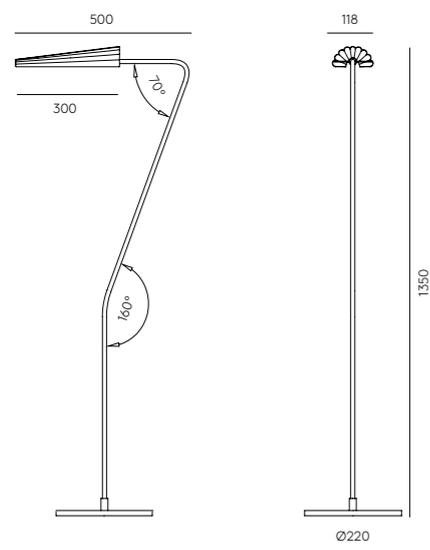

Lviv, Ukraine



FITO

Floor lamp

P1286

Designed by Pepe Fornas, 2020

DESCRIPTION

MATERIALS

Steel / Marble

FINISHES

Metal:
Matt black

Base:
Black Marble

Rack:
Matt Brass

RECOMMENDED BULB

T8/14W

SPECIFICATIONS (UE)

T8 Led 14W (Included)

3000K

220-240 V, 50/60 Hz

IP20, Class II

ENERGY LABEL

A ++



MATERIALES

Acero / Mármol

ACABADOS

Metal:
Negro Mate

Base:
Mármol Negro

Rejilla:
Oro Mate

BOMBILLA RECOMENDADA

T8/14W

ESPECIFICACIONES (UE)

T8 Led 14W (Incluido)

3000K

220-240 V, 50/60 Hz

IP20, Clase II

ETIQUETA ENERGÉTICA

A ++

TECHNICAL

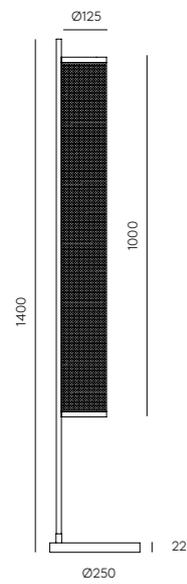

270



FOCUS

Floor lamp

P1279

Designed by Pepe Fornas, 2019

DESCRIPTION

MATERIALS

Steel / Aluminium

FINISHES

Body:
Matt black

Head:
Aged Gold
Anthracite

POSSIBLE MODIFICATIONS

Alabaster head extra cost

RECOMMENDED BULB

B161

SPECIFICATIONS (UE)

GU10 Led Bulb (Included)

5W - 3000K

220-240 V, 50/60 Hz

IP20, Class II

ENERGY LABEL

A ++



MATERIALES

Acero / Mármol

ACABADOS

Cuerpo:
Negro Mate

Cabeza:
Oro Viejo
Antracita

MODIFICACIONES POSIBLES

Cabezal de alabastro coste extra

BOMBILLA RECOMENDADA

B161

ESPECIFICACIONES (UE)

Bombilla GU10 Led (Incluida)

5W - 3000K

220-240 V, 50/60 Hz

IP20, Clase II

ETIQUETA ENERGÉTICA

A ++

TECHNICAL

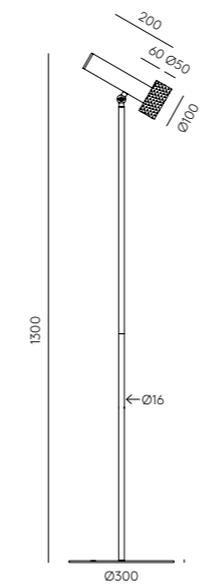

271

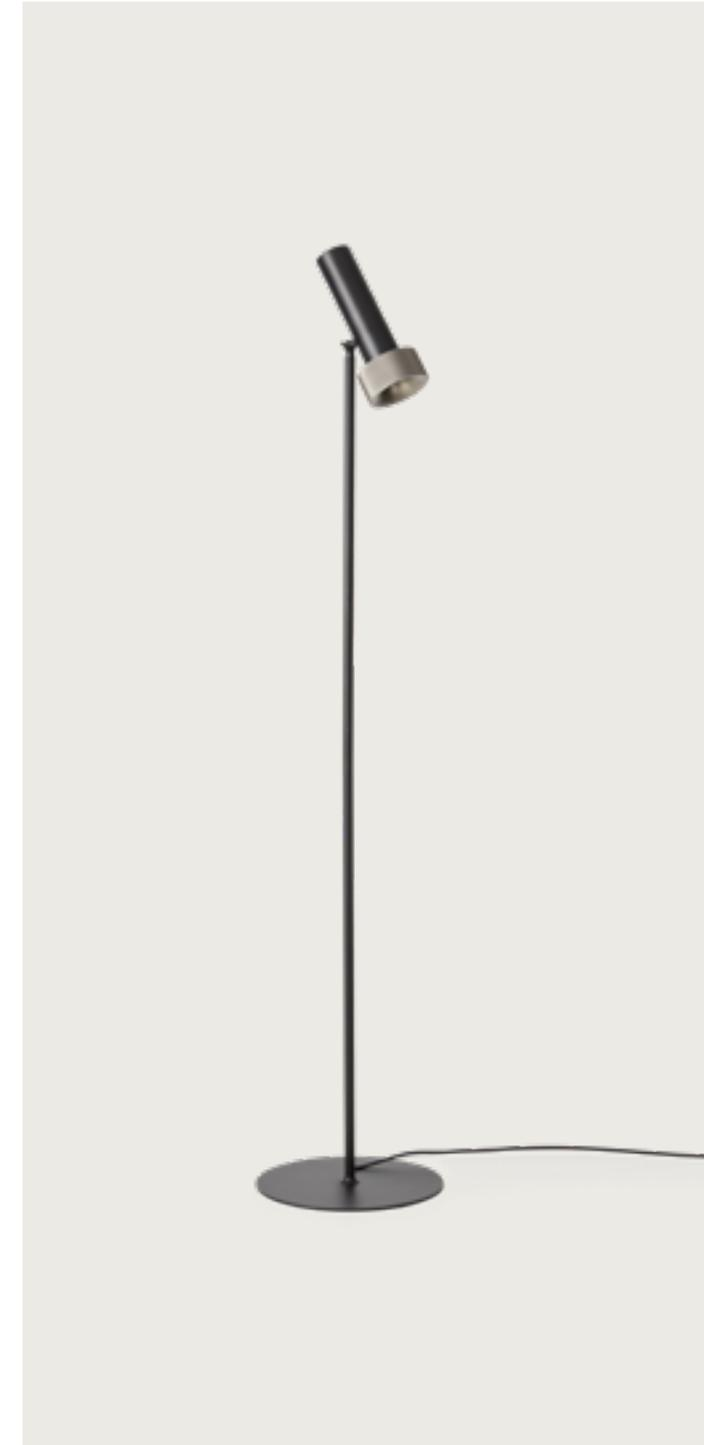

NOOI

Floor lamp

P1276

Designed by Pepe Fornas, 2022

DESCRIPTION

MATERIALS

Linen / Steel / Acrylic

FINISHES

Metal:
Matt Black

Shade:
Cream Linen textile

Acrylic:
Opal

SPECIFICATIONS (UE)

T8 14W - 3000K
Dimmer on cable
24V, 50/60Hz
IP20, Class II

ENERGY LABEL

A ++

IP20 CE   

MATERIALES

Lino / Metal / Acrílico

ACABADOS

Metal:
Negro mate

Tulipa:
Textil Lino Crema

Acrílico:
Opal

ESPECIFICACIONES (UE)

T8 14W - 3000K
Regulador en cable
24 V, 50/60 Hz
IP20, Clase II

ETIQUETA ENERGÉTICA

A ++

TECHNICAL

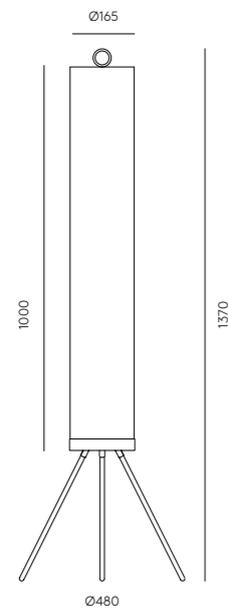

Cape Town, South Africa



LYB

Floor lamp

P1274

Designed by Pepe Fornas, 2019

DESCRIPTION

MATERIALS

Steel

FINISHES

Metal:
Matt black

TOUCH ME DIMMABLE

SPECIFICATIONS (UE)

Chip Led dimmable integrated
5W, 3000K
12 V, 50/60 Hz
IP20, Class II

ENERGY LABEL

A ++

IP20 CE RoHS WEEE A++

MATERIALES

Acero

ACABADOS

Metal:
Negro Mate

TOUCH ME REGULABLE

ESPECIFICACIONES (UE)

Chip Led regulable incluido 5W,
3000K
12 V, 50/60 Hz
IP20, Clase II

ETIQUETA ENERGÉTICA

A ++

TECHNICAL

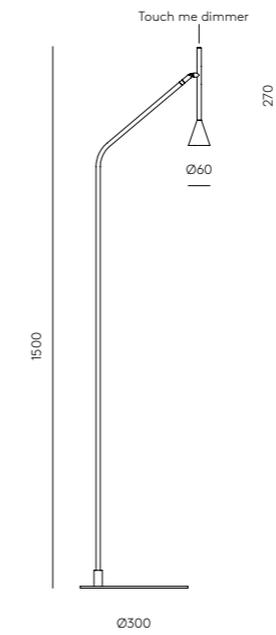

COLN

Floor lamp

P1267

Designed by AC Studio, 2019

DESCRIPTION

MATERIALS

Steel / Marble

FINISHES

Metal:
Matt Black

Marble:
Black

SPECIFICATIONS (UE)

Strip LED 21W 2700K
dimmer foot push on cable
24 V, 50/60 Hz, IP20, Class II

ENERGY LABEL

A ++

MATERIALES

Acero / Mármol

ACABADOS

Metal:
Negro mate

Mármol:
Negro

ESPECIFICACIONES (UE)

Tira LED 21W 2700K
Regulador en cable
24 V, 50/60 Hz, IP20, Clase II

ETIQUETA ENERGÉTICA

A ++

IP20 CE   

TECHNICAL

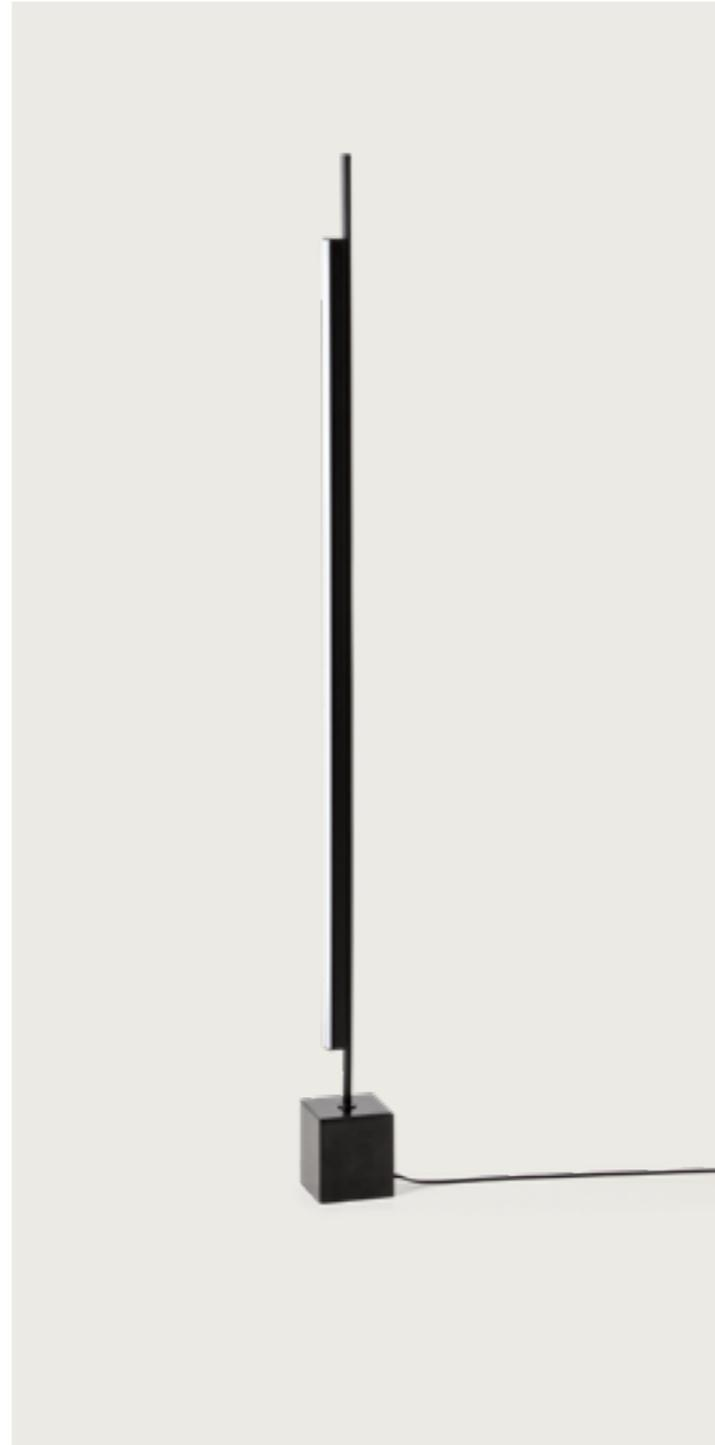
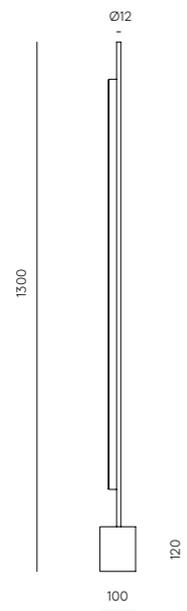

HINOO

Floor lamp

P1266

Designed by JF Sevilla, 2021

DESCRIPTION

MATERIALS

Steel / Marble / Acrylic

FINISHES

Body:
Black

Marble:
White

SPECIFICATIONS (UE)

Integrated Dimmable LED
13W 3000K, 9-21V, 50/60 Hz,
IP20, Class II
Dimmer foot switch on cable

ENERGY LABEL

A ++

MATERIALES

ACERO / MÁRMOL / ACRÍLICO

ACABADOS

Cuerpo:
Negro mate

Mármol:
Negro
Blanco

ESPECIFICACIONES (UE)

LED integrado Regulable
13W 3000K, 9-21V, 50/60 Hz,
IP20, Clase II
Interruptor y regulador en cable

ETIQUETA ENERGÉTICA

A ++

IP20 CE   

DESCRIPTION

MATERIALS

Steel / Marble / Acrylic

FINISHES

Body:
Black

Marble:
White

Black

DIMMER ON CABLE

SPECIFICATIONS (UE)

Integrated Dimmable LED
13W 3000K, 9-21V, 50/60 Hz,
IP20, Class II
Dimmer foot switch on cable

ENERGY LABEL

A ++

IP20 CE   

DESCRIPTION

MATERIALES

ACERO / MÁRMOL / ACRÍLICO

ACABADOS

Cuerpo:
Negro mate

Mármol:
Negro
Blanco

REGULADOR DE PIE EN CABLE

ESPECIFICACIONES (UE)

LED integrado Regulable
13W 3000K, 9-21V, 50/60 Hz,
IP20, Clase II
Interruptor y regulador en cable

ETIQUETA ENERGÉTICA

A ++

IP20 CE   

TECHNICAL

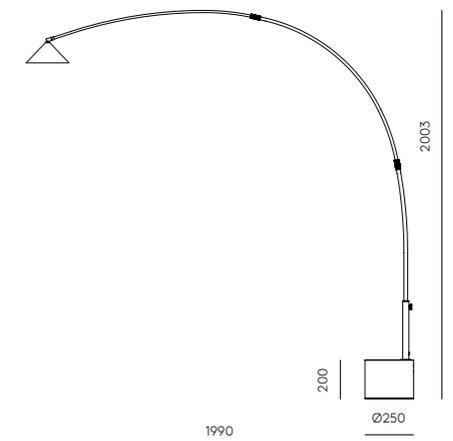

HINOO



Mallorca, Spain

ABBACUS

Floor lamp

P1258

Designed by Pepe Fornas, 2018

DESCRIPTION

MATERIALS

Steel / Blown Glass

FINISHES

Metal:
Gold

Glass Shade (Included):
Opal
Clear

RECOMMENDED BULB
B005/5W

SPECIFICATIONS (UE)

Bulb G9 (Included)
5W - 2700K
220-240 V, 50/60 Hz
IP20, Class II

ENERGY LABEL

A ++

IP20 CE RoHS A++

MATERIALES

Acero / Vidrio Soplado

ACABADOS

Metal:
Oro

Cristal (Incluido):
Opal
Transparente

BOMBILLA RECOMENDADA
B005/5W

ESPECIFICACIONES (UE)

Bombilla G9 (Incluida)
5W - 2700K
220-240 V, 50/60 Hz
IP20, Clase II

ETIQUETA ENERGÉTICA

A ++

TECHNICAL

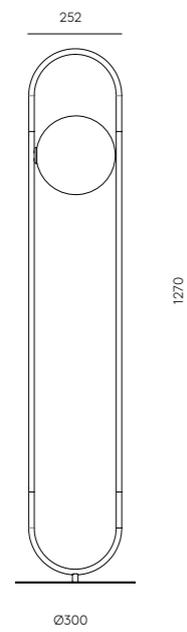

ARCTIC

Floor lamp

P1256

Designed by Pepe Fornas, 2020

DESCRIPTION

MATERIALS

Steel

FINISHES

Metal:
Matt Black

Lampholder:
Matt Brass

ACCESSORIES

Image reference accessory 1135
- 30, 60, 90 cm or 1134 - 30,50 or
70 cm (Not included)

Image colours:

1135/30 - Mustard / 1135/60 - Sil-
houette / 1135/90 - Green leaf

RECOMMENDED BULBS

B048 (G125)
B047 (G95)

SPECIFICATIONS (UE)

3 x E27 (Bulbs not included)
220-240 V, 50/60 Hz
IP20, Class II

ENERGY LABEL

A ++

IP20 CE RoHS A++

MATERIALES

Acero

ACABADOS

Metal:
Negro Mate

Portalámparas:
Oro Mate

ACCESORIOS

Accesorio imagen 1135 -
30, 60, 90 cm o 1134 - 30,50 o
70 cm (No incluido)

Image colours:

1135/30 - mostaza / 1135/60 -
silhouete / 1135/90 - verde hoja

BOMBILLAS RECOMENDADAS

B048 (G125)
B047 (G95)

ESPECIFICACIONES (UE)

3 x E27 (Bombillas no incluidas)
220-240 V, 50/60 Hz
IP20, Clase II

ETIQUETA ENERGÉTICA

A ++

TECHNICAL

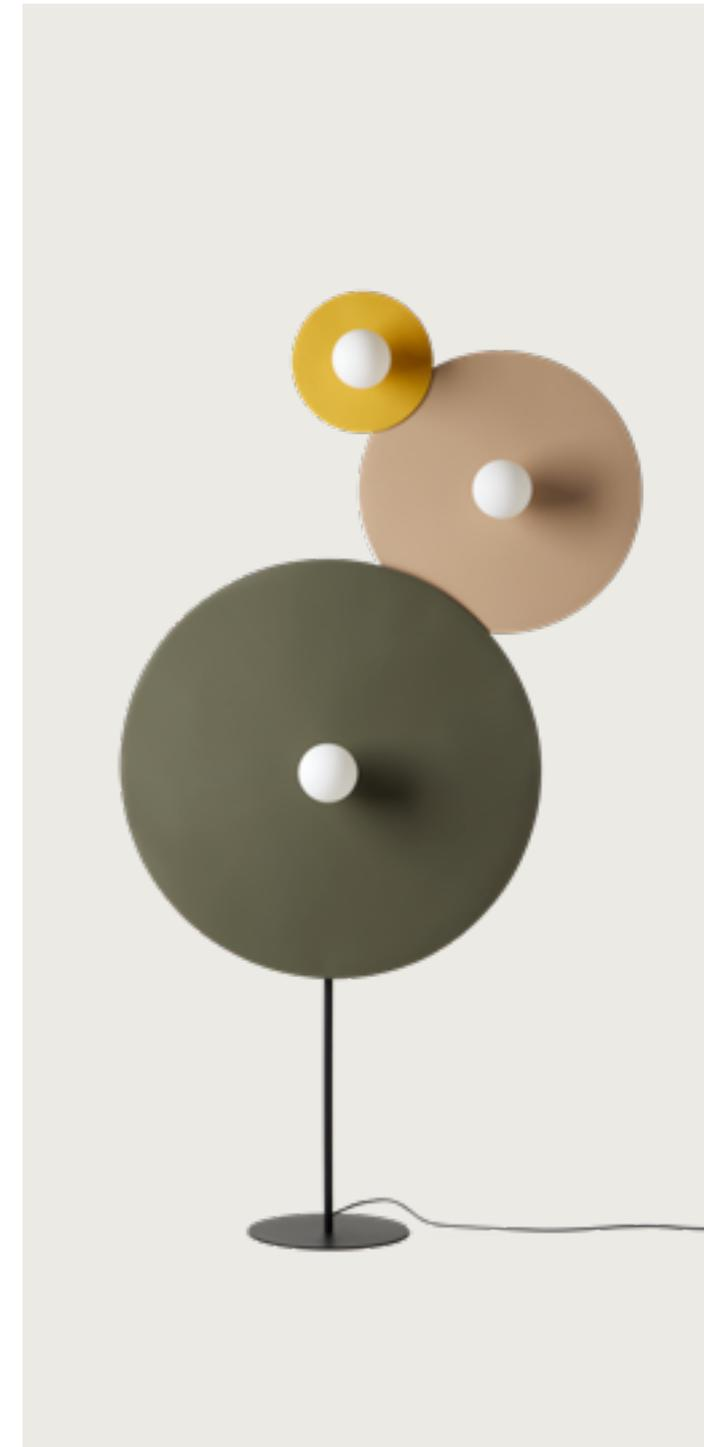
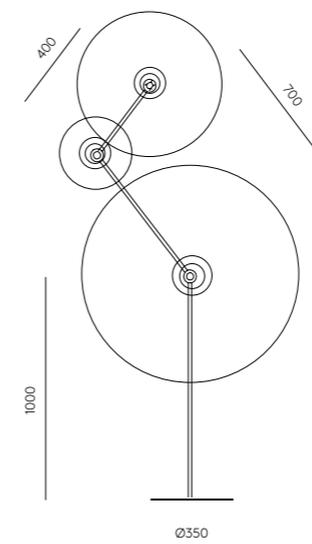

MAHO

Floor lamp

P1254

Designed by Pepe Fornas, 2021

DESCRIPTION

MATERIALS

Steel

FINISHES

Body:

Gold

Head:

Matt black

Matt Gold

SPECIFICATIONS (UE)

Chip LED 5W- 3000K.
220-240V, 50/60 Hz
IP20, Class I
Touch me dimmer on head

ENERGY LABEL

A ++

IP20 CE 

MATERIALES

Acero

ACABADOS

Cuerpo:

Negro mate

Cabezal:

Oro Mate

Negro Mate

ESPECIFICACIONES (UE)

Chip LED 5W- 3000K.
220-240V, 50/60 Hz
IP20, Clase I
Regulador Touch me en cabeza

ETIQUETA ENERGÉTICA

A ++

TECHNICAL

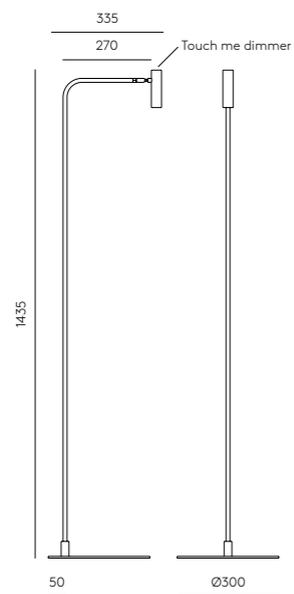

Ljubljana, Slovenia

COT

Floor lamp

P1251

Designed by AC Studio, 2018

DESCRIPTION

MATERIALS

Steel / Walnut Wood / Cotton

FINISHES

Wood:
Walnut
Shade:
Black
White

RECOMMENDED BULB

B211 (7, 9, 11W)

SPECIFICATIONS (UE)

E27 Max. 60W
(Not included)
220-240 V, 50/60 Hz
IP20, Class II

ENERGY LABEL

A ++

IP20 CE 

MATERIALES

Acero / Nogal / Algodón

ACABADOS

Madera:
Nogal
Pantalla:
Negra
Blanca

BOMBILLA RECOMENDADA

B211 (7, 9, 11W)

ESPECIFICACIONES (UE)

E27 Max. 60W
(No incluida)
220-240 V, 50/60 Hz
IP20, Clase II

ETIQUETA ENERGÉTICA

A ++

TECHNICAL

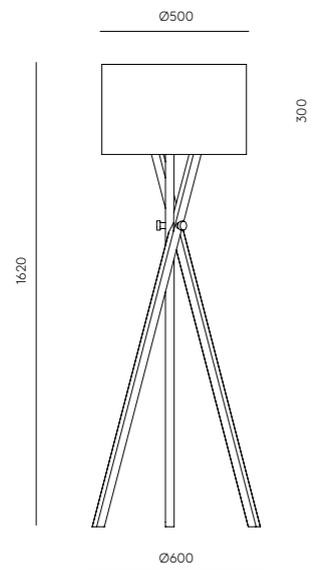

FICUS

Floor lamp

P1243

Designed by JF Sevilla, 2017

DESCRIPTION

MATERIALS

Steel

FINISHES

Metal:
Matt Black
Shade:
Matt Brass

RECOMMENDED BULB

B005/5W

SPECIFICATIONS (UE)

Bulb G9 (Included)
5W - 2700K
220-240 V, 50/60 Hz
IP20, Class II

ENERGY LABEL

A ++

IP20 CE 

MATERIALES

Acero

ACABADOS

Metal:
Negro Mate
Tulipa:
Oro Mate

BOMBILLA RECOMENDADA

B005/5W

ESPECIFICACIONES (UE)

Bombilla G9 (Incluida)
5W - 2700K
220-240 V, 50/60 Hz
IP20, Clase II

ETIQUETA ENERGÉTICA

A ++

TECHNICAL

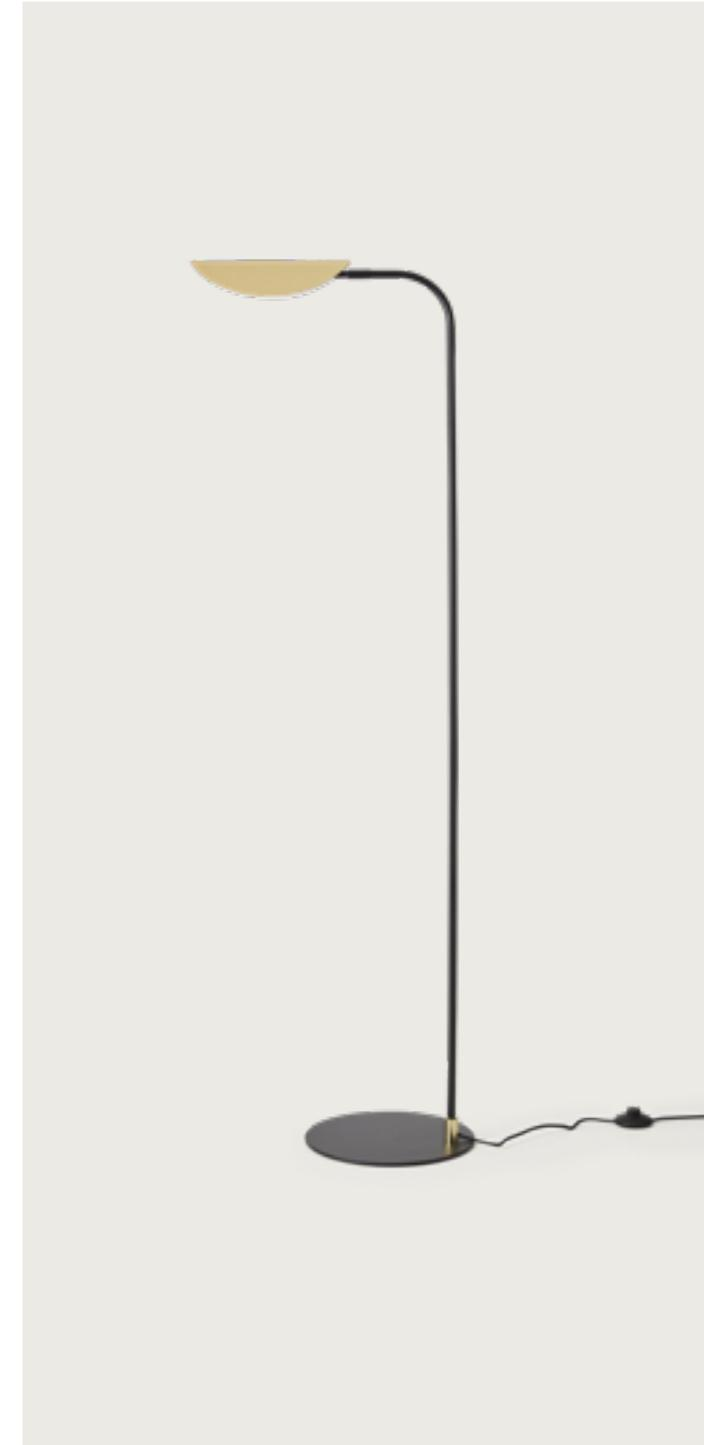
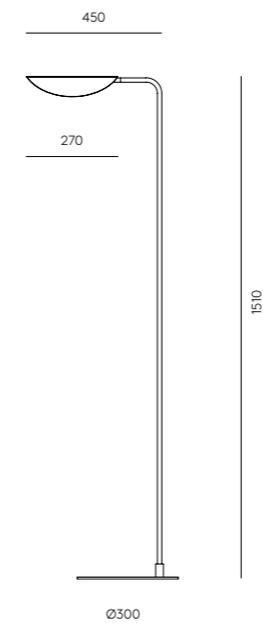

OHLALA

Floor lamp

P1242

Designed by AC Studio, 2018

DESCRIPTION

MATERIALS

Steel

FINISHES

Body:
Matt Black

Lampholders:
Matt Brass

ACCESSORIES

Accessories not included
Check on p. 362
Image Accessories 1023/20
Bulb B038

SPECIFICATIONS (UE)

2 x E27 Max. 60W
(Not included)
220-240 V, 50/60 Hz
IP20, Class II

ENERGY LABEL

A ++

IP20 CE    A++

MATERIALES

Acero

ACABADOS

Cuerpo:
Negro Mate

Portalámparas:
Oro

ACCESORIOS

Accesorios no incluidos
Consultar en pág. 362
Accesorios imagen 1023/20
Bombilla B038

ESPECIFICACIONES (UE)

Especificaciones (UE)
2 x E27 Max. 60W (No incluida)
220-240 V, 50/60 Hz
IP20, Clase II

ETIQUETA ENERGÉTICA

A ++

TECHNICAL

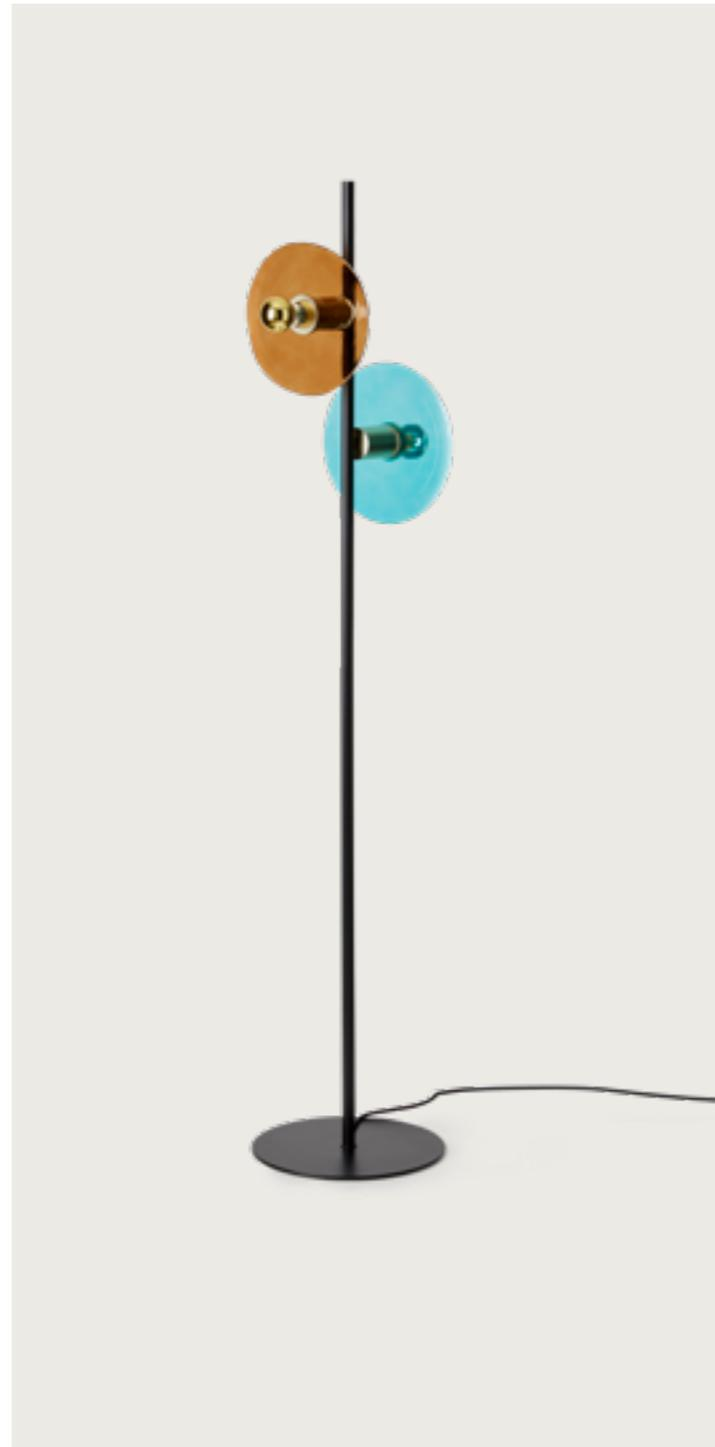
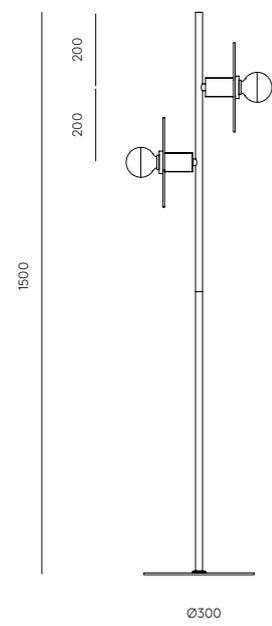

ARIO

Floor lamp

P1234

Designed by AC Studio, 2017

DESCRIPTION

MATERIALS

Steel / Cotton Shade

FINISHES

Metal:
Matt Black

Shade:
Black
Shade included

RECOMMENDED BULB

B211 (7, 9, 11W)

SPECIFICATIONS (UE)

E27 Max. 60W
(Not included)
220-240 V, 50/60 Hz
IP20, Class II

ENERGY LABEL

A ++

IP20 CE    A++

MATERIALES

Acero / Pantalla Algodón

ACABADOS

Metal:
Negro Mate

Pantalla:
Negra
Pantalla incluida

BOMBILLA RECOMENDADA

B211 (7, 9, 11W)

ESPECIFICACIONES (UE)

E27 Max. 60W
(No incluida)
220-240 V, 50/60 Hz
IP20, Clase II

ETIQUETA ENERGÉTICA

A ++

TECHNICAL

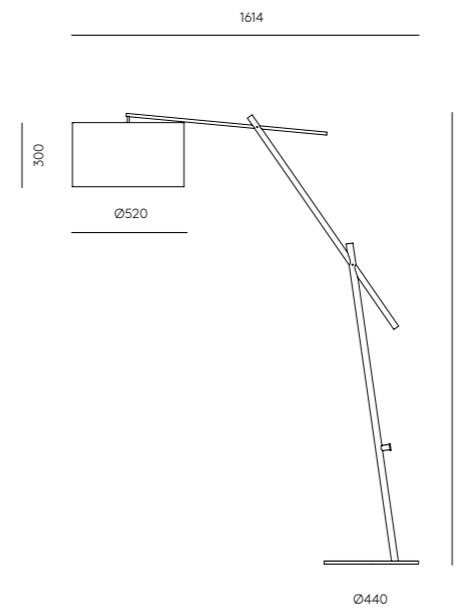

Tallin, Estonia



LUCA

Floor lamp

P1237

Designed by AC Studio, 2017

DESCRIPTION

MATERIALS

Steel / Marble

FINISHES

Metal:
Matt Black

Marble:
White

RECOMMENDED BULB

B211 (7, 9, 11W)

SPECIFICATIONS (UE)

E27 Max. 60W (Not included)
220-240 V, 50/60 Hz
IP20, Class II

ENERGY LABEL

A ++

IP20 CE    

MATERIALES

Acero / Mármol

ACABADOS

Metal:
Negro Mate

Mármol:
Blanco

BOMBILLA RECOMENDADA

B211 (7, 9, 11W)

ESPECIFICACIONES (UE)

E27 Max. 60W (No incluida)
220-240 V, 50/60 Hz
IP20, Clase II

ETIQUETA ENERGÉTICA

A ++

TECHNICAL

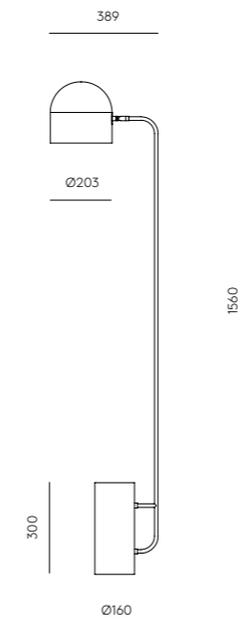

NERA

Floor lamp

P1229

Designed by Pepe Fornas, 2020

DESCRIPTION

MATERIALS

Steel / Wood / Acrylic

FINISHES

Metal:
Matt Black

Wood:
Matt Black

SPECIFICATIONS (UE)

LED COB integrated
8W 3000K (Included)
220-240 V, 50/60 Hz
Touch me - Dimmable

ENERGY LABEL

A ++



MATERIALES

Acero / Madera / Acrílico

ACABADOS

Metal:
Negro Mate

Madera:
Negro Mate

ESPECIFICACIONES (UE)

COB LED integrado
8W 3000K (Incluida)
220-240 V, 50/60 Hz
Touch me - Regulable

ETIQUETA ENERGÉTICA

A ++

TECHNICAL

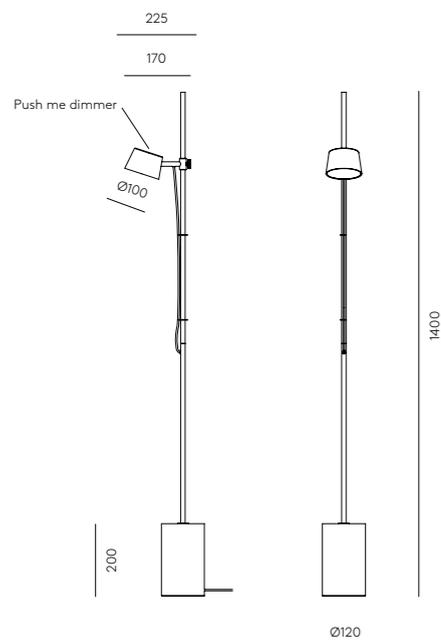

290



ATOM

Floor lamp

P1214

Designed by AC Studio, 2016

DESCRIPTION

MATERIALS

Steel / Blown Glass

FINISHES

Metal:
Matt Brass
Matt Black

Shade (Included):
Opal
Clear

RECOMMENDED BULB

B005/5W

SPECIFICATIONS (UE)

Bulb G9 (Included)
5W - 2700K
220-240 V, 50/60 Hz
IP20, Class II

ENERGY LABEL

A ++



MATERIALES

Acero / Vidrio Soplado

ACABADOS

Metal:
Oro Mate
Negro Mate

Cristal (Incluido):
Opal
Transparente

BOMBILLA RECOMENDADA

B005/5W

ESPECIFICACIONES (UE)

Bombilla G9 (Incluida)
5W - 2700K
220-240 V, 50/60 Hz
IP20, Clase II

ETIQUETA ENERGÉTICA

A ++

TECHNICAL

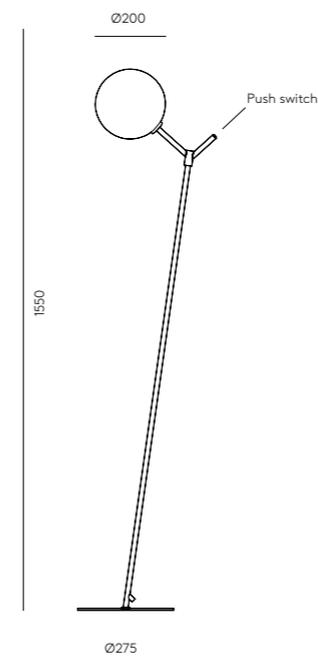

291

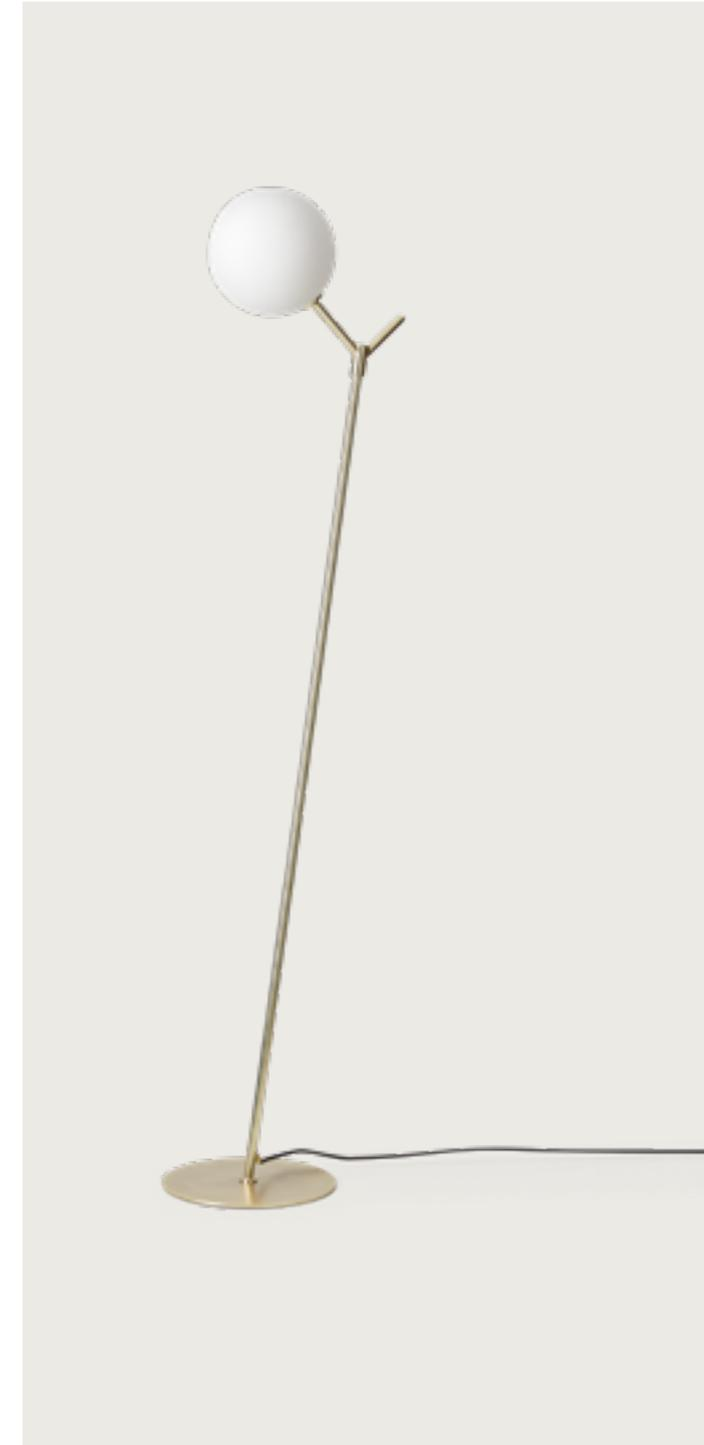

COHEN GOLD

Floor lamp

P1196

Designed by Jana Chang, 2010

DESCRIPTION

MATERIALS

Steel

FINISHES

COHEN - P1122

Metal:

Chrome

Shade:

Black

Shinny White

COHEN GOLD - P1196

Metal:

Matt Brass

Shade:

Black

Shinny White

RECOMMENDED BULB

B211 (7, 9, 11W)

SPECIFICATIONS (UE)

E27 Max. 60W (Not included)

220-240 V, 50/60 Hz

IP20, Class II

ENERGY LABEL

A ++



MATERIALES

Acero

ACABADOS

COHEN - P1122

Metal:

Cromo

Tulipa:

Negro

Blanco Brillo

COHEN GOLD - P1196

Metal:

Oro Mate

Tulipa:

Negro

Blanco Brillo

BOMBILLA RECOMENDADA

B211 (7, 9, 11W)

ESPECIFICACIONES (UE)

E27 Max. 60W (No incluida)

220-240 V, 50/60 Hz

IP20, Clase II

ETIQUETA ENERGÉTICA

A ++

TECHNICAL

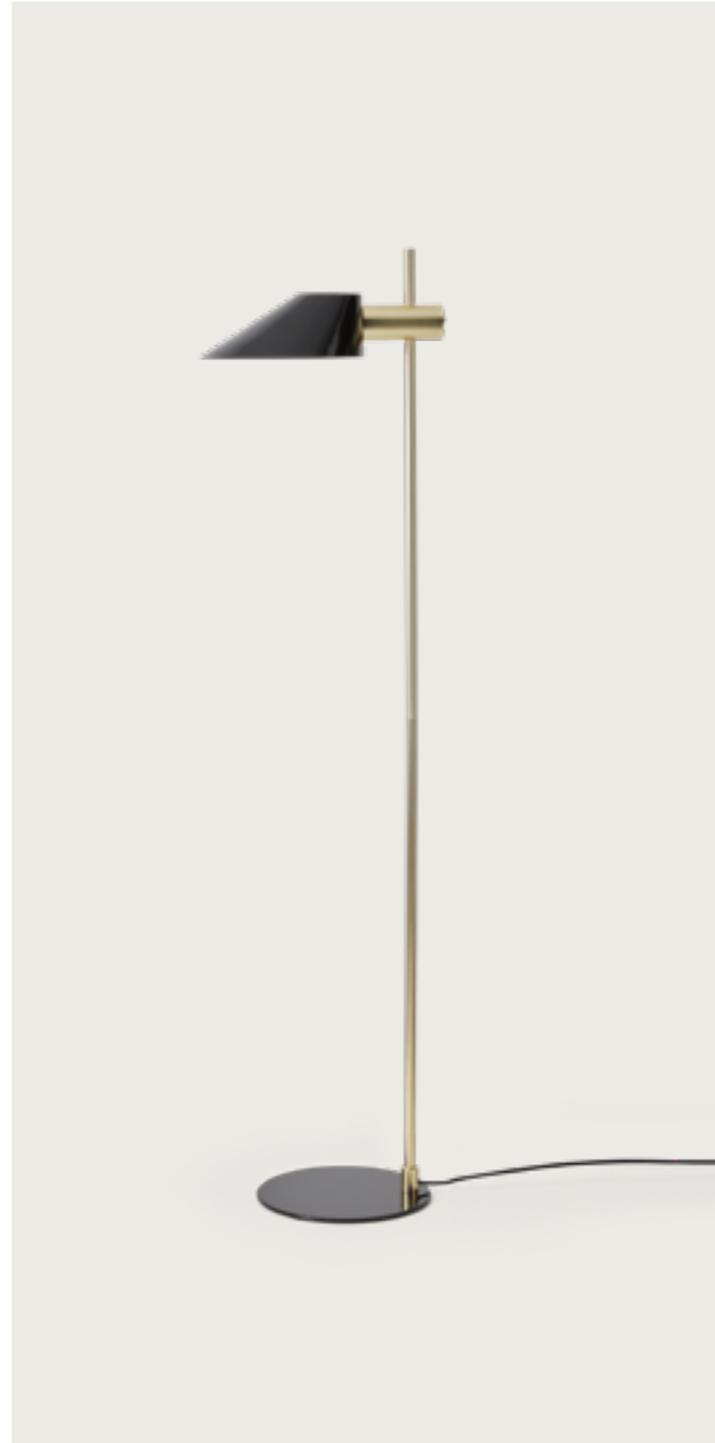
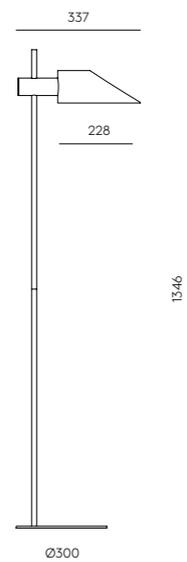

MARU

Floor lamp

P1194

Designed by JF Sevilla, 2015

DESCRIPTION

MATERIALS

Steel

FINISHES

Metal:

Matt Black - Matt Brass

Matt Black - Matt Black

SPECIFICATIONS (UE)

Integrated Chip Led

3W - 3150K

12 V, 50/60 Hz

IP20, Class II

ENERGY LABEL

A ++



MATERIALES

Acero

ACABADOS

Metal:

Negro Mate - Oro Mate

Negro Mate - Negro Mate

ESPECIFICACIONES (UE)

Chip Led integrado

3W - 3150K

12 V, 50/60 Hz

IP20, Clase II

ETIQUETA ENERGÉTICA

A ++

TECHNICAL

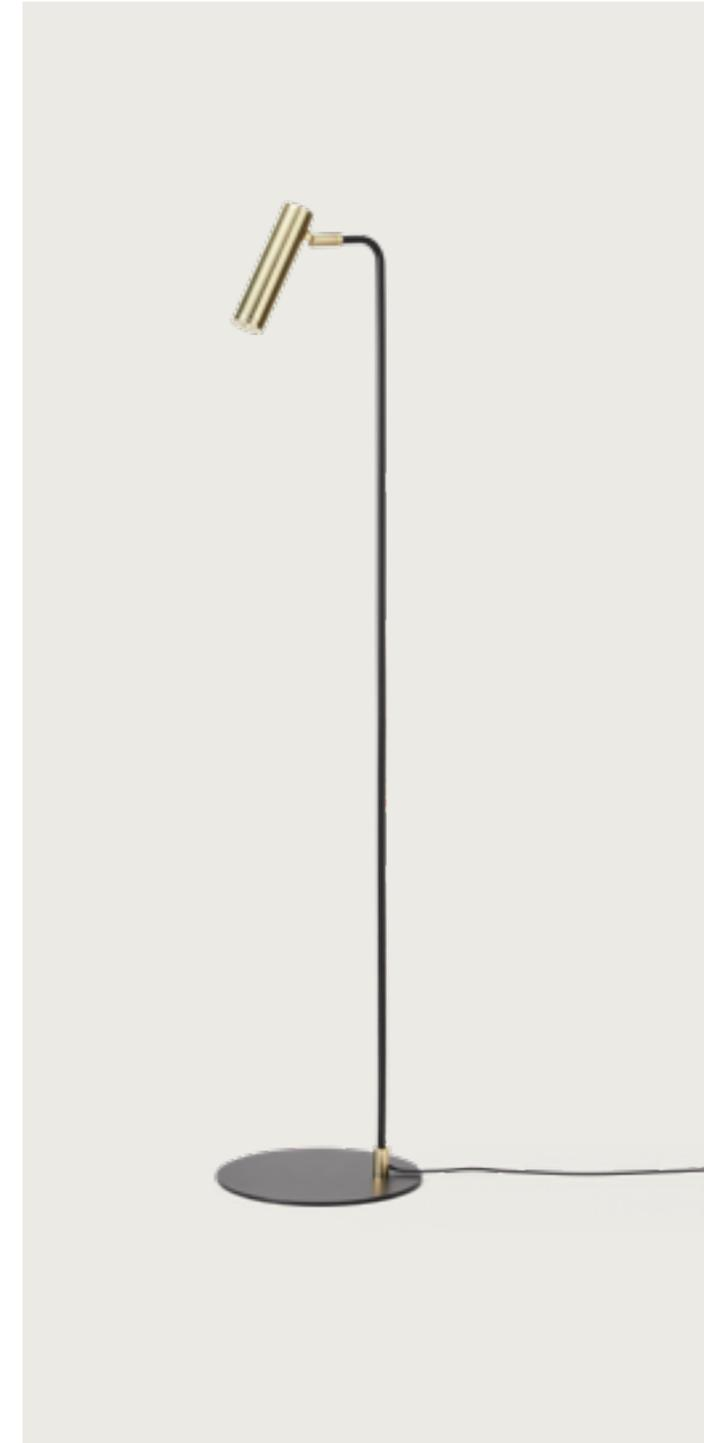
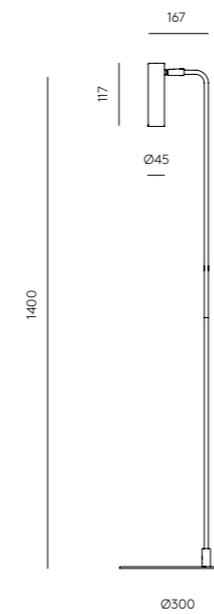

BOA

Floor lamp

P1193

Designed by Fornasevi, 2015

DESCRIPTION

MATERIALS

Steel

FINISHES

LUA - P1147

Metal:

Chrome

Shade:

Red

Black

Shinny White

LUA - P1147

Metal:

Matt Black

Shade:

Black

Matt Brass

RECOMMENDED BULB

B211 (7, 9, 11W)

SPECIFICATIONS (UE)

E27 Max. 60W (Not included)

220-240 V, 50/60 Hz

IP20, Class II

ENERGY LABEL

A ++



MATERIALES

Acero

ACABADOS

LUA - P1147

Metal:

Cromo

Tulipa:

Rojo

Negro

Blanco Brillo

LUA - P1147

Metal:

Negro Mate

Tulipa:

Negro

Oro Mate

BOMBILLA RECOMENDADA

B211 (7, 9, 11W)

ESPECIFICACIONES (UE)

E27 Max. 60W (No incluida)

220-240 V, 50/60 Hz

IP20, Clase II

ETIQUETA ENERGÉTICA

A ++

TECHNICAL

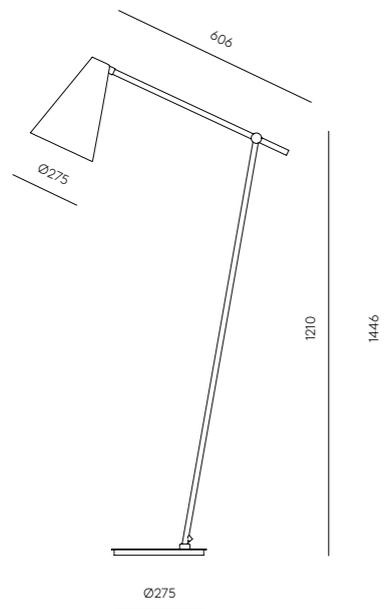

TRIPOD

Floor lamp

P1184

Designed by Estudio Cosí, 2014

DESCRIPTION

MATERIALS

Steel / Cotton Shade

FINISHES

Metal:

Matt Black

Shade:

Matt Black

RECOMMENDED BULB

B211 (7, 9, 11W)

SPECIFICATIONS (UE)

E27 Max. 60W (Not included)

220-240 V, 50/60 Hz

IP20, Class II

ENERGY LABEL

A ++



MATERIALES

Acero / Pantalla Algodón

ACABADOS

Metal:

Negro Mate

Pantalla:

Negro Mate

BOMBILLA RECOMENDADA

B211 (7, 9, 11W)

ESPECIFICACIONES (UE)

E27 Max. 60W (No incluida)

220-240 V, 50/60 Hz

IP20, Clase II

ETIQUETA ENERGÉTICA

A ++

TECHNICAL

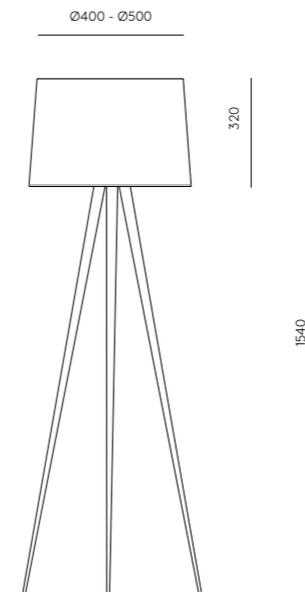

DODO

Floor lamp

P1169

Designed by Jana Chang, 2013

DESCRIPTION

MATERIALS

Steel

FINISHES

Metal:
Matt Black
Matt White

RECOMMENDED BULB

B211 (7, 9, 11W)

SPECIFICATIONS (UE)

E27 Max. 60W
(Not included)
220-240 V, 50/60 Hz
IP20, Class II

ENERGY LABEL

A ++



MATERIALES

Acero

ACABADOS

Metal:
Negro Mate
Blanco Mate

BOMBILLA RECOMENDADA

B211 (7, 9, 11W)

ESPECIFICACIONES (UE)

E27 Max. 60W
(No incluida)
220-240 V, 50/60 Hz
IP20, Clase II

ETIQUETA ENERGÉTICA

A ++

TECHNICAL

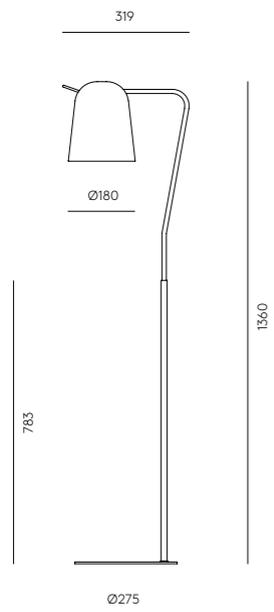

RIU

Floor lamp

P1140

Designed by JF Sevilla, 2012

DESCRIPTION

MATERIALS

Steel / Wood / Fabric / Acrylic

FINISHES

Metal:
Matt Black
Matt White

Wood:

Beech

Shade:

Black
White

RECOMMENDED BULB

B211 (7, 9, 11W)

SPECIFICATIONS (UE)

E27 Max. 60W (Not included)
220-240 V, 50/60 Hz
IP20, Class II

ENERGY LABEL

A ++



MATERIALES

Acero / Madera / Textil / Acrílico

ACABADOS

Metal:
Blanco mate
Negro Mate

Madera:

Haya

Pantalla:

Negro
Blanco

BOMBILLA RECOMENDADA

B211 (7, 9, 11W)

ESPECIFICACIONES (UE)

E27 Max. 60W (No incluida)
220-240 V, 50/60 Hz
IP20, Clase II

ETIQUETA ENERGÉTICA

A ++

TECHNICAL

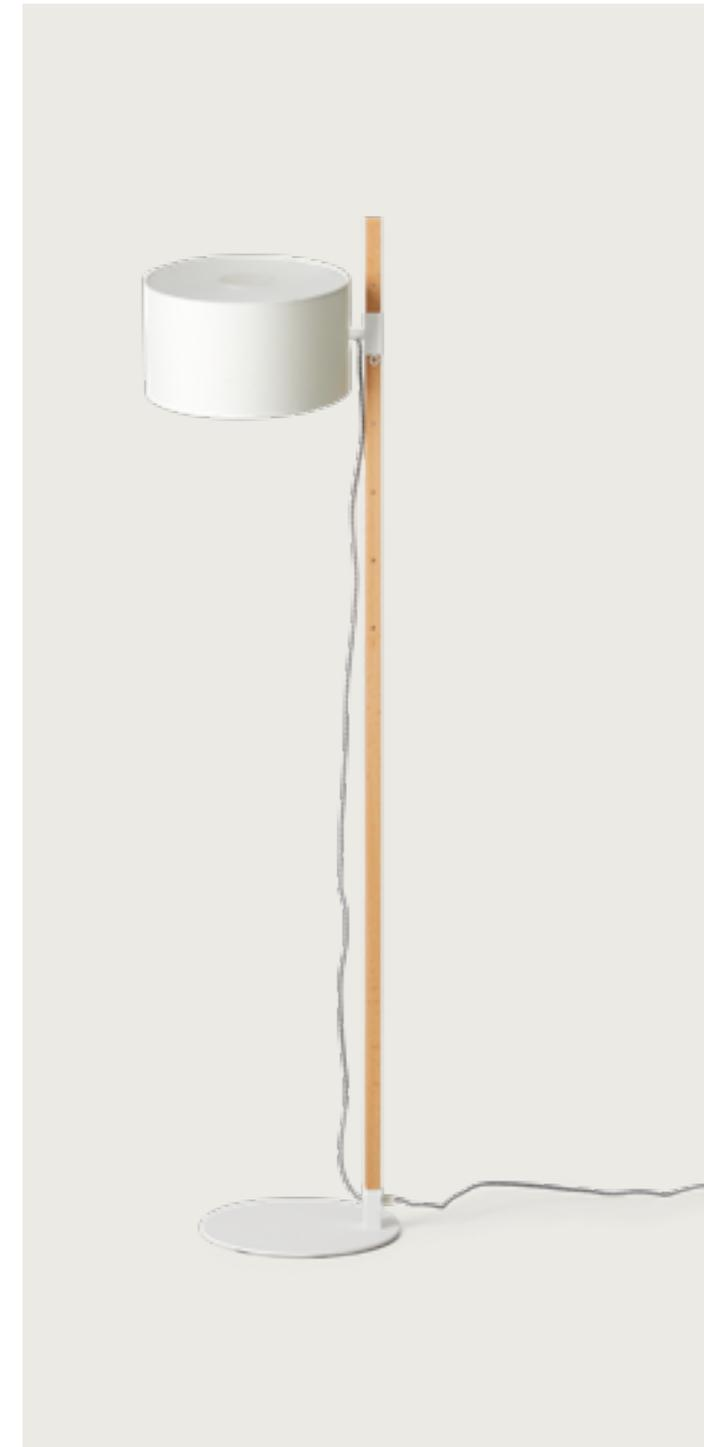
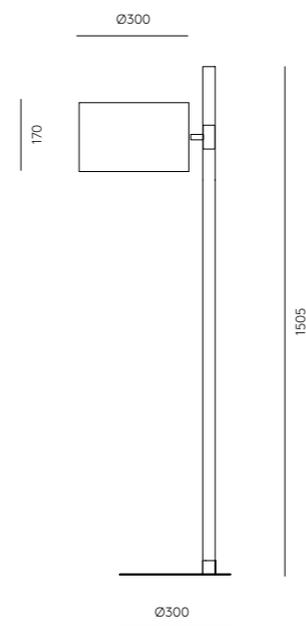

HEDRA

P1159

Designed by AC Studio, 2022

DESCRIPTION

MATERIALS

Steel / Marble

FINISHES

Metal:
Matt gold
Matt black

Marble:
Matt black

Image Shade:
(not included)
801011/41

RECOMMENDED BULB

B211 (7, 9, 11W)

SPECIFICATIONS (UE)

E27LED regulable 9W 3000K
(incluida), 220-240 V, 50/60 Hz
IP20, Clase II
Dimmer foot switch on cable

ENERGY LABEL

A ++

IP20 CE   

MATERIALES

Acero / Mármol

ACABADOS

Metal:
Oro mate
Negro mate

Mármol:
Negro mate

Pantalla en Imagen:
(no incluida)
801011/41

BOMBILLA RECOMENDADA

B211 (7, 9, 11W)

ESPECIFICACIONES (UE)

E27LED regulable 9W 3000K
(incluida) 230V, 50/60 Hz
IP20, Clase II
Interrupción y regulador en cable

ETIQUETA ENERGÉTICA

A ++

TECHNICAL

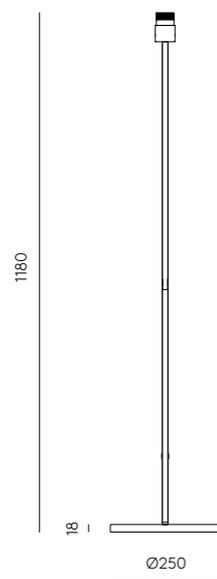



ENDO

Floor lamp

P1156

Designed by Pepe Fornas, 2013

DESCRIPTION

MATERIALS

Steel / Blown Glass

FINISHES

Metal:
Matt Brass
Chrome

Glass Shade (Included):
Opal

RECOMMENDED BULB
B005/5W

SPECIFICATIONS (UE)

Bulb G9 Led - 5W (Included)
2700K
220-240 V, 50/60 Hz
IP20, Class II

ENERGY LABEL

A ++



MATERIALES

Acero / Vidrio Soplado

ACABADOS

Metal:
Oro Mate
Cromo

Cristal (Incluido):
Opal

BOMBILLA RECOMENDADA
B005/5W

ESPECIFICACIONES (UE)

Bombilla G9 Led - 5W (Incluida)
2700K
220-240 V, 50/60 Hz
IP20, Clase II

ETIQUETA ENERGÉTICA

A ++

TECHNICAL

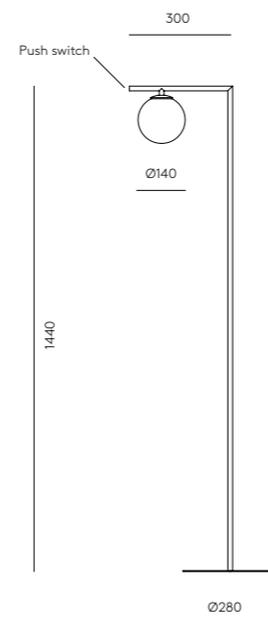

ONA

Floor lamp

P1029

Designed by JI Ballester, 2008

DESCRIPTION

MATERIALS

Steel / Smooth Fabric Shade

FINISHES

Metal:
Satin Nickel
Shade:
Black
White

RECOMMENDED BULB

B211 (7, 9, 11W)

SPECIFICATIONS (UE)

E27 - 2 x Max. 40W
(Not included)
220-240 V, 50/60 Hz
IP20, Class II

ENERGY LABEL

A ++



MATERIALES

Acero / Pantalla Textil Lisa

ACABADOS

Metal:
Níquel Satinado
Textil:
Negro
Blanco

BOMBILLA RECOMENDADA

B211 (7, 9, 11W)

ESPECIFICACIONES (UE)

E27 - 2 x Max. 40W
(No incluida)
220-240 V, 50/60 Hz
IP20, Clase II

ETIQUETA ENERGÉTICA

A ++

TECHNICAL

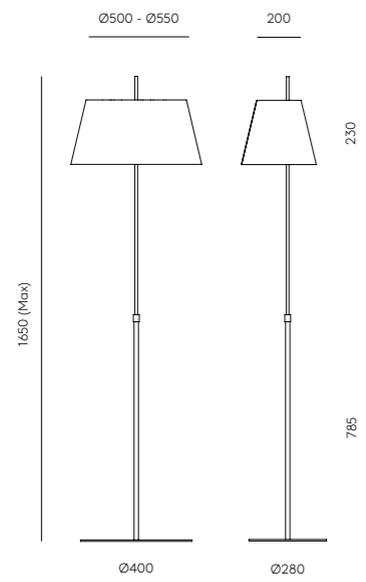

TEX

Floor lamp

P1026

Designed by AC Studio, 2012

DESCRIPTION

MATERIALS

Steel

FINISHES

Metal:
Matt White
Matt Black

IMAGE SHADE

(Not included)
151011/45

RECOMMENDED BULB

B211 (7, 9, 11W)

SPECIFICATIONS (UE)

E27 Max. 60W (Not included)
220-240 V, 50/60 Hz
IP20, Class II

ENERGY LABEL

A ++



MATERIALES

Acero

ACABADOS

Metal:
Blanco Mate
Negro Mate

PANTALLA EN IMAGEN

(No incluida)
151011/45

BOMBILLA RECOMENDADA

B211 (7, 9, 11W)

ESPECIFICACIONES (UE)

E27 Max. 60W (No incluida)
220-240 V, 50/60 Hz
IP20, Clase II

ETIQUETA ENERGÉTICA

A ++

TECHNICAL

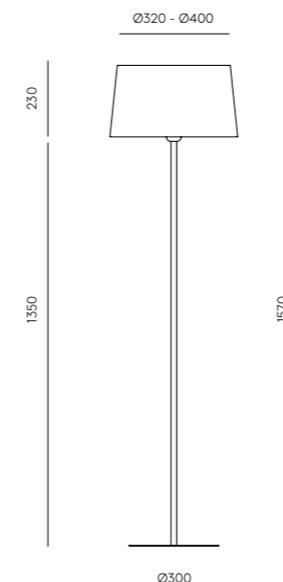



Wall

Lamps

- 306 **TURA** · A1313
- 308 **ELMA** · A1312
- 310 **DOUL** · A1310
- 312 **TANA** · A1309
- 314 **DUSSA** · A1307
- 316 **BION** · A1306
- 318 **ONETA** · A1299
- 319 **ISON** · A1298
- 320 **YCRO** · A1297
- 321 **PIPE** · A1293
- 322 **HAT** · A1291
- 324 **PORTA** · A1290
- 325 **MIRO** · A1289
- 326 **FITO** · A1286
- 327 **AMBOR** · A1283
- 328 **ATIL** · A1281
- 329 **DALT** · A1280
- 330 **FOCUS** · A1279
- 331 **NINO** · A1275
- 332 **NOOI** · A1276
- 334 **LYB** · A1274
- 335 **CLOCK** · A1273/120
- 336 **CLOCK** · A1273
- 338 **BOT** · A1272
- 339 **ALMON** · A1264
- 340 **XAGO** · A1262
- 342 **ABBY** · A1259/2
- 344 **ABBY** · A1259/4
- 345 **ABBY** · A1259/6
- 348 **ABBACUS** · A1258
- 349 **ERTO** · A1257
- 350 **SUAL** · A1255
- 351 **FLEXI LEATHER** · A1248
- 352 **MAHO** · A1254
- 354 **FICUS** · A1243
- 355 **LUCA** · A1237
- 356 **LITA** · A1230
- 357 **NERA** · A1229
- 358 **ALOA** · A1227
- 360 **DELIE** · A1224
- 361 **DELIE-L** · A1224/L
- 362 **HELMET** · A1221
- 363 **HELMET CURVE** · A1219
- 364 **LIND** · A1220
- 366 **ATOM** · A1214
- 367 **DOBI** · A1207
- 369 **COSS** · A1203
- 370 **BIGCOSS** · A1203/80
- 372 **MARU** · A1194
- 373 **LOTTO** · A1176/1175/1174
- 374 **DUO** · A1170/2
- 376 **CALP** · A1168
- 378 **IBRE** · A1162
- 379 **VENT** · A1161
- 380 **FLEXOR** · A1151
- 381 **PILD** · A1149
- 382 **AORA** · A1129
- 384 **OSION** · A1132
- 385 **ALTUN** · A1120
- 386 **FIND** · A1110
- 387 **READ** · A1106
- 388 **CROPI** · A1100/56/25
- 390 **RANG** · A1093
- 392 **VASTER** · A1092
- 393 **MINI ROSS** · A1063
- 394 **LASS** · A1053 + 1225
- 396 **FEST** · A1053 + 1223
- 397 **SPIDER** · A1053 + 1163
- 398 **LAOS** · A1053 + 1141
- 399 **FLAT** · A1053 + 1135
- 402 **TAN TAN** · A1053 + 1125
- 403 **KASSY** · A1053 + 1097
- 404 **WAVE** · A1053 + 1094/30
- 406 **ALBA** · A1053 + 1096
- 407 **LINE** · A1053 + 1089
- 408 **HABAN** · A1053 + 1088
- 409 **GHABAN** · A1053 + R1086/1086

TURA

A1313

Designed by JF Sevilla, 2023

DESCRIPTION

MATERIALS

Steel / Leather

FINISHES

Metal:

Matt black

Leather:

Black / Brown / Orange

SPECIFICATIONS

LED chip 5W 2700K

24V, 50/60Hz

IP20, Class I

ENERGY LABEL

A ++



MATERIALES

Metal / Cuero

ACABADOS

Metal:

Negro mate

Cuero:

Negro / Marrón / Naranja

ESPECIFICACIONES

Chip LED 5W 2700K

24V, 50/60 Hz

IP20, Clase I

ETIQUETA ENERGÉTICA

A ++

TECHNICAL

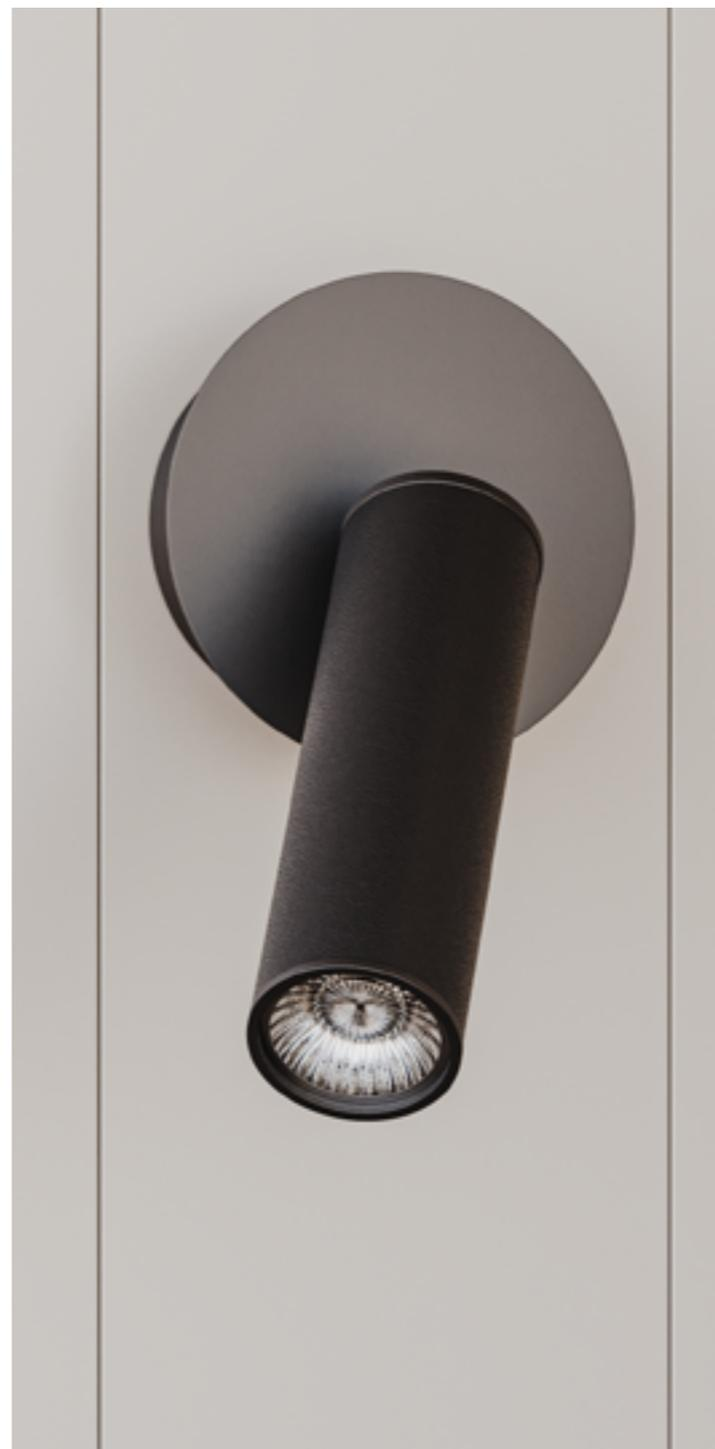
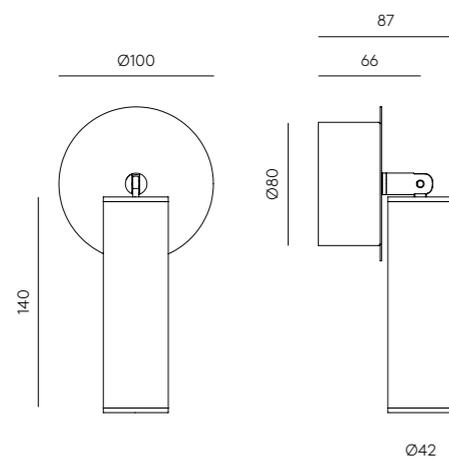

Buenos Aires, Argentina



Stockholm, Sweden



ELMA

Wall lamp

A1312

Designed by Jose Fornas, 2023

DESCRIPTION

MATERIALS

Metal / Glass / Acrylic

FINISHES

Metal: Matte Black / Antique Gold

Glass: Striped glass - Transparent

Acrylic - Opal

SPECIFICATIONS

LED strip 6W 2700K TRIAC dim-
mable

24V, 50/60Hz

IP44, Class I

ENERGY LABEL

A ++

MATERIALES

Metal / Vidrio / Acrílico

ACABADOS

Metal: Negro mate / Oro

envejecido

Cristal:

Cristal estriado - Transparente

Acrílico - Opal

ESPECIFICACIONES

Tira LED 6W 2700K TRIAC

regulable

24V, 50/60 Hz

IP, Clase I

ETIQUETA ENERGÉTICA

A ++

⊕ IP20 CE    

TECHNICAL

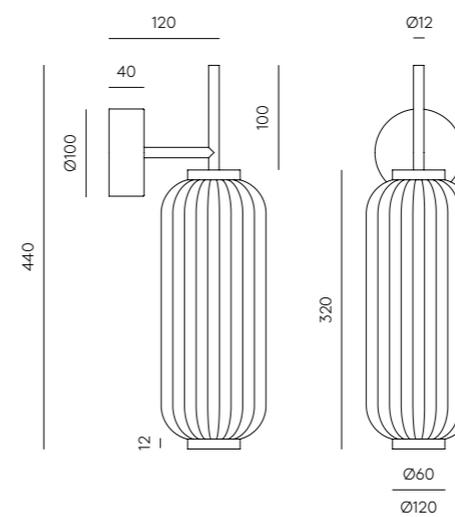

DOUL

A1310

Designed by Agus Gascón, 2023

DESCRIPTION

MATERIALS
Steel / Glass

FINISHES

Metal:
Matt black / Matt Brass

Glass:
Striped glass - Transparent

SPECIFICATIONS (UE)

G4 LEDs 3W 2700K
Adjustable (Included)
Regulation on cable
220-240V, 50/60Hz
IP44, Class I

ENERGY LABEL

A++

IP20 CE    

MATERIALES
Acero / Vidrio

ACABADOS

Metal: Negro mate / Oro envejecido

Cristal: Cristal rayado - Transparente

ESPECIFICACIONES (UE)

G4 LED 3W 2700K
Regulable (Incluida)
Regulación en cable
220-240 V, 50/60 Hz
IP44, Clase I

ETIQUETA ENERGÉTICA

A++

TECHNICAL

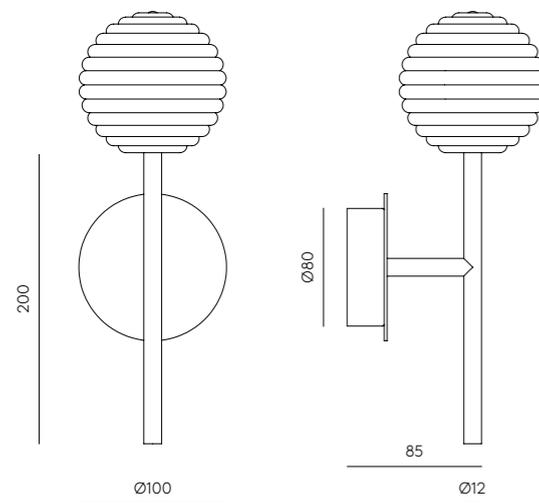

TANA

Wall lamp

A1309

Designed by JF Sevilla, 2022

DESCRIPTION

MATERIALS

Steel

FINISHES

Body:
Matt black

SPECIFICATIONS (UE)

Chip LED 4W - 2700K (Incluida)
Touch me Dimmer
220-240V - 24V - 50/60 Hz
IP20 - Class I

ENERGY LABEL

A ++

MATERIALES

Acero

ACABADOS

Cuerpo:
Negro mate

ESPECIFICACIONES (UE)

Chip LED 4W - 2700K (Incluida)
Regulador Touch me
220-240V - 24V - 50/60 Hz
IP20 - Clase I

ETIQUETA ENERGÉTICA

A ++

⊕ IP20 CE   

TECHNICAL

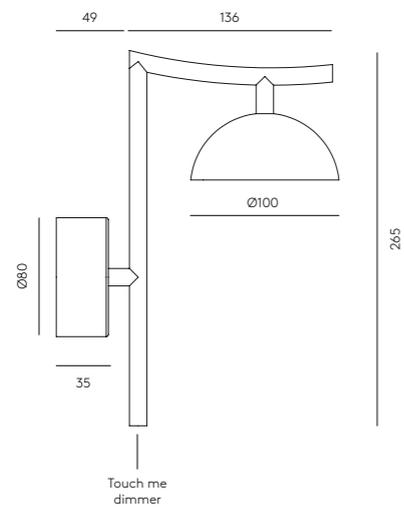

Barcelona, Spain

DUSSA

Wall lamp

A1307

Designed by Pepe Fornas, 2022

DESCRIPTION

MATERIALS

Steel / Marble

FINISHES

Steel:
Matt black
Matt Brass

Marble:

Black
White
Travertine

SPECIFICATIONS (UE)

Led Plate 9W 2700K
Dimmer Dali-Push driver
24 V, 50/60 Hz
IP20 - Class II

ENERGY LABEL

A ++

MATERIALES

Acero / Mármol

ACABADOS

Acero:
Negro mate
Oro envejecido

Mármol:

Negro
Blanco
Travertino

ESPECIFICACIONES (UE)

Placa LED 9W - 2700K
Regulador por Dali-Push
24 V, 50/60 Hz
IP20, Clase II

ETIQUETA ENERGÉTICA

A ++

IP20 CE RoHS A++

TECHNICAL

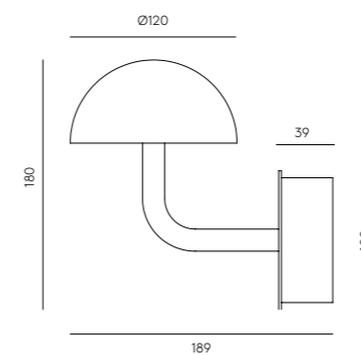

BION

Wall lamp

A1306

Designed by Pepe Fornas, 2022

DESCRIPTION

MATERIALS

Steel

FINISHES

Body:
Matt black
Matt Brass

Shade:

Matt black
Matt white

SPECIFICATIONS (UE)

G9 LED 5W 2700K
Dimmable (Included)
Possibility to add a dimmer inter-
face DALI/PUSH (DALI/230V)
220-240 V, 50/60 Hz
IP20, Class I

ENERGY LABEL

A ++

IP20 CE    

MATERIALES

Acero

ACABADOS

Cuerpo:
Negro mate
Oro envejecido

Tulipa:

Negro mate
Blanco mate

ESPECIFICACIONES (UE)

G9 LED 5W 2700K
Regulable (Incluida)
Posibilidad de añadir interfaz de
regulación DALI/PUSH (DALI/230V)
220-240 V, 50/60 Hz
IP20, Clase I

ETIQUETA ENERGÉTICA

A ++

TECHNICAL

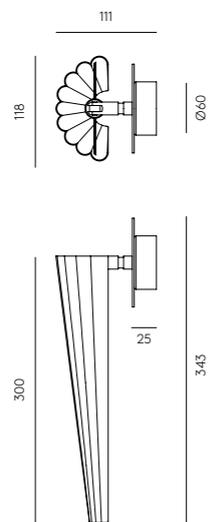

Prague, Czechia



ONETA

Wall lamp

A1299

Designed by JF Sevilla, 2022

DESCRIPTION

MATERIALS

Steel / Marble / Glass

FINISHES

Metal:
Matt Black
Aged gold

Marble:

White
Black
(Green marble option - extracost)

Glass:

Opal

SPECIFICATIONS (UE)

G4 LED 3W 2700K (included)
220-240 V - 50/60 Hz
Class I - IP20
Touch me dimmer on end of tube

ENERGY LABEL

A ++

⊕ IP20 CE 

MATERIALES

Acero / Mármol / Vidrio

ACABADOS

Metal:
Negro Mate
Oro envejecido

Mármol:

Blanco
Negro
(Opción mármol verde - sobrecoste)

Vidrio:

Opal

ESPECIFICACIONES (UE)

G4 LED 3W 2700K (incluida) 220-240 V - 50/60 Hz
Clase I - IP20
Regulador Touch me en el tubo

ETIQUETA ENERGÉTICA

A ++

TECHNICAL

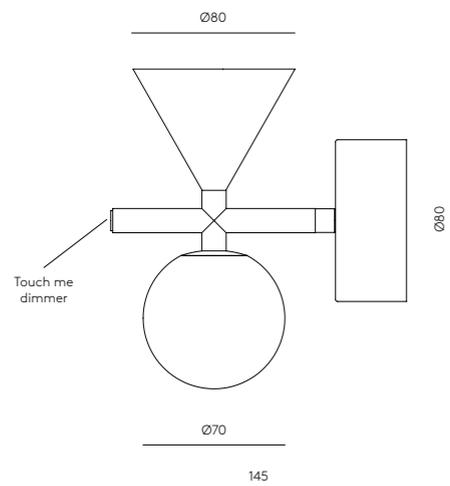

318

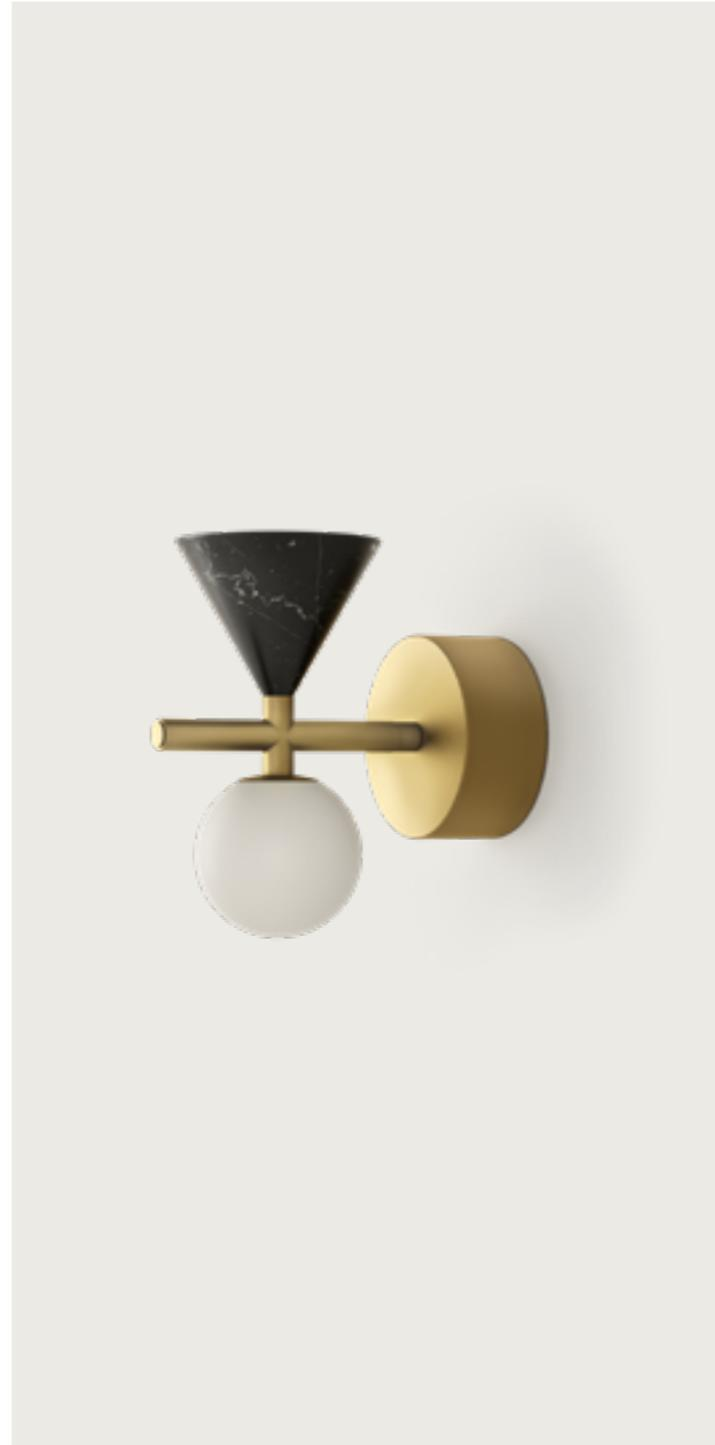

ISON

Wall lamp

A1298

Designed by Pepe Fornas, 2021

DESCRIPTION

MATERIALS

Steel / Glass

FINISHES

Steel:
Matt Brass
Matt Black

Glass:

Fluted glass

SPECIFICATIONS (UE)

LED Strip 6W - 2700K
TRIAC Dimmable
220-240V - 50/60 Hz
IP20 - Class I

ENERGY LABEL

A ++

⊕ IP20 CE 

MATERIALES

Acero / Vidrio

ACABADOS

Acero:
Oro Mate
Negro Mate

Vidrio:

Estriado

ESPECIFICACIONES (UE)

Tira LED 6W - 2700K
TRIAC Regulable
220-240V - 50/60 Hz
IP20 - Clase I

ETIQUETA ENERGÉTICA

A ++

TECHNICAL

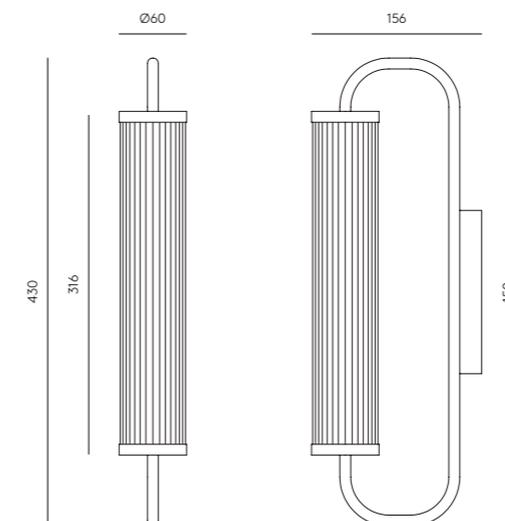

319



YCRO

Wall lamp

A1297

Designed by JF Sevilla, 2022



DESCRIPTION

MATERIALS

Steel

FINISHES

Metal:
Matt Black
Matt Brass

SPECIFICATIONS (UE)

Chip LED 8W 3000K
220-240 V - 50/60 Hz
Class I - IP20
Touch me dimmer on head

ENERGY LABEL

A ++



MATERIALES

Acero

ACABADOS

Metal:
Negro Mate
Oro Mate

ESPECIFICACIONES (UE)

Chip LED 8W 3000K
220-240 V - 50/60 Hz
Clase I - IP20
Regulador Touch me en cabeza

ETIQUETA ENERGÉTICA

A ++

TECHNICAL

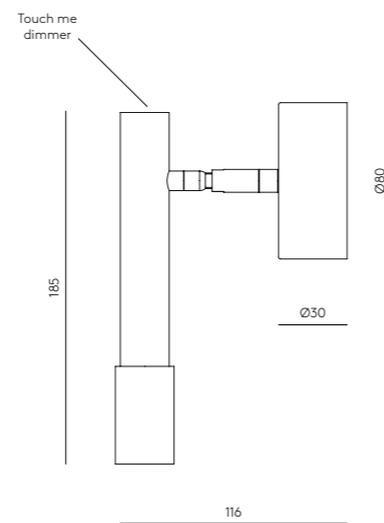

PIPE

Wall lamp

A1293

Designed by AC Studio, 2021



DESCRIPTION

MATERIALS

Steel

FINISHES

Metal:
Matt Black

SPECIFICATIONS (UE)

GU10 LED 3W 3000K (included)
230V, 50/60 Hz
IP20, Class I

ENERGY LABEL

A ++



MATERIALES

Acero

ACABADOS

Metal:
Negro Mate

ESPECIFICACIONES (UE)

GU10 LED 3W 3000K (incluida)
230V, 50/60 Hz
IP20, Clase I

ETIQUETA ENERGÉTICA

A ++

TECHNICAL

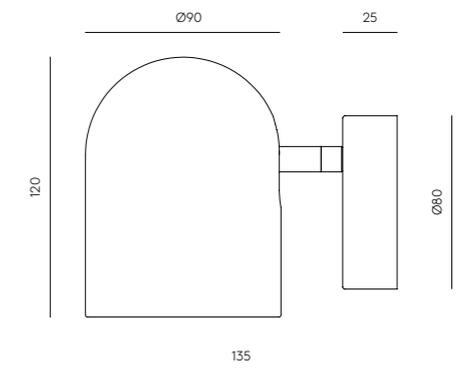



HAT

Wall lamp

A1291

Designed by Pepe Fornas, 2021

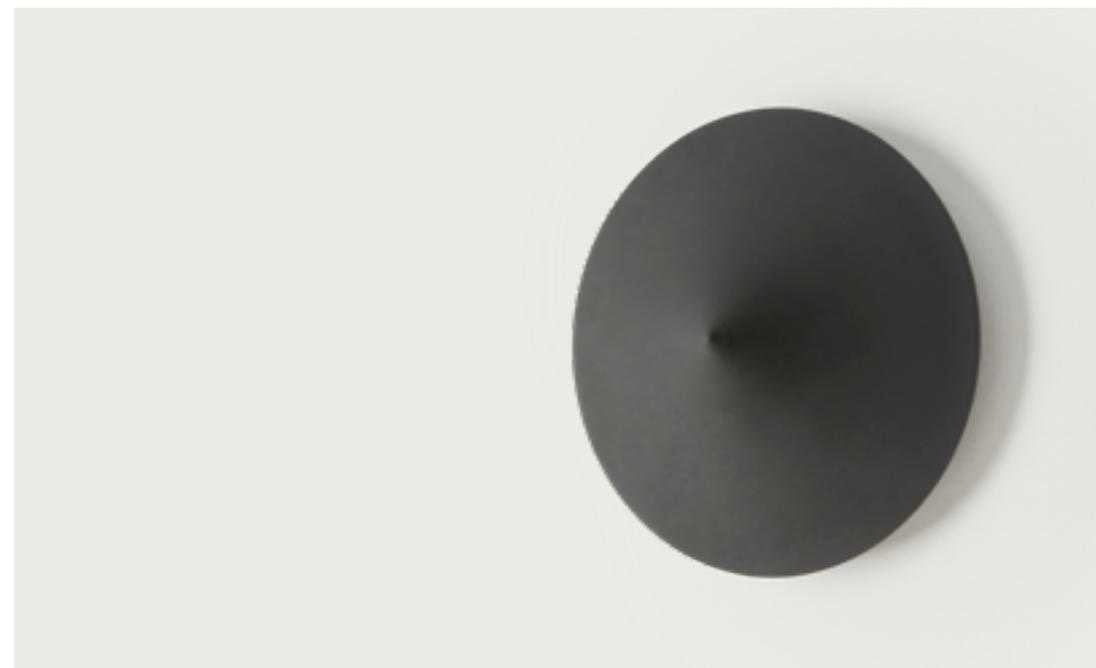

DESCRIPTION

MATERIALS

Steel

FINISHES

Metal:
Textured matt black
Textured matt white
Matt brass

SPECIFICATIONS (UE)

3 x G9 LED 5W 2700K
(Included)
24 V, 50/60 Hz,
IP20, Class I

ENERGY LABEL

A ++

⊕ IP20 CE   

MATERIALES

Acero

ACABADOS

Metal:
Oro mate
Negro mate texturizado
Blanco mate texturizado

ESPECIFICACIONES (UE)

3 x G9 LED 5W 2700K
(Included)
24 V, 50/60 Hz,
IP20, Clase I

ETIQUETA ENERGÉTICA

A ++

TECHNICAL

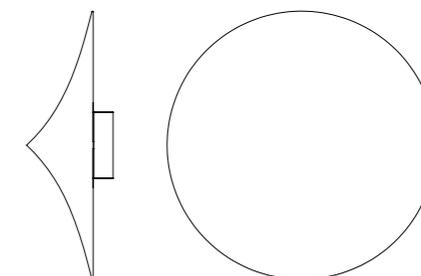

140

Ø400

PORTA

Wall lamp

A1290

Designed by Estudi Hac, 2021



DESCRIPTION

MATERIALS

Steel / Glass

FINISHES

Metal:
Matt Black

Glass:
Smoked grey

SPECIFICATIONS (UE)

9W LED plate - 3000K
Dimmable
220-240 V - 24V, 50/60 Hz,
IP20, Class I

ENERGY LABEL

A ++



MATERIALES

Acero / Vidrio

ACABADOS

Metal:
Negro Mate

Vidrio:
Fumé gris

ESPECIFICACIONES (UE)

Placa LED 9W - 3000K
Regulable
220-240 V - 24V, 50/60 Hz,
IP20, Clase I

ETIQUETA ENERGÉTICA

A ++

TECHNICAL

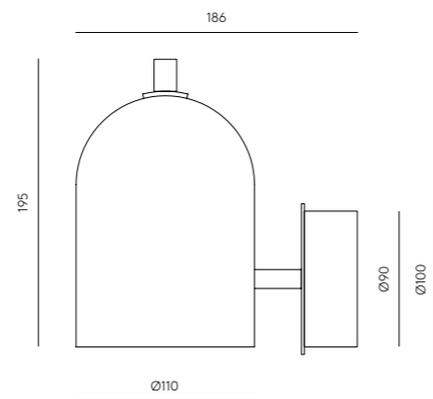

MIRO

Wall lamp

A1289

Designed by AC Studio, 2021



DESCRIPTION

MATERIALS

Steel / Blown Glass

FINISHES

Metal:
Matt black

Shade:
Opal

COMPATIBLE ACCESSORIES (NOT INCLUDED)

Alabaster 1096 (20 cm)
Ceramic 1097/20 (20 cm)
Metalic disc 1289/20 (15 cm)

RECOMMENDED BULB

B005/5W
SPECIFICATIONS (UE)
G9 LED (included) 5W 2700K
220-240V, 50/60 Hz
IP20, Class I

ENERGY LABEL

A ++



MATERIALES

Acero / Vidrio Soplado

ACABADOS

Metal:
Negro mate

Tulipa:
Opal

ACCESORIOS COMPATIBLES (NO INCLUIDOS)

Alabastro 1096 (20 cm)
Cerámica 1097/20 (20 cm)
Disco Metálico 1289/20 (15 cm)

BOMBILLA RECOMENDADA

B005/5W
ESPECIFICACIONES (UE)
G9 LED (incluida) 5W 2700K
220-240V, 50/60 Hz
IP20, Clase I

ETIQUETA ENERGÉTICA

A ++

TECHNICAL

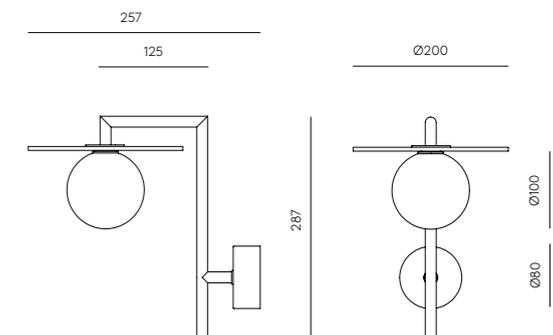

FITO

Wall lamp

A1286

Designed by Pepe Fornas, 2020

DESCRIPTION

MATERIALS

Steel / Marble

FINISHES

Metal: Matt Black

Base: Black Marble

Rack: Matt Brass

RECOMMENDED BULB

T8/14W

SPECIFICATIONS (UE)

T8 Led 14W (Included)
3000K, 220-240 V, 50/60 Hz
IP20, Class II

ENERGY LABEL

A ++

IP20 CE   

MATERIALES

Acero / Mármol

ACABADOS

Metal: Negro Mate

Base: Mármol Negro

Rejilla: Oro Mate

BOMBILLA RECOMENDADA

T8/14W

ESPECIFICACIONES (UE)

T8 Led 14W (Incluido)
3000K, 220-240 V, 50/60 Hz
IP20, Clase II

ETIQUETA ENERGÉTICA

A ++

TECHNICAL

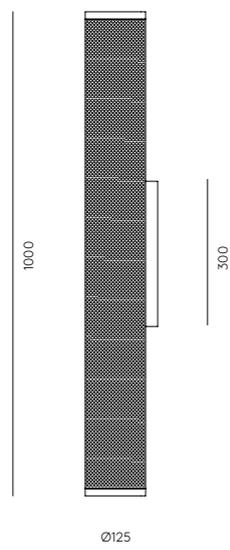

326



AMBOR

Wall lamp

A1283

Designed by Pepe Fornas, 2019

DESCRIPTION

MATERIALS

Steel / Acrylic Glass

FINISHES

Metal:

Matt Black

Matt Brass

Diffuser:

Opal

RECOMMENDED BULB

B005

SPECIFICATIONS (UE)

G9 Led Bulbs (Included)
3 x 3W - 3000K Dimmable
220-240 V, 50/60 Hz
IP20, Class I

ENERGY LABEL

A ++

IP20 CE   

MATERIALES

Acero / Acrílico

ACABADOS

Metal:

Negro Mate

Oro Mate

Difusor:

Opal

BOMBILLA RECOMENDADA

B005

ESPECIFICACIONES (UE)

Bombillas G9 Led (Incluidas)
3 x 3W - 3000K Regulable
220-240 V, 50/60 Hz
IP20, Clase I

ETIQUETA ENERGÉTICA

A ++

TECHNICAL

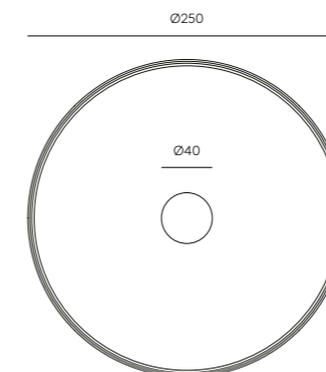

327



ATIL

Wall lamp

A1281

Designed by Pepe Fornas, 2019

DESCRIPTION

MATERIALS

Steel / Glass

FINISHES

Metal:
Matt Black
Matt Brass

Shade:
Opal

RECOMMENDED BULB
B005/5W

SPECIFICATIONS (UE)
G9 Led Bulbs (Included)
2 x 5W - 2700K
220-240 V, 50/60 Hz
IP20, Class I

ENERGY LABEL

A ++



MATERIALES

Acero / Vidrio

ACABADOS

Metal:
Negro Mate
Oro Mate

Tulipa:
Opal

BOMBILLA RECOMENDADA
B005/5W

ESPECIFICACIONES (UE)
Bombillas G9 Led (Incluidas)
2 x 5W - 2700K
220-240 V, 50/60 Hz
IP20, Clase I

ETIQUETA ENERGÉTICA

A ++



TECHNICAL

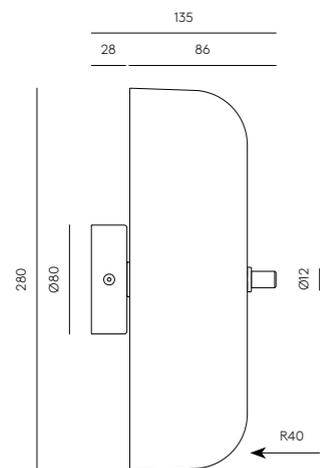

DALT

Wall lamp

A1280

Designed by Pepe Fornas, 2019

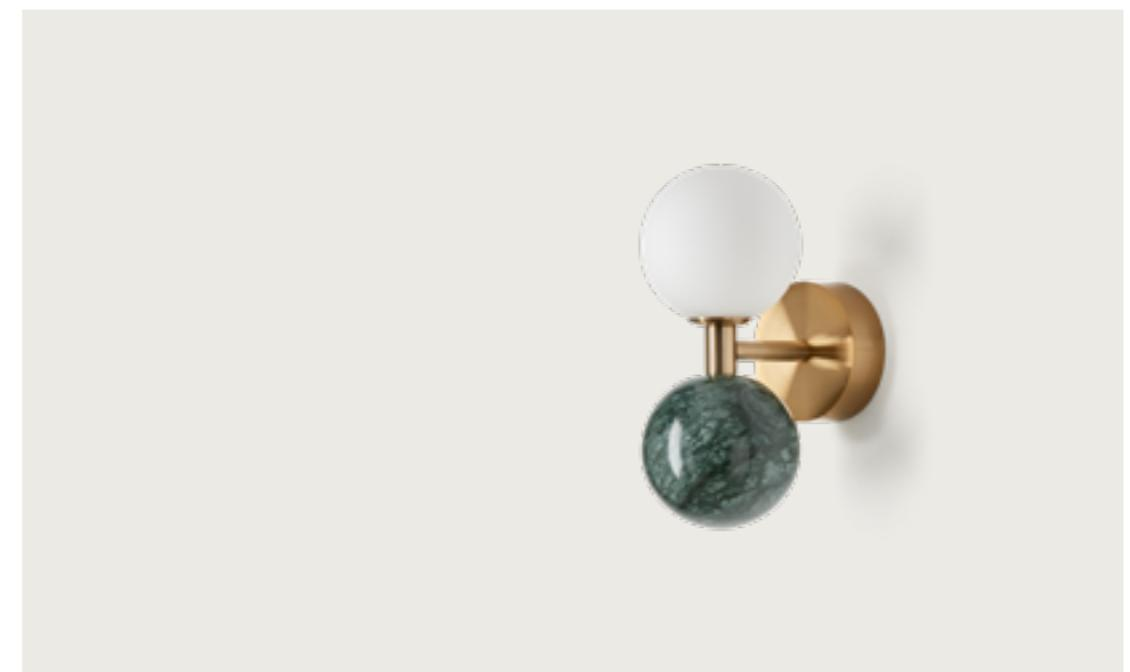

DESCRIPTION

MATERIALS

Steel / Marble / Glass

FINISHES

Body:
Matt Black
Aged Gold

Marble:
Black
White
Green

Glass Shade:
Opal

POSSIBLE MODIFICATIONS
Marble Finishes - extracost

RECOMMENDED BULB
B005/5W

SPECIFICATIONS (UE)
Bulb G9 Led (Included)
5W - 2700K
220-240 V, 50/60 Hz
IP20, Class I

ENERGY LABEL

A ++



MATERIALES

Acero / Mármol / Vidrio

ACABADOS

Metal:
Negro Mate
Oro Envejecido

Mármol:
Negro
Blanco
Verde

Tulipa:
Opal

MODIFICACIONES POSIBLES
Acabado Mármol - sobrecoste

BOMBILLA RECOMENDADA
B005/5W

ESPECIFICACIONES (UE)
Bombilla G9 Led (Incluida)
5W - 2700K
220-240 V, 50/60 Hz
IP20, Clase I

ETIQUETA ENERGÉTICA

A ++

TECHNICAL

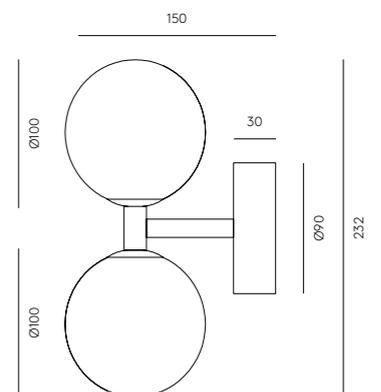

FOCUS

Wall lamp

A1279

Designed by Pepe Fornas, 2019



DESCRIPTION

MATERIALS

Steel / Aluminium or Alabaster

FINISHES

Body:
Matt Black

Head:
Aged Gold
Anthracite
Alabaster

POSSIBLE MODIFICATIONS

Alabaster head (Extra charge)

RECOMMENDED BULB

B161

SPECIFICATIONS (UE)

Bulb GU10 Led (Included)
5W - 2700K
220-240 V, 50/60 Hz
IP20, Class I

ENERGY LABEL

A ++



TECHNICAL

MATERIALES

Acero / Aluminio o Alabastro

ACABADOS

Cuerpo:
Negro Mate

Cabeza:
Oro Viejo
Antracita
Alabastro

MODIFICACIONES POSIBLES

Cabezal Alabastro (Sobrecoste)

BOMBILLA RECOMENDADA

B161

ESPECIFICACIONES (UE)

Bombilla GU10 Led (Incluida)
5W - 2700K
220-240 V, 50/60 Hz
IP20, Clase I

ETIQUETA ENERGÉTICA

A ++

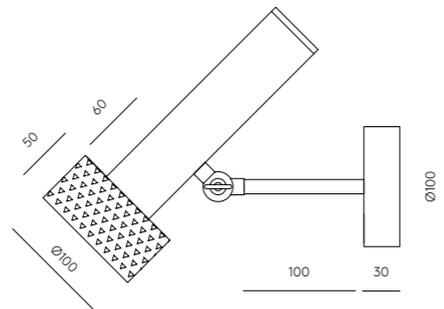

NINO

Wall lamp

A1275

Designed by JF Sevilla, 2021



DESCRIPTION

MATERIALS

Steel / Marble / Glass

FINISHES

Metal:
Matt Black

Details:
Matt gold

Marble:
Matt black

Glass:
Opal

SPECIFICATIONS (UE)

LED Chip 7W
2700K Dimmable
24 V, 50/60 Hz
IP20, Class I

ENERGY LABEL

A ++



MATERIALES

Acero / Mármol / Vidrio

ACABADOS

Metal:
Negro Mate

Detalles:
Oro mate

Mármol:
Negro mate

Vidrio:
Óptico

ESPECIFICACIONES (UE)

Chip LED 7W
2700K Regulable
24 V, 50/60 Hz
IP20, Clase I

ETIQUETA ENERGÉTICA

A ++

TECHNICAL

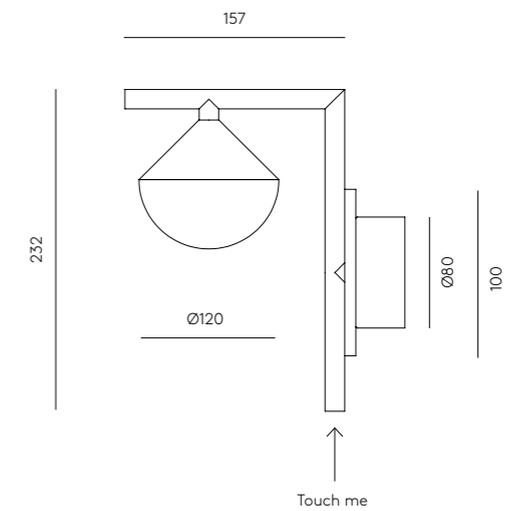



NOOI

Wall lamp

A1276

Designed by Pepe Fornas, 2022

DESCRIPTION

MATERIALS

Linen / Steel / Acrylic

FINISHES

Metal:
Matt Black

Shade:
Cream Linen textile

Acrylic:
Opal

SPECIFICATIONS (UE)

T8 5W Dimmable - 3000K

Triac dimmable

220-240V, 50/60Hz

IP20, Class I

ENERGY LABEL

A ++

MATERIALES

Lino / Metal / Acrílico

ACABADOS

Metal:
Negro mate

Tulipa:
Textil Lino Crema

Acrílico:
Opal

ESPECIFICACIONES (UE)

T8 5W Regulable - 3000K

Regulador Triac

220-240 V, 50/60 Hz

IP20, Clase I

ETIQUETA ENERGÉTICA

A ++

⊕ IP20 CE    

TECHNICAL

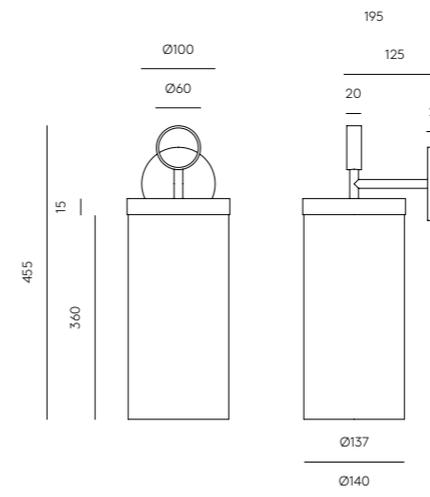

LYB

Wall lamp

A1274

Designed by Pepe Fornas, 2019

DESCRIPTION

MATERIALS

Steel

FINISHES

Metal:
Matt Black

TOUCH ME DIMMABLE

SPECIFICATIONS (UE)

Led integrated 5W,
3000K
12 V, 50/60 Hz
IP20, Class I

ENERGY LABEL

A ++



MATERIALES

Acero

ACABADOS

Metal:
Negro Mate

TOUCH ME REGULABLE

ESPECIFICACIONES (UE)

Led integrado 5W,
3000K
12 V, 50/60 Hz
IP20, Clase I

ETIQUETA ENERGÉTICA

A ++

TECHNICAL

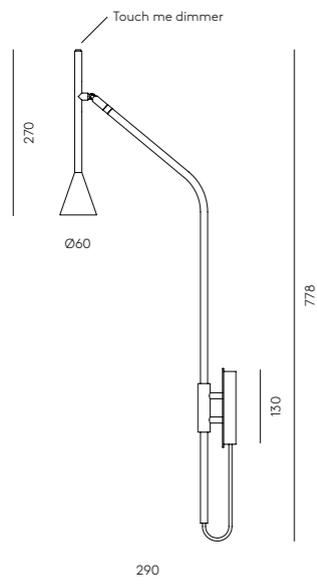

CLOCK

Wall lamp

A1273 /120

Designed by Pepe Fornas, 2019

DESCRIPTION

MATERIALS

Steel

FINISHES

Metal:
Matt Black
Matt Brass

SPECIFICATIONS (UE)

Strip Led integrated
24W - 2700K TRIAC dimmable
12 V, 50/60 Hz
IP20, Class I

ENERGY LABEL

A ++



MATERIALES

Acero

ACABADOS

Metal:
Negro Mate
Oro Mate

ESPECIFICACIONES (UE)

Tira Led integrada
24W - 2700K TRIAC regulable
12 V, 50/60 Hz
IP20, Clase I

ETIQUETA ENERGÉTICA

A ++

TECHNICAL

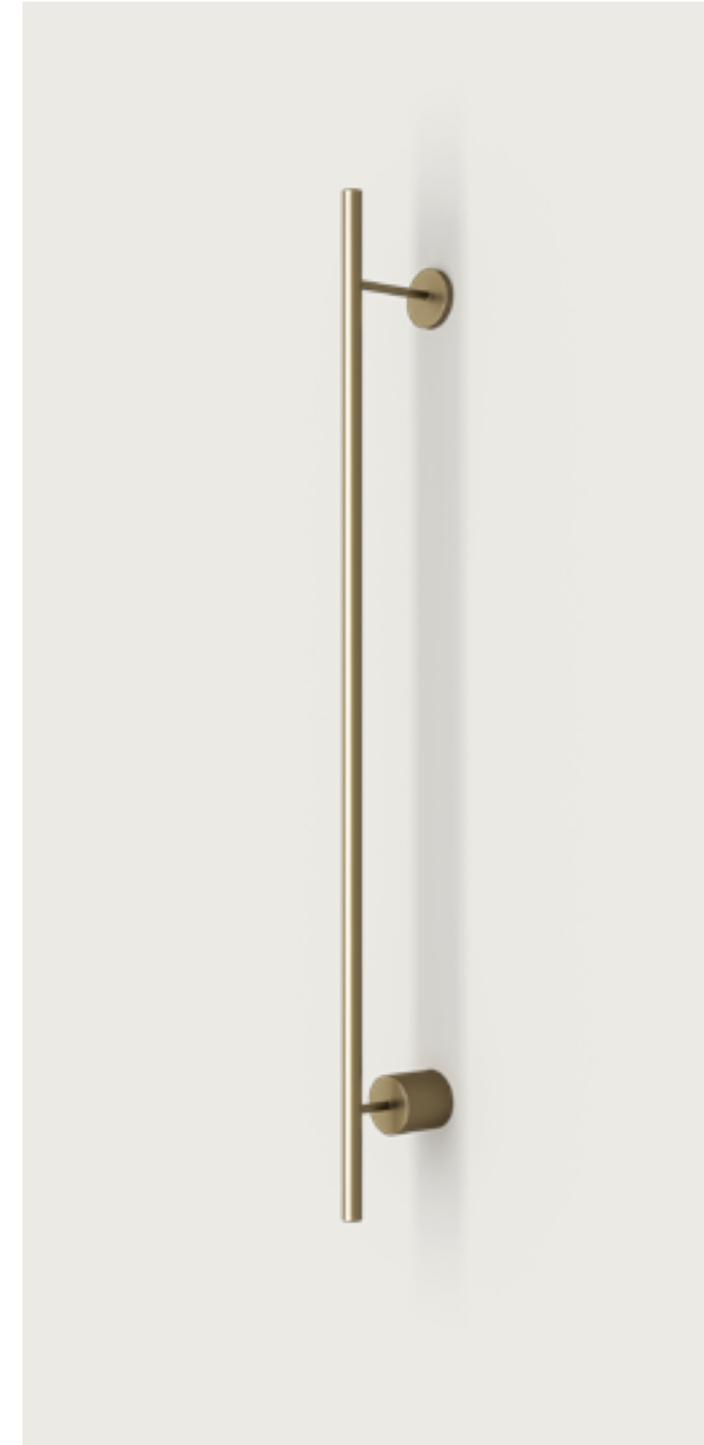
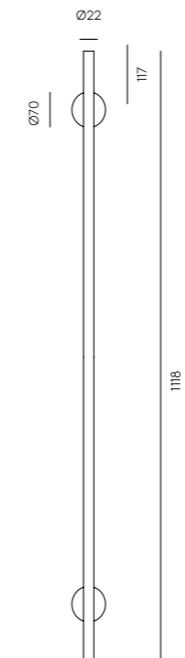

CLOCK

A1273

Designed by Pepe Fornas, 2019

DESCRIPTION

MATERIALS

Steel

FINISHES

Metal:
Matt Black

SPECIFICATIONS (UE)

Strip Led integrated
24W - 2700K TRIAC dimmable
12 V, 50/60 Hz
IP20, Class I

ENERGY LABEL

A ++



MATERIALES

Acero

ACABADOS

Metal:
Negro Mate

ESPECIFICACIONES (UE)

Tira Led integrada
24W - 2700K TRIAC Regulable
12 V, 50/60 Hz
IP20, Clase I

ETIQUETA ENERGÉTICA

A ++

TECHNICAL

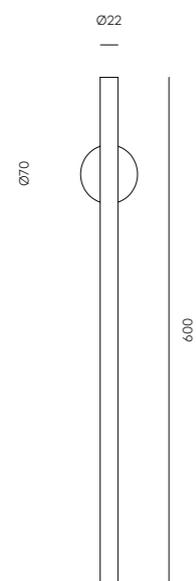

BOT

Wall lamp

A1272

Designed by Pepe Fornas, 2019

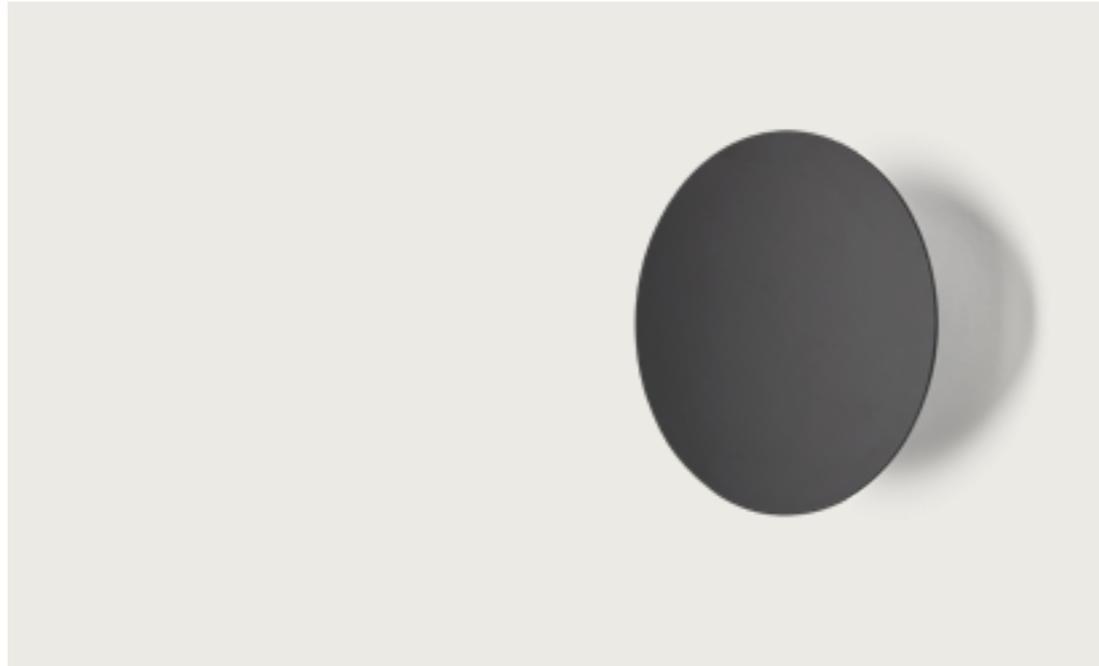

DESCRIPTION

MATERIALS

Steel

FINISHES

Metal:
Matt Black
Matt White

SPECIFICATIONS (UE)

Led integrated
18W - 2700K
12 V, 50/60 Hz
IP20, Class I

ENERGY LABEL

A ++



MATERIALES

Acero

ACABADOS

Metal:
Negro Mate
Blanco Mate

ESPECIFICACIONES (UE)

Led integrado
18W - 2700K
12 V, 50/60 Hz
IP20, Clase I

ETIQUETA ENERGÉTICA

A ++

TECHNICAL

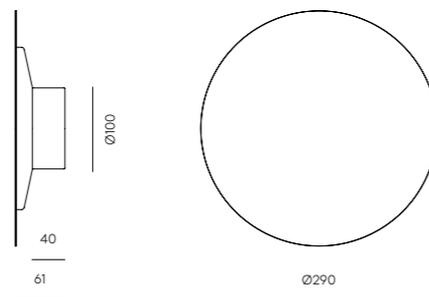

ALMON

Wall lamp

A1264

Designed by Pepe Fornas, 2018



DESCRIPTION

MATERIALS

Steel / Blown Glass / Leather

FINISHES

Metal:
Matt Black

Details:
Matt Brass

Leather:
Brown

RECOMMENDED BULB
B005/5W

SPECIFICATIONS (UE)

Bulb G9 Led (Included)
5W - 2700K
220-240 V, 50/60 Hz
IP20, Class I

ENERGY LABEL

A ++



MATERIALES

Acero / Vidrio soplado / Cuero

ACABADOS

Metal:
Negro Mate

Detalles:
Oro mate

Piel:
Marrón

BOMBILLA RECOMENDADA
B005/5W

ESPECIFICACIONES (UE)

Bombilla G9 Led (Incluida)
5W - 2700K
220-240 V, 50/60 Hz
IP20, Clase I

ETIQUETA ENERGÉTICA

A ++

TECHNICAL

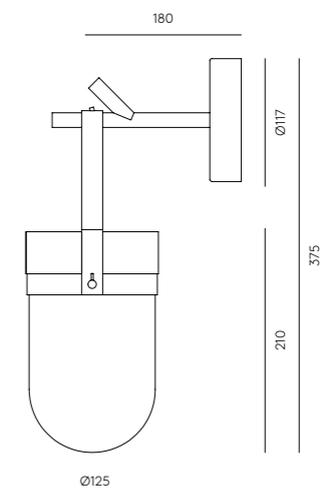



XAGO

Wall lamp

A1262

Designed by Agus Gascón, 2023

DESCRIPTION

MATERIALS

Steel / Acrylic

FINISHES

Metal:
Matt Black/ Matt Brass

Acrylic:
Opal

SPECIFICATIONS (UE)

S14D LED 16W 2700K TRIAC
dimmable
220-240V, 50/60Hz
IP20, Class I

ENERGY LABEL

A ++

MATERIALES

Metal / Acrílico

ACABADOS

Metal:
Negro mate / Oro envejecido

Acrílico:
Opal

ESPECIFICACIONES (UE)

S14D LED 16W 2700K TRIAC
regulable
220-240V, 50/60 Hz
IP20, Clase I

ETIQUETA ENERGÉTICA

A ++

⊕ IP20 CE   

TECHNICAL

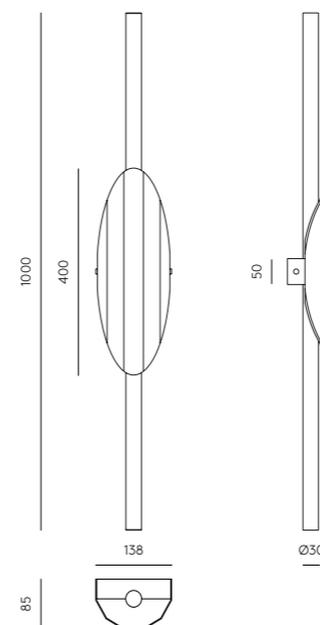

ABBY

A1259/2

Designed by AC Studio, 2022

DESCRIPTION

MATERIALS

Steel

FINISHES

Steel:
Matt black
Matt Brass

SPECIFICATIONS (UE)

2 x E27 Max. 60W
(Not included)
220-240 V, 50/60 Hz
IP20, Class I

Accessories and bulbs not included

ENERGY LABEL

A ++

IP20 CE 

MATERIALES

Acero

ACABADOS

Acero:
Negro mate
Oro envejecido

ESPECIFICACIONES (UE)

2 x E27 Max. 60W
(No incluida)
220-240 V, 50/60 Hz
IP20, Clase I

Accesorios y bombillas no incluidas

ETIQUETA ENERGÉTICA

A ++

TECHNICAL

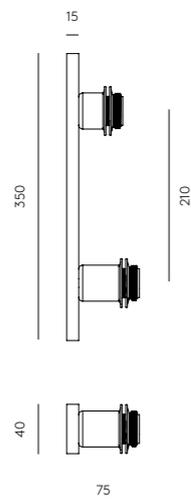

ABBY

Wall lamp

A1259/4

Designed by Pepe Fornas, 2018



DESCRIPTION

MATERIALS

Steel

FINISHES

Steel:
Matt black
Matt Brass

SPECIFICATIONS (UE)

4 x E27 Max. 60W
(Not included)
220-240 V, 50/60 Hz
IP20, Class I

Accessories and bulbs not included

ENERGY LABEL

A ++



MATERIALES

Acero

ACABADOS

Acero:
Negro mate
Oro envejecido

ESPECIFICACIONES (UE)

4 x E27 Max. 60W
(No incluida)
220-240 V, 50/60 Hz
IP20, Clase I

Accesorios y bombillas no incluidas

ETIQUETA ENERGÉTICA

A ++

TECHNICAL

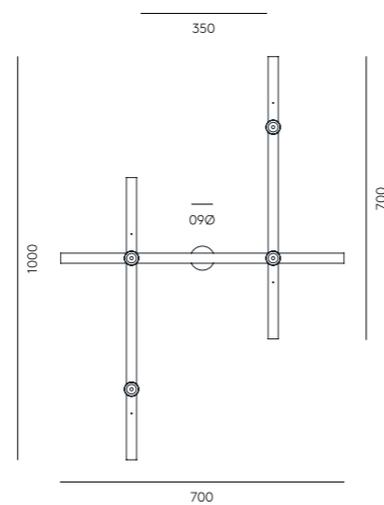

ABBY

Wall lamp

A1259/6

Designed by Pepe Fornas, 2018



DESCRIPTION

MATERIALS

Steel

FINISHES

Steel:
Matt black
Matt Brass

Accessories:
Check page 362

Image composition:

1132 + 2
1038/35
1038/25
1096/35
1097/20

SPECIFICATIONS (UE)

6 x E27 Max. 60W
(Not included)
220-240 V, 50/60 Hz
IP20, Class I

Accessories and bulbs not included

ENERGY LABEL

A ++



MATERIALES

Acero

ACABADOS

Metal:
Negro mate
Oro envejecido

Accesorios:
Consultar pág. 362

Composición imagen:

1132 + 2
1038/35
1038/25
1096/35
1097/20

ESPECIFICACIONES (UE)

6 x E27 Max. 60W
(No incluida)
220-240 V, 50/60 Hz
IP20, Clase I

Accesorios y bombillas no incluidas

ETIQUETA ENERGÉTICA

A ++

TECHNICAL

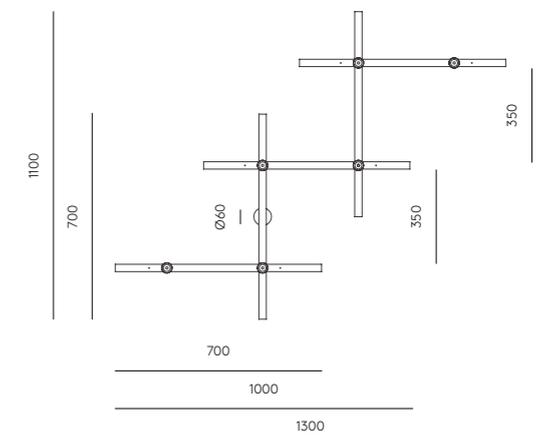

ABBY



ABBACUS

Wall lamp

A1258

Designed by Pepe Fornas, 2018



DESCRIPTION

MATERIALS

Steel / Blown Glass

FINISHES

Metal:
Matt black
Matt Brass

Glass Shade (Included):
Opal
Clear

SPECIFICATIONS (UE)

Bulb G9 (Included)
5W - 2700K
220-240 V, 50/60 Hz
IP20, Class I

ENERGY LABEL

A ++



MATERIALES

Acero / Vidrio Soplado

ACABADOS

Metal:
Negro mate
Oro mate

Cristal (Incluido):
Opal
Transparente

ESPECIFICACIONES (UE)

Bombilla G9 (Incluida)
5W - 2700K
220-240 V, 50/60 Hz
IP20, Clase I

ETIQUETA ENERGÉTICA

A ++

TECHNICAL

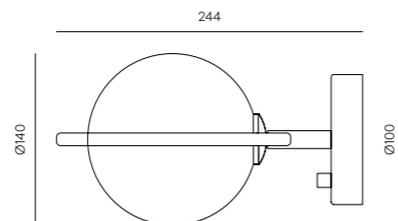

ERTO

Wall lamp

A1257

Designed by AC Studio, 2020



DESCRIPTION

MATERIALS

Steel

FINISHES

Metal:
Matt Black

Details:
Matt Brass

Image Accessory:
1097/20 - Ceramic Disc
Other options 355-356

Accessory included.

RECOMMENDED BULB

B005/5W

SPECIFICATIONS (UE)

G9 LED (Included)
5W - 2700K
220-240 V, 50/60 Hz
IP20, Class I

ENERGY LABEL

A ++



MATERIALES

Acero

ACABADOS

Metal:
Negro Mate

Detalles:
Oro mate

Accesorio Imagen:
1097/20 - Disco Cerámica
Otras opciones 355-356

Accesorio incluido.

BOMBILLA RECOMENDADA

B005/5W

ESPECIFICACIONES (UE)

G9 LED (Incluida)
5W - 2700K
220-240 V, 50/60 Hz
IP20, Clase I

ETIQUETA ENERGÉTICA

A ++

TECHNICAL

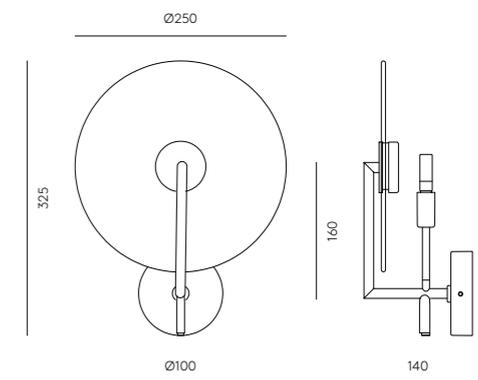

SUAL

Wall lamp

A1255

Designed by Fornasevi, 2020



DESCRIPTION

MATERIALS

Steel / Acrylic

FINISHES

Metal:
Matt black

Compatible Accessories

(Not included)
Alabaster 1096/25 - 35
Alabaster wave 1094/30
Ceramic 1097/20 - 30
Glass 1223
Metal 1038/25-35

SPECIFICATIONS (UE)

Integrated LED plate 9W 3000K
(Included) 24V / 220-240 V,
50/60 Hz
IP20, Class I

ENERGY LABEL

A ++



MATERIALES

Acero / Acrílico

ACABADOS

Metal:
Negro mate

Accesorios compatibles:

(No incluidos)
Alabastro 1096 / 25-35
Alabastro ondulado 1094/30
Cerámica 1097 / 20-30
Cristal 1223
Metal 1038/25-35

ESPECIFICACIONES (UE)

Placa LED integrada 9W 3000K
(Incluida) 24V / 220-240 V,
50/60 Hz
IP20, Clase I

ETIQUETA ENERGÉTICA

A ++

TECHNICAL

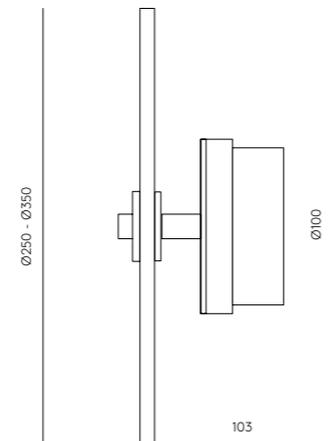

FLEXI LEATHER

Wall lamp

A1248

Designed by AC Studio, 2018



DESCRIPTION

MATERIALS

Steel / Leather

FINISHES

A1248
Metal:
Matt Brass

Leather:

Dark Brown

SPECIFICATIONS (UE)

Led integrated
3W - 2700K
12 V, 50/60 Hz
IP20, Class I

ENERGY LABEL

A ++



MATERIALES

Acero / Piel

ACABADOS

A1248
Metal:
Oro mate

Leather:

Marrón oscuro

ESPECIFICACIONES (UE)

Led integrado
3W - 2700K
12 V, 50/60 Hz
IP20, Clase I

ETIQUETA ENERGÉTICA

A ++

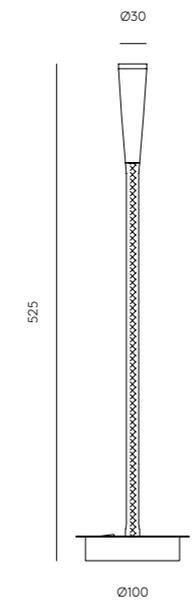

Monte-Carlo, Monaco

MAHO

Wall lamp

A1254

Designed by JF Sevilla, 2018

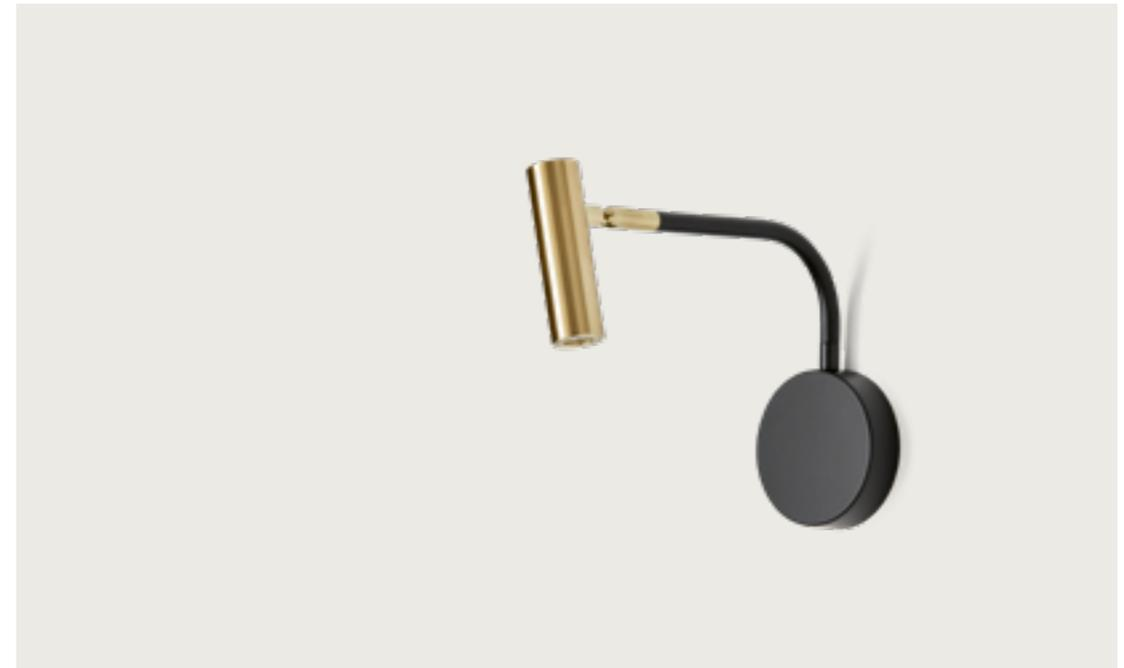

DESCRIPTION

MATERIALS

Steel

FINISHES

Body:
Matt Black

Head:
Matt Black
Matt Brass

SPECIFICATIONS (UE)

Integrated COB LED 5W 3000K
(Included) 220-240 V, 50/60 Hz
Touch Me - Dimmable
IP20, Class I

ENERGY LABEL

A ++

⊕ IP20 CE   

MATERIALES

Acero

ACABADOS

Cuerpo:
Negro Mate

Cabeza:
Negro Mate
Oro Mate

ESPECIFICACIONES (UE)

LED COB integrado 5W 3000K
(Incluido) 220-240 V, 50/60 Hz
Touch Me - Regulable
IP20, Clase I

ETIQUETA ENERGÉTICA

A ++

TECHNICAL

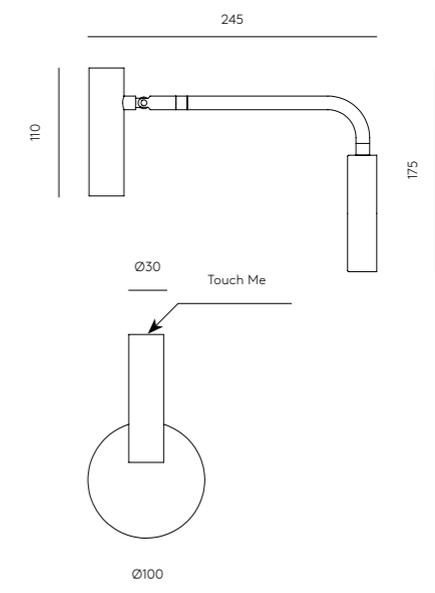

FICUS

Wall lamp

A1243

Designed by JF Sevilla, 2017



DESCRIPTION

MATERIALS

Steel

FINISHES

Metal:
Matt Brass

Shade:
Matt Black

SPECIFICATIONS (UE)

G9 (Included)
5W - 2700K
220-240 V, 50/60 Hz
IP20, Class I

ENERGY LABEL

A ++



MATERIALES

Acero

ACABADOS

Metal:
Oro mate

Tulipa:
Negro Mate

ESPECIFICACIONES (UE)

G9 (Incluida)
5W - 2700K
220-240 V, 50/60 Hz
IP20, Clase I

ETIQUETA ENERGÉTICA

A ++

TECHNICAL

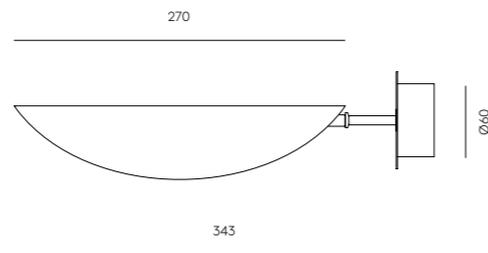

LUCA

Wall lamp

A1237

Designed by AC Studio, 2017

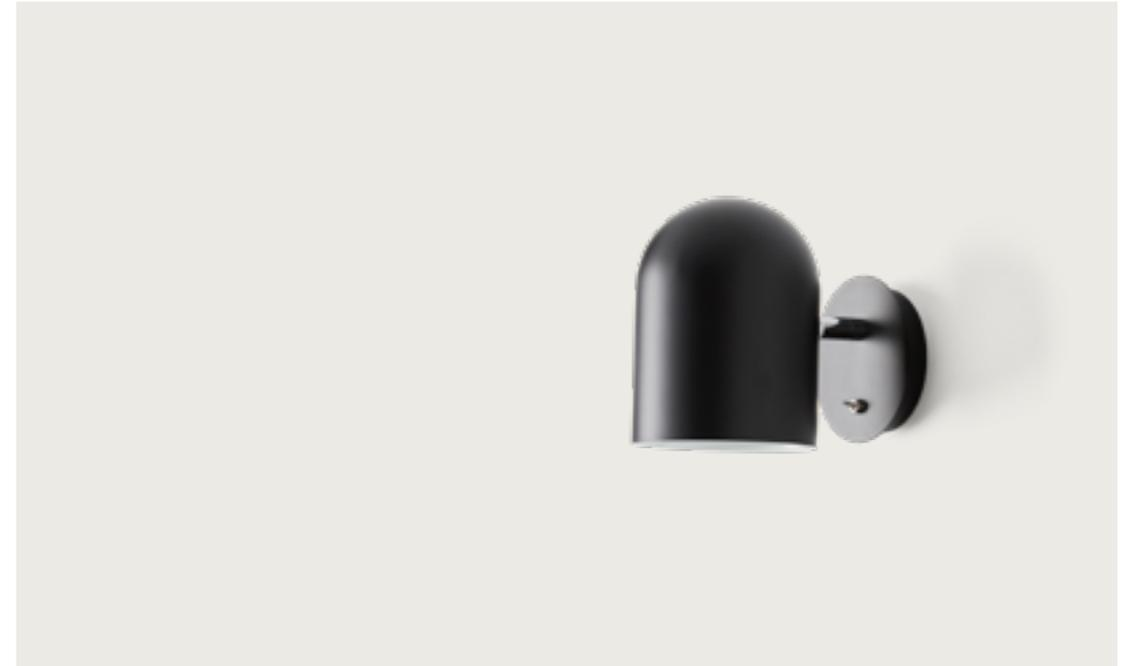

DESCRIPTION

MATERIALS

Steel

FINISHES

Metal:
Black

RECOMMENDED BULB

B211 (7, 9, 11W)

SPECIFICATIONS (UE)

E27 Max. 60W (Not included)
220-240 V, 50/60 Hz
IP20, Class I

ENERGY LABEL

A ++



MATERIALES

Acero

ACABADOS

Metal:
Negro

BOMBILLA RECOMENDADA

B211 (7, 9, 11W)

ESPECIFICACIONES (UE)

E27 Max. 60W (No incluida)
220-240 V, 50/60 Hz
IP20, Clase I

ETIQUETA ENERGÉTICA

A ++

TECHNICAL

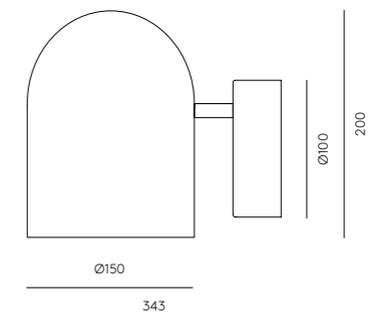

LITA

Wall lamp

A1230

Designed by Pepe Fornas, 2020

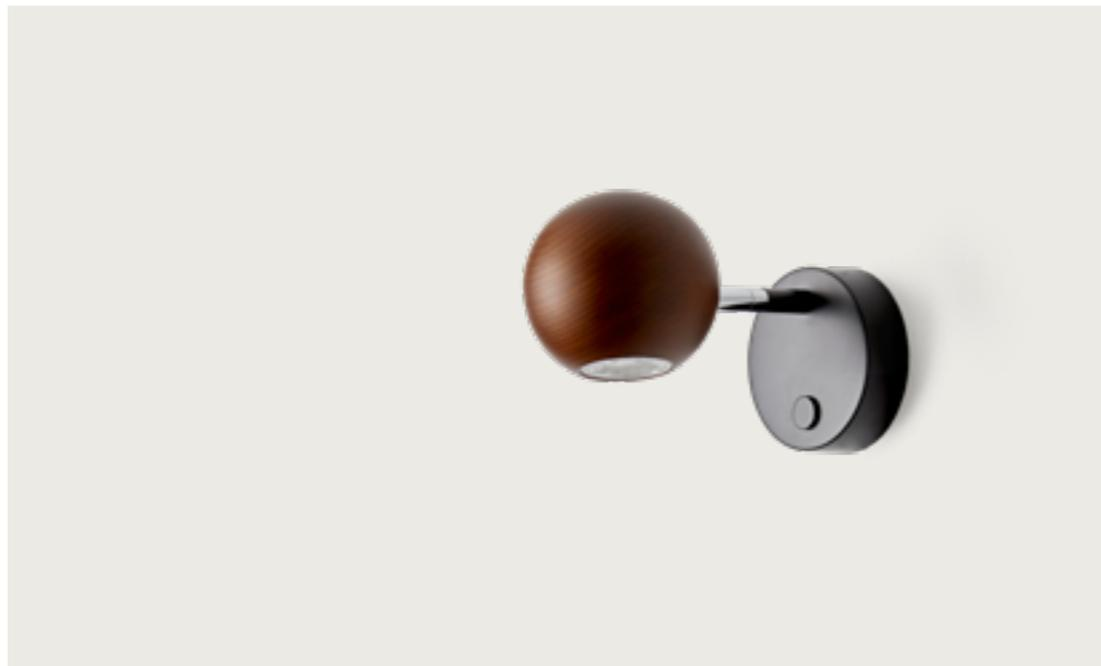

DESCRIPTION

MATERIALS

Steel / Walnut Wood

FINISHES

Metal:
Matt Black

Wood:
Matt black
Walnut

SPECIFICATIONS (UE)

LED COB integrated
3W 3000K (Included)
12V / 220-240 V, 50/60 Hz

ENERGY LABEL

A ++



TECHNICAL

MATERIALES

Acero / Madera nogal

ACABADOS

Metal:
Negro Mate

Madera:
Negro Mate
Nogal

ESPECIFICACIONES (UE)

COB LED integrado
3W 3000K (Incluida)
12V / 220-240 V, 50/60 Hz

ETIQUETA ENERGÉTICA

A ++

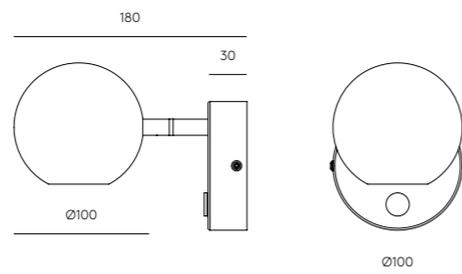

NERA

Wall lamp

A1229

Designed by Pepe Fornas, 2020

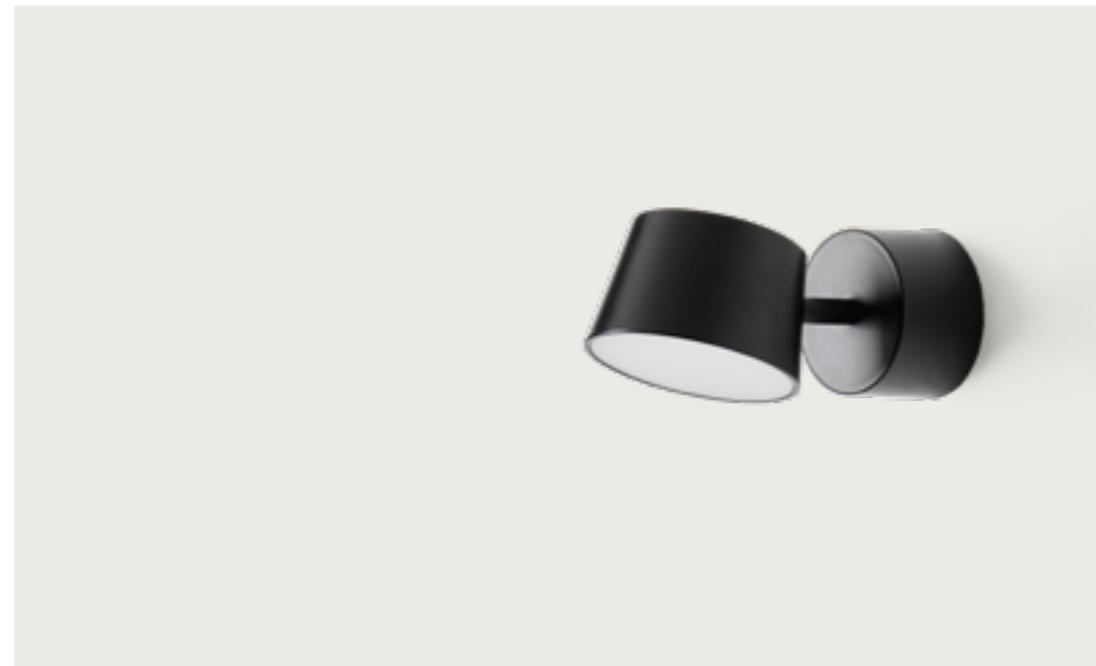

DESCRIPTION

MATERIALS

Steel / Acrylic

FINISHES

Metal:
Matt Black

SPECIFICATIONS (UE)

LED COB integrated 8W 3000K
(Included) Touch me dimmable
on the head
24V / 220-240 V, 50/60 Hz

ENERGY LABEL

A ++



MATERIALES

Acero / Acrílico

ACABADOS

Metal:
Negro Mate

ESPECIFICACIONES (UE)

COB LED integrado 8W 3000K
(Incluida) Touch me regulable en
la cabeza
24V / 220-240 V, 50/60 Hz

ETIQUETA ENERGÉTICA

A ++

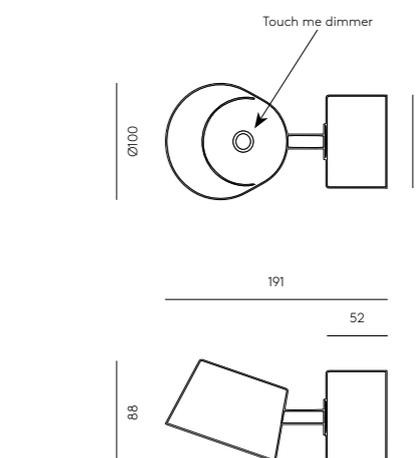



ALOA

Wall lamp

A1227

Designed by Fornasevi, 2017

DESCRIPTION

MATERIALS

Steel

FINISHES

Metal:
Matt Black

Diffuser:
Shiny Gold

RECOMMENDED BULB

B038 / Gold

SPECIFICATIONS (UE)

E27 Max. 60W (Not included)
220-240 V, 50/60 Hz
IP20, Class II

ENERGY LABEL

A ++



MATERIALES

Acero

ACABADOS

Metal:
Negro Mate

Difusor interior:
Oro Brillo

BOMBILLA RECOMENDADA

B038 / Oro

ESPECIFICACIONES (UE)

E27 Max. 60W (No incluida)
220-240 V, 50/60 Hz
IP20, Clase II

ETIQUETA ENERGÉTICA

A ++

TECHNICAL

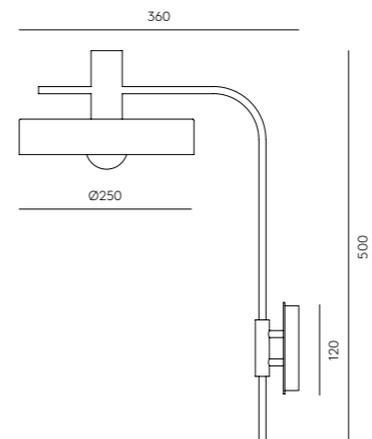

DELIE

Wall lamp

A1224

Designed by JF Sevilla, 2020

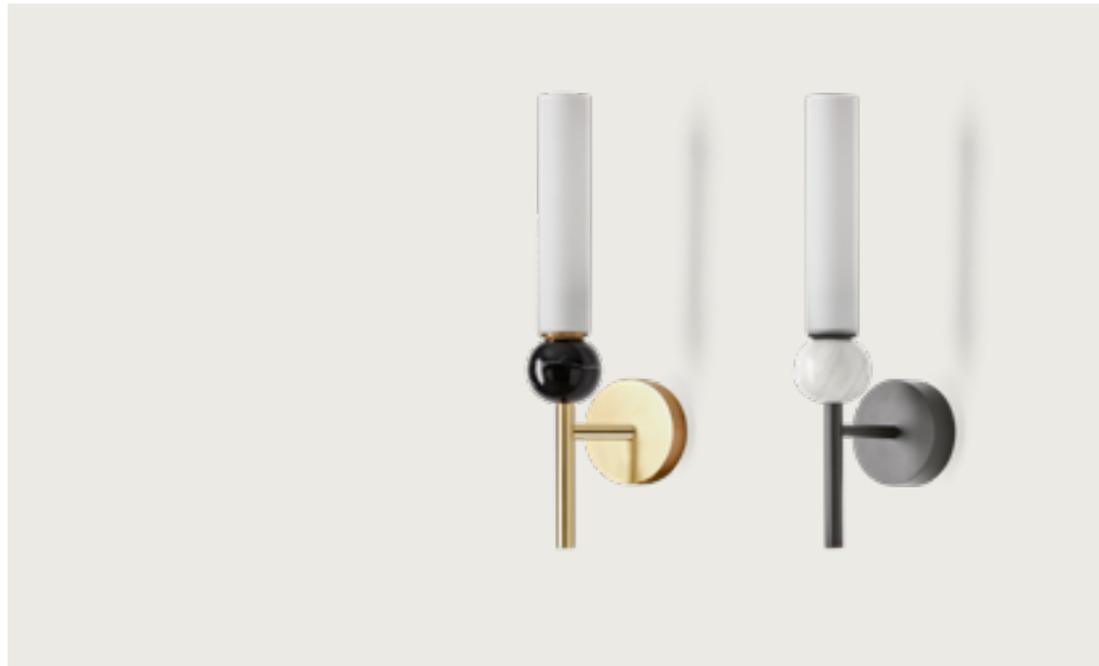

DESCRIPTION

MATERIALS

Steel / Blown Glass / Marble

FINISHES

Metal: Matt Black
Aged Gold
Marble: White
Black

Glass: Opal

RECOMMENDED BULB
B005/5W

SPECIFICATIONS (UE)
G9 LED 5W 2700K (Included)
220-240 V, 50/60 Hz
IP20, Class II

ENERGY LABEL
A ++



MATERIALES

Acero / Vidrio Soplado / Mármol

ACABADOS

Metal: Negro Mate
Oro Envejecido
Mármol: Blanco
Negro

Cristal: Opal

BOMBILLA RECOMENDADA
B005/5W

ESPECIFICACIONES (UE)
G9 LED 5W 2700K (Incluida) 220-
240 V, 50/60 Hz
IP20, Clase II

ETIQUETA ENERGÉTICA
A ++

TECHNICAL

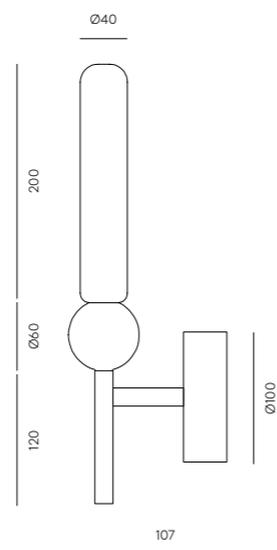

DELIE · L

Wall lamp

A1224/L

Designed by JF Sevilla, 2020

DESCRIPTION

MATERIALS

Steel / Blown Glass / Marble

FINISHES

Metal: Matt Black
Aged Gold
Marble: White
Black

Glass: Opal

RECOMMENDED BULB
B005/5W

SPECIFICATIONS (UE)
G9 LED 5W 2700K (Included)
220-240 V, 50/60 Hz
IP20, Class II

ENERGY LABEL
A ++



MATERIALES

Acero / Vidrio Soplado / Mármol

ACABADOS

Metal: Negro Mate
Oro Envejecido
Mármol: Blanco
Negro

Cristal: Opal

BOMBILLA RECOMENDADA
B005/5W

ESPECIFICACIONES (UE)
G9 LED 5W 2700K (Incluida) 220-
240 V, 50/60 Hz
IP20, Clase II

ETIQUETA ENERGÉTICA
A ++

TECHNICAL

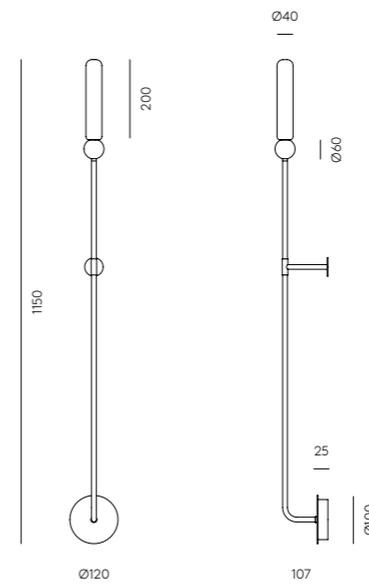

HELMET

Wall lamp

A1221

Designed by Pepe Fornas, 2016

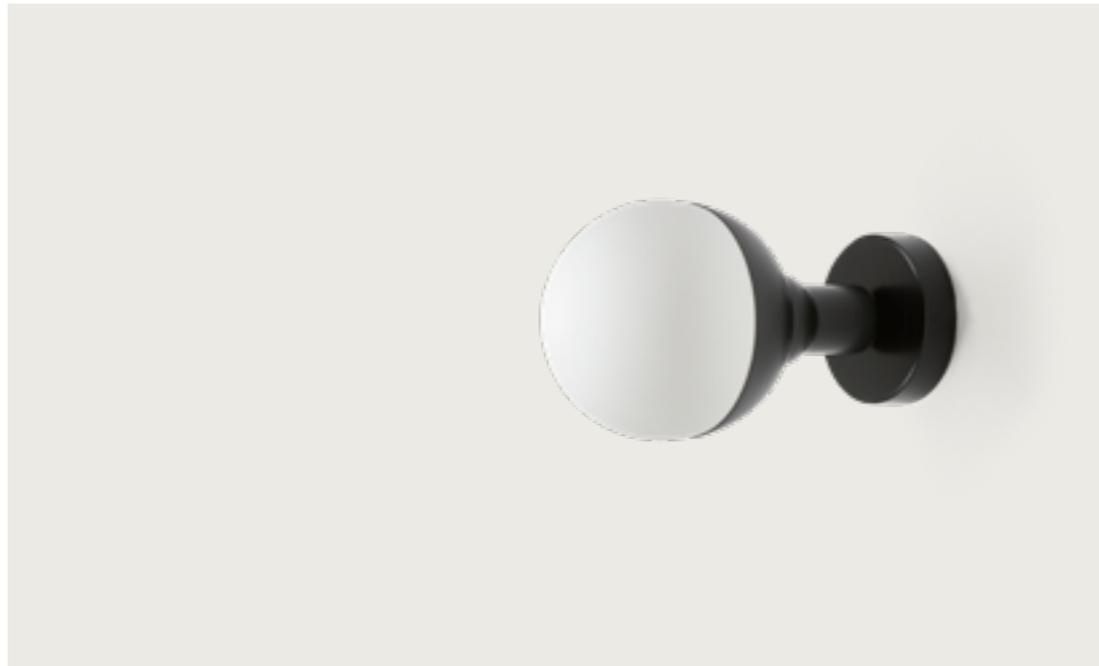

DESCRIPTION

MATERIALS

Steel / Blown Glass

FINISHES

Metal:
Shinny Gold
Matt Brass
Matt Black
Chrome

BULB INCLUDED

B033/COB
B034/COB

SPECIFICATIONS (UE)

E27 2700K - 270 lm
(Bulb included)
220-240 V, 50/60 Hz
IP20, Class I

ENERGY LABEL

A ++



TECHNICAL

MATERIALES

Acero / Vidrio Soplado

ACABADOS

Metal:
Oro (Brillo o Mate)
Negro Mate
Cromo

BOMBILLA INCLUIDA

B033/COB
B034/COB

ESPECIFICACIONES (UE)

E27 2700K - 270 lm
(Bombilla incluida)
220-240 V, 50/60 Hz
IP20, Clase I

ETIQUETA ENERGÉTICA

A ++

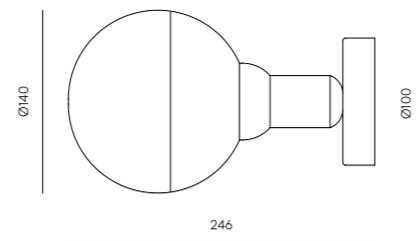

HELMET CURVE

Wall lamp

A1219

Designed by Pepe Fornas, 2016

DESCRIPTION

MATERIALS

Steel / Blown Glass

FINISHES

Metal:
Matt Brass
Matt Black

BULB INCLUDED

B033/COB
B034/COB

SPECIFICATIONS (UE)

E27 - B033/COB included (opal)
3W - 3000K
220-240 V, 50/60 Hz
IP20, Class I

ENERGY LABEL

A ++



MATERIALES

Acero / Vidrio Soplado

ACABADOS

Metal:
Oro Mate
Negro Mate

BOMBILLA INCLUIDA

B033/COB
B034/COB

ESPECIFICACIONES (UE)

E27 - B033/COB incluida (opal)
3W - 3000K
220-240 V, 50/60 Hz
IP20, Clase I

ETIQUETA ENERGÉTICA

A ++

TECHNICAL

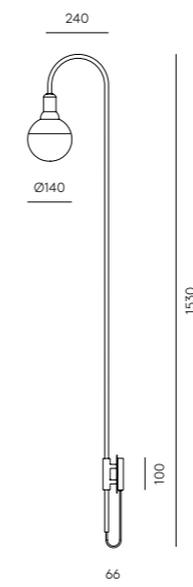

LIND

Wall lamp

A1220

Designed by Agus Gascón, 2016

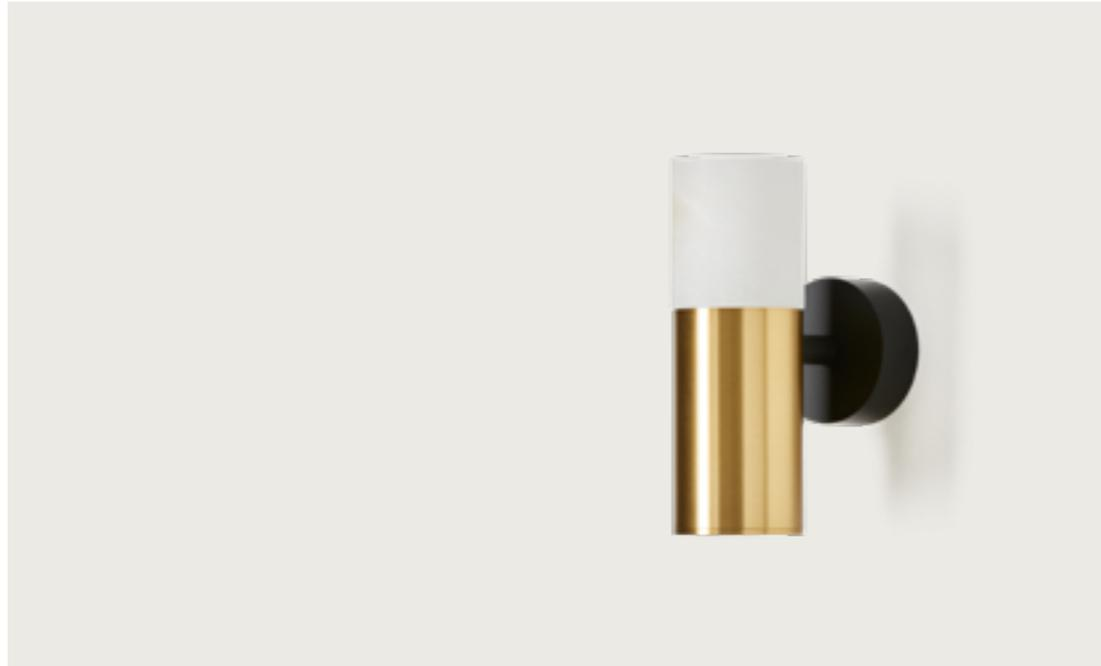

DESCRIPTION

MATERIALS

Steel / Alabaster

FINISHES

Metal:
Matt Brass
Matt Black

Shade:
Alabaster

RECOMMENDED BULB
B005/5W

SPECIFICATIONS (UE)

G9 (Included)
5W - 2700K
220-240 V, 50/60 Hz
IP20, Class I

ENERGY LABEL

A ++



TECHNICAL

MATERIALES

Acero / Alabastro

ACABADOS

Metal:
Oro Mate
Negro Mate

Tulipa:
Alabastro

BOMBILLA RECOMENDADA
B005/5W

ESPECIFICACIONES (UE)

G9 (Incluida)
5W - 2700K
220-240 V, 50/60 Hz
IP20, Clase I

ETIQUETA ENERGÉTICA

A ++

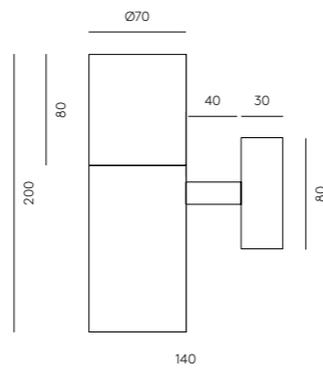

ATOM

Wall lamp

A1214

Designed by AC Studio, 2016

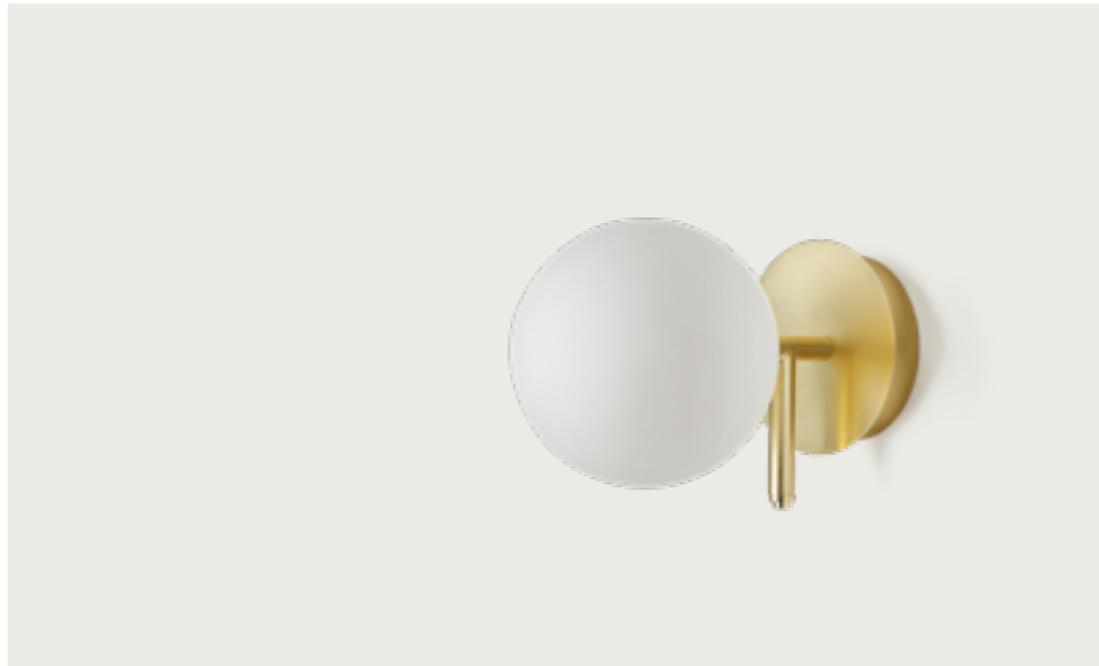

DESCRIPTION

MATERIALS

Steel / Blown Glass

FINISHES

Metal:
Matt Black
Matt Brass

Shade (Included):
Opal
Clear

INCLUDED BULB
B005/5W

SPECIFICATIONS (UE)
Bulb G9 (Included)
5W - 2700K
220-240 V, 50/60 Hz
IP20, Class I

ENERGY LABEL
A ++



MATERIALES

Acero / Vidrio Soplado

ACABADOS

Metal:
Negro Mate
Oro Mate

Cristal (Incluido):
Opal
Transparente

BOMBILLA INCLUIDA
B005/5W

ESPECIFICACIONES (UE)
Bombilla G9 (Incluida)
5W - 2700K
220-240 V, 50/60 Hz
IP20, Clase I

ETIQUETA ENERGÉTICA
A ++

TECHNICAL

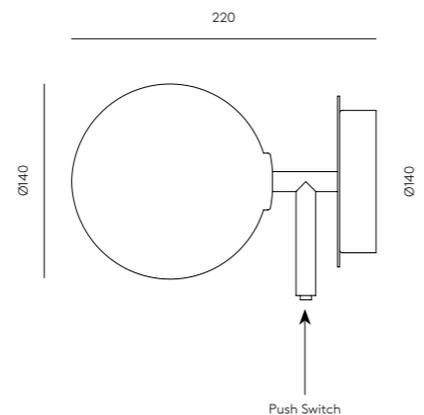

DOBI

Wall lamp

A1207

Designed by AC Studio, 2015



DESCRIPTION

MATERIALS

Steel

FINISHES

Metal:
Matt Black
Matt White

RECOMMENDED BULB
B116-2 / 5W

SPECIFICATIONS (UE)
E14 Max. 40W (Not included)
220-240 V, 50/60 Hz
IP20, Class I

ENERGY LABEL
A ++



MATERIALES

Acero

ACABADOS

Metal:
Negro Mate
Blanco Mate

BOMBILLA RECOMENDADA
B116-2 / 5W

ESPECIFICACIONES (UE)
E14 Max. 40W (No incluida)
220-240 V, 50/60 Hz
IP20, Clase I

ETIQUETA ENERGÉTICA
A ++

TECHNICAL

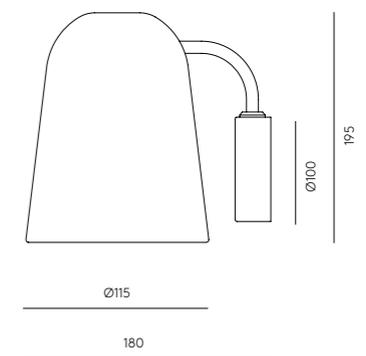



COSS

Wall lamp

A1203

Designed by AC Studio, 2020

DESCRIPTION

MATERIALS

Steel / Acrylic

FINISHES

Dome:

Black
White

Diffuser:

Black
White
Matt Brass
Chrome

SPECIFICATIONS (UE)

A1203/40: Integrated LED 12W
3000K, 220-240 V, 50/60 Hz,
IP20, Class I

A1203/60: Integrated LED 21W
3000K, 220-240 V, 50/60 Hz,
IP20, Class I

ENERGY LABEL

A ++

⊕ IP20 CE   

MATERIALES

Acero / Acrílico

ACABADOS

Cúpula:

Negro
Blanco

Difusor:

Negro
Blanco
Oro Mate
Cromo

ESPECIFICACIONES (UE)

A1203/40: LED integrado 12W
3000K, 220-240 V, 50/60 Hz,
IP20, Clase I

A1203/60: LED integrado 21W
3000K, 220-240 V, 50/60 Hz,
IP20, Clase I

ETIQUETA ENERGÉTICA

A ++

TECHNICAL

A1203/40

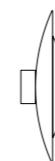

120

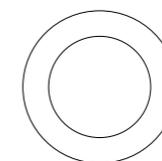

Ø400

Ø250

A1203/60



140

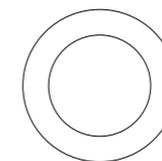

Ø600

Ø400



BIGCOSS

A1203/80

Designed by Ac Studio, 2023

DESCRIPTION

MATERIALS

Metal / Acrylic / Crystal

FINISHES

Body:
Matt Black

Diffuser:
Mirror

SPECIFICATIONS

25W 2700K LED strip

Touch me dimmable

24V, 50/60Hz

IP20, Class I

ENERGY LABEL

A ++

MATERIALES

Metal / Acrílico / Cristal

ACABADOS

Cuerpo:
Negro Mate

Difusor:
Espejo

ESPECIFICACIONES

Tira LED 25W 2700K

Touch me regulable

24 V, 50/60 Hz

IP20, Clase I

ETIQUETA ENERGÉTICA

A ++

⊕ IP20 CE   

TECHNICAL

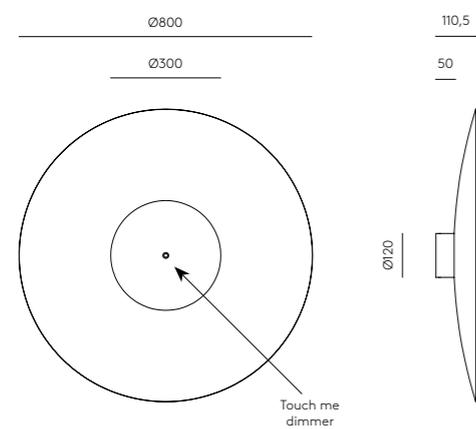

MARU

Wall lamp

A1194

Designed by JF Sevilla, 2015

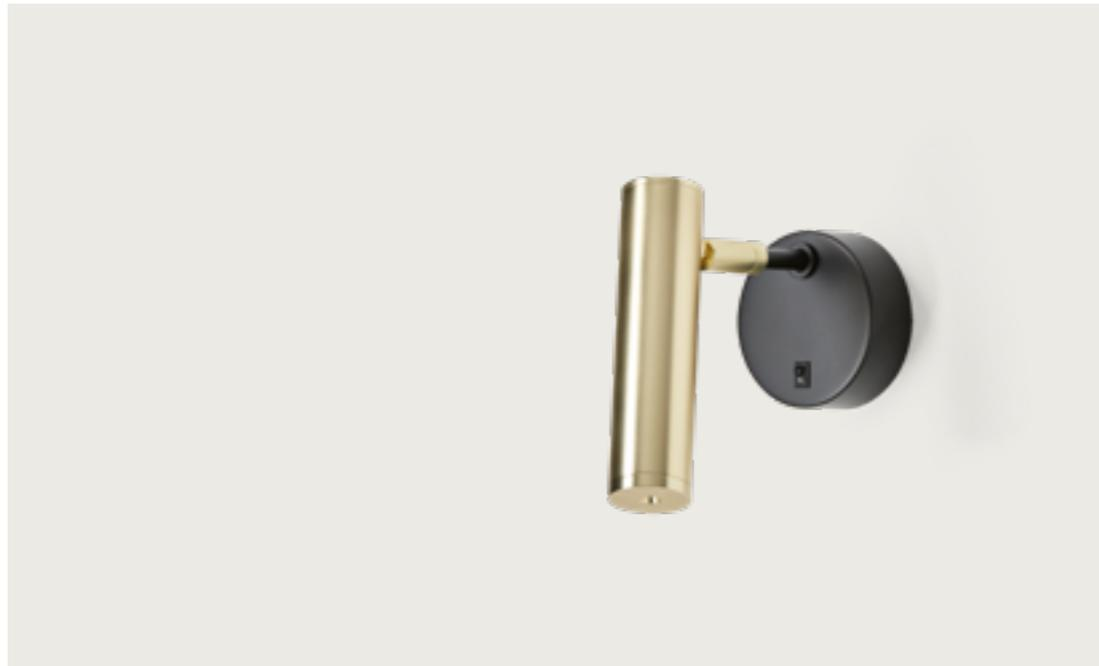

DESCRIPTION

MATERIALS

Steel

FINISHES

Canopy:
Matt Black

Head:
Matt Brass
Matt Black

SPECIFICATIONS (UE)

Chip Led Integrated
3W - 3150K
12 V, 50/60 Hz
IP20, Class I

ENERGY LABEL

A ++



MATERIALES

Acero

ACABADOS

Florón:
Negro Mate

Cabeza:
Oro Mate
Negro Mate

ESPECIFICACIONES (UE)

Chip Led integrado
3W - 3150K
12 V, 50/60 Hz
IP20, Clase I

ETIQUETA ENERGÉTICA

A ++

TECHNICAL

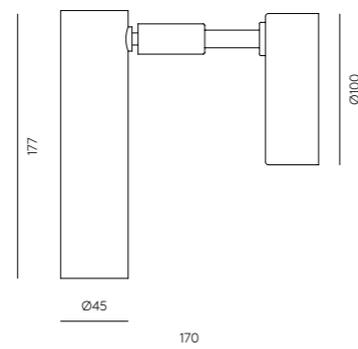

LOTTO

Wall lamp

A1176 / A1175 / A1174

Designed by AC Studio, 2014



DESCRIPTION

MATERIALS

Steel / Glass

FINISHES

Metal:
Shinny Gold
Chrome
White
Black

Glass:
Clear

SIZES

A1176 - Ø250 X 150
A1175 - Ø200 X 120
A1174 - Ø150 X 100

LED DIFFUSER OPTION

A1176/LED:
LED 9W 3000K

SPECIFICATIONS (UE)

Bulb Led included - B030
2W - 2700K
IP20, Class I

ENERGY LABEL

A ++



MATERIALES

Acero / Cristal

ACABADOS

Metal:
Oro Brillo
Cromo
Blanco
Negro

Cristal:
Transparente

MEDIDAS

A1176 - Ø250 X 150
A1175 - Ø200 X 120
A1174 - Ø150 X 100

OPCIÓN DIFUSOR LED

A1176/LED:
LED 9W 3000K

ESPECIFICACIONES (UE)

Bombilla Led incluida - B030
2W - 2700K
IP20, Clase I

ETIQUETA ENERGÉTICA

A ++

TECHNICAL

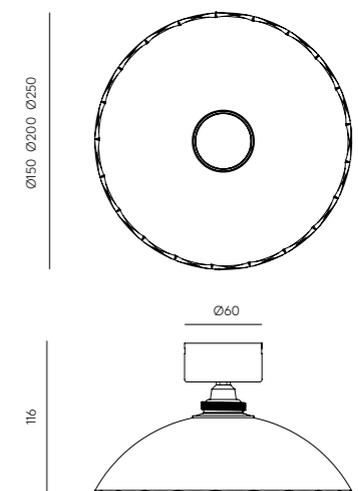



DUO

Wall lamp

A1170/2
Designed by AC Studio, 2021

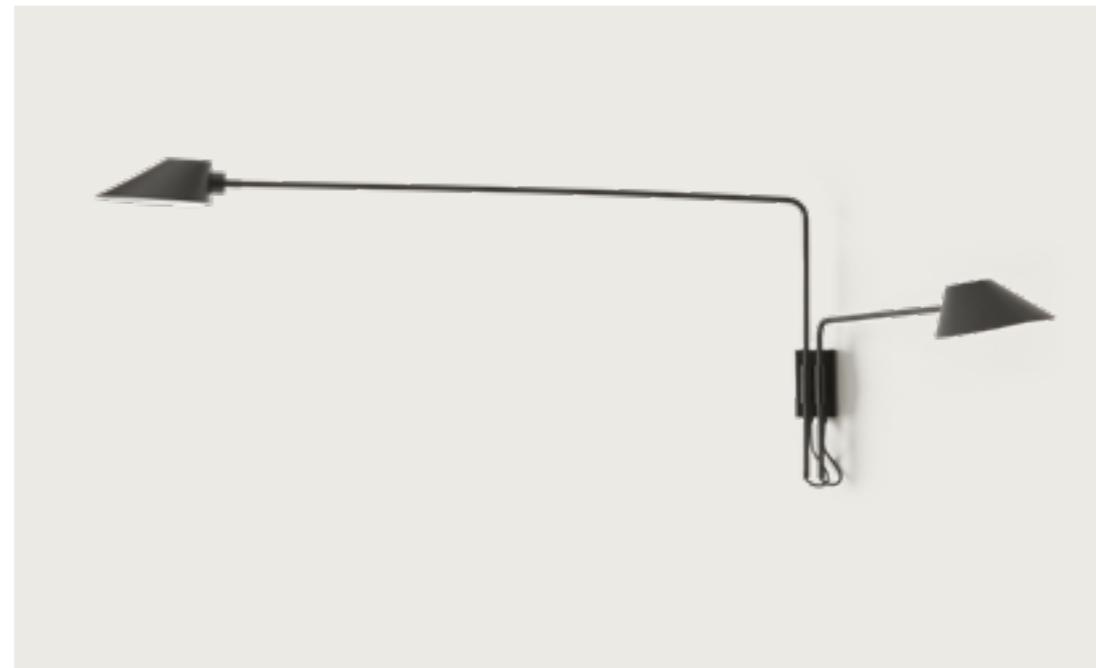

DESCRIPTION

MATERIALS

Steel

FINISHES

Body:
Matt Black

Tulip:
Matt black outside
Matt white inside

SPECIFICATIONS (UE)

2x E27 max. 60W LED (no included) 230V, 50/60 Hz, IP20, Class I

ENERGY LABEL

A++



MATERIALES

Acero

ACABADOS

Cuerpo:
Negro Mate

Tulipa:
Negro mate exterior
Blanco mate interior

ESPECIFICACIONES (UE)

2 x E27 max. 60W LED (no incluido) 230V, 50/60 Hz, IP20, Clase I

ETIQUETA ENERGÉTICA

A++

TECHNICAL

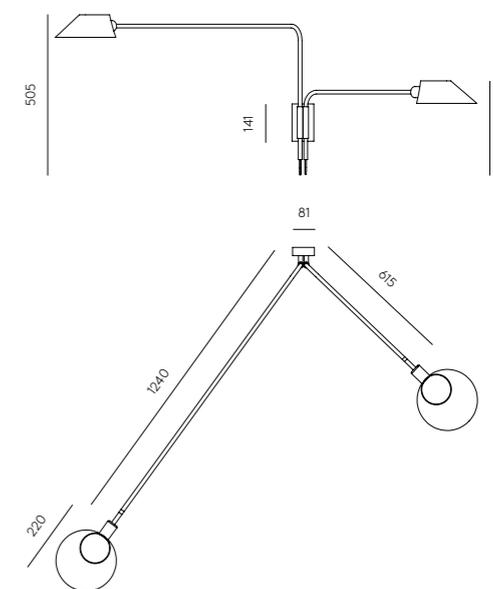

CALP

A1168

Designed by AC Studio, 2022

DESCRIPTION

MATERIALS

Ceramics

FINISHES

Ceramics:
Hand painted
See colour palette
Image colour: Nude

SPECIFICATIONS (UE)

G9 Led Bulbs 5W - 3000K
(Included)
220-240V, 50/60Hz
IP20, Class I

ENERGY LABEL

A ++

⊕ IP20 CE    

MATERIALES

Cerámica

ACABADOS

Cerámica:
Pintado a mano
Consultar paleta de colores
Color en imagen: Nude

ESPECIFICACIONES (UE)

G9 Bombillas Led 5W - 3000K
(Incluida)
220-240 V, 50/60 Hz
IP20, Clase I

ETIQUETA ENERGÉTICA

A ++

TECHNICAL

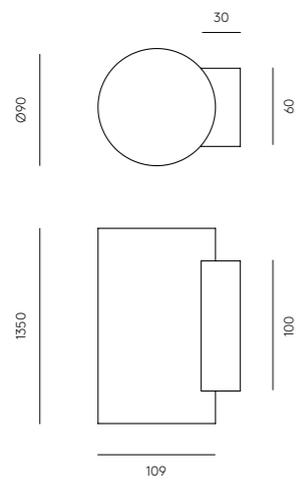

IBRE

Wall lamp

A1162

Designed by AC Studio, 2021

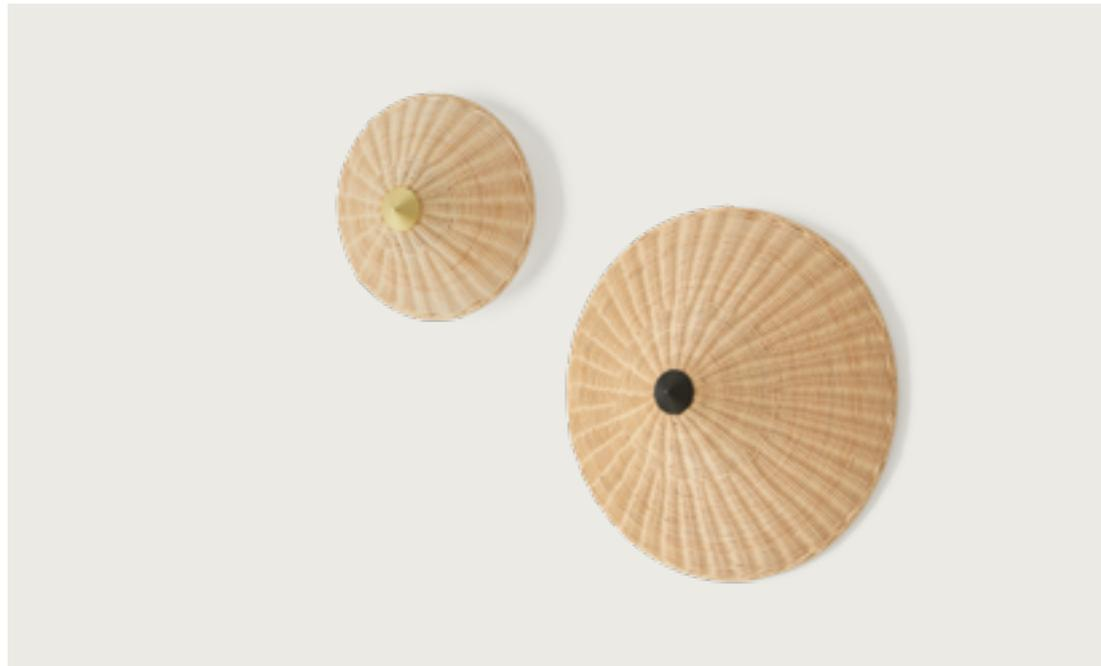

DESCRIPTION

MATERIALS

Steel / Wicker

FINISHES

Metal:
Matt Gold
Matt Black

Shade:
Natural Wicker

SPECIFICATIONS (UE)

A1163/30:
COB LED 9W- 2700K
TRIAC dimmable - IP20, Class I
220-240V - 24V, 50/60 Hz

A1120/22
COB LED 9W- 3000K
Dimmable - IP20, Class I
220-240V - 24V, 50/60 Hz

ENERGY LABEL

A ++



MATERIALES

Acero / Mimbres

ACABADOS

Metal:
Oro mate
Negro Mate

Pantalla:
Mimbres natural

ESPECIFICACIONES (UE)

A1163/30:
Placa LED 9W- 2700K
Regulable TRIAC - IP20, Clase I
220-240V - 24V, 50/60 Hz

A1120/22
Placa LED 9W- 3000K
Regulable - IP20, Clase I
220-240V - 24V, 50/60 Hz

ETIQUETA ENERGÉTICA

A ++

TECHNICAL

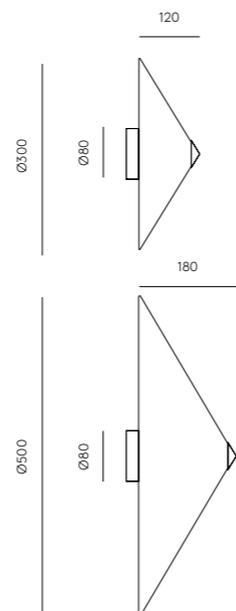

VENT

Wall lamp

A1161

Designed by Pepe Fornas, 2020

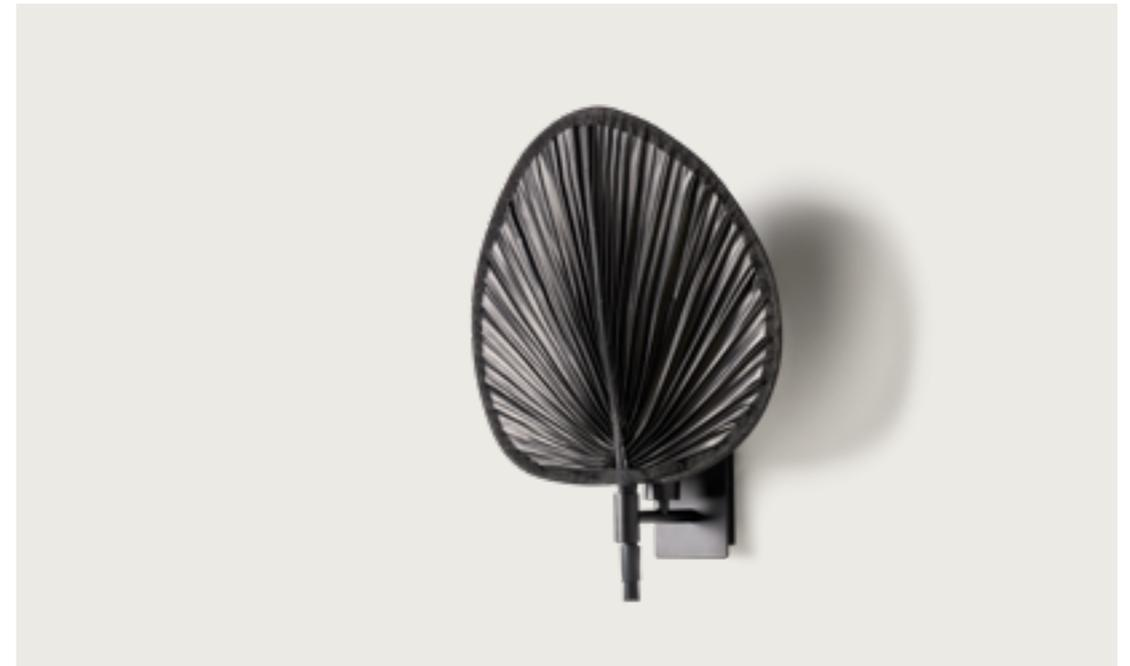

DESCRIPTION

MATERIALS

Steel / Palm leaf

FINISHES

Metal:
Black

Pai Pai Leaf:
Black - Black Ribon
Natural - Black Ribon

SPECIFICATIONS (UE)

G9 LED 5W 2700K (Included)
220-240 V, 50/60 Hz

ENERGY LABEL

A ++



MATERIALES

Acero / Hoja de Palma

ACABADOS

Metal:
Negro Mate

Hoja Pai Pai:
Natural / Ribete Negro
Negro / Ribete Negro

ESPECIFICACIONES (UE)

G9 LED 5W 2700K (Incluida) 220-
240 V, 50/60 Hz

ETIQUETA ENERGÉTICA

A ++

TECHNICAL

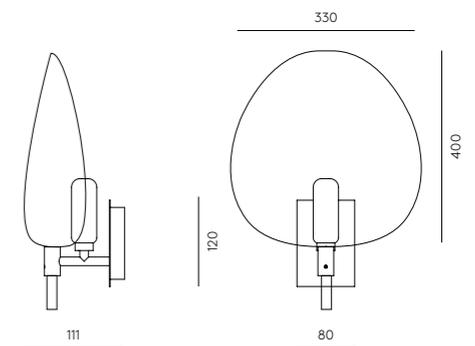

FLEXOR

Wall lamp

A1151

Designed by AC Studio, 2009



DESCRIPTION

MATERIALS

Steel / Silicon

FINISHES

Metal:
Matt White
Matt Black

SPECIFICATIONS (UE)

3W LED (Included)
3000K, 12 V, 50/60 Hz
IP20, Class I

ENERGY LABEL

A ++



MATERIALES

Acero / Silicona

ACABADOS

Metal:
Blanco Mate
Negro Mate

ESPECIFICACIONES (UE)

3W LED (Incluido)
3000K, 12 V, 50/60 Hz
IP20, Clase I

ETIQUETA ENERGÉTICA

A ++

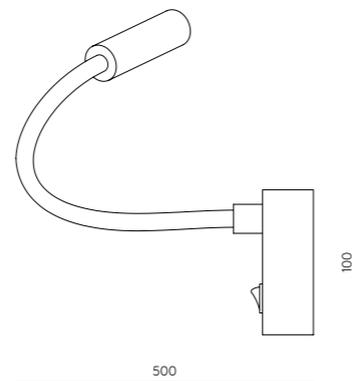

TECHNICAL

PILD

Wall lamp

A1149

Designed by Pepe Fornas, 2019

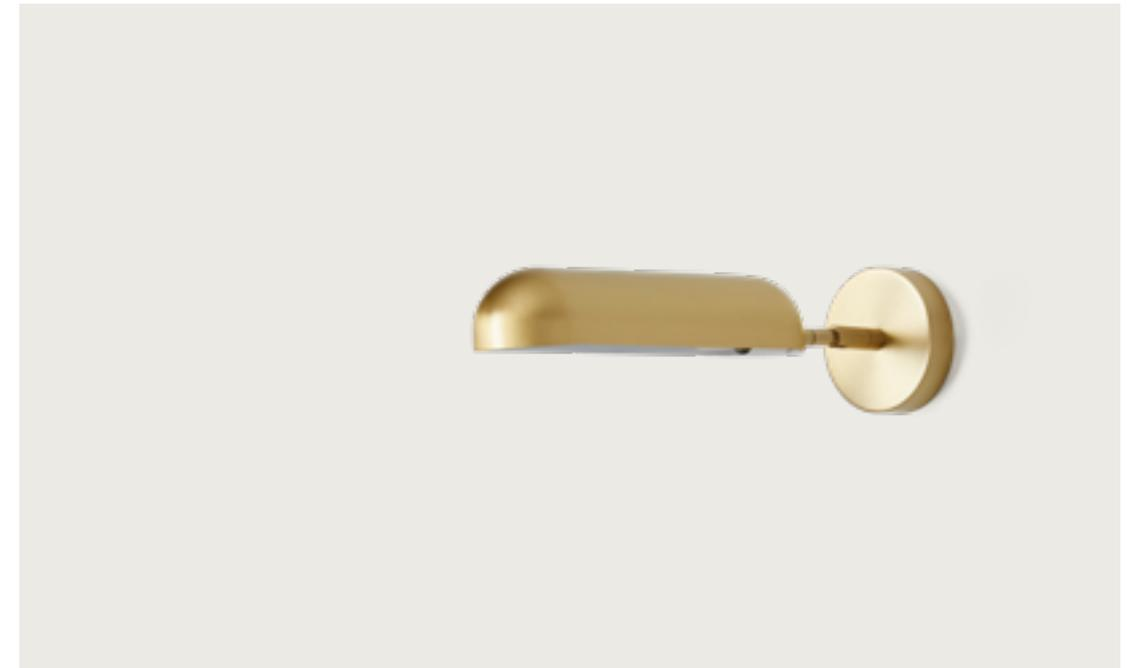

DESCRIPTION

MATERIALS

Steel

FINISHES

Metal:
Matt Brass
Matt Black

Inside white

RECOMMENDED BULB

B005

SPECIFICATIONS (UE)

Bulb G9 (NOT included)
5W - 2700K
220-240 V, 50/60 Hz
IP20, Class I

ENERGY LABEL

A ++



MATERIALES

Acero

ACABADOS

Metal:
Oro Mate
Negro Mate

Interior blanco

BOMBILLA RECOMENDADA

B005

ESPECIFICACIONES (UE)

Bombilla G9 LED (NO Incluida)
5W - 2700K
220-240 V, 50/60 Hz
IP20, Clase I

ETIQUETA ENERGÉTICA

A ++

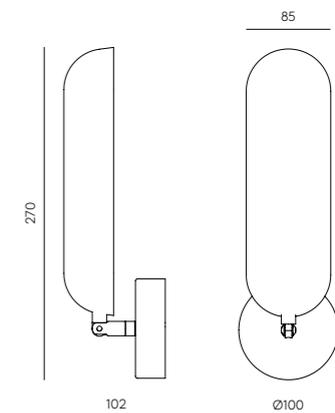



AORA

Wall lamp

A1129

Designed by AC Studio, 2023



DESCRIPTION

MATERIALS

Steel / Ceramics

FINISHES

Metal:
Shiny gold
Chrome

White
Black

Ceramics:

Hand painted
See colour palette

Image colours:

Left: Nude
Right: Vintage brown

SPECIFICATIONS (UE)

Direct LED plate 7W 3000K

220-240V, 50/60Hz

IP20, Class I

ENERGY LABEL

A ++



MATERIALES

Acero / Cerámica

ACABADOS

Metal:
Oro Brillo
Cromo

Blanco
Negro

Cerámica:

Pintada a mano
Consultar paleta de colores

Colores en imagen:

Izda. Nude
Dcha. Marrón vintage

ESPECIFICACIONES (UE)

Placa LED directa 7W 3000K

220-240 V, 50/60 Hz

IP20, Clase I

ETIQUETA ENERGÉTICA

A ++

TECHNICAL

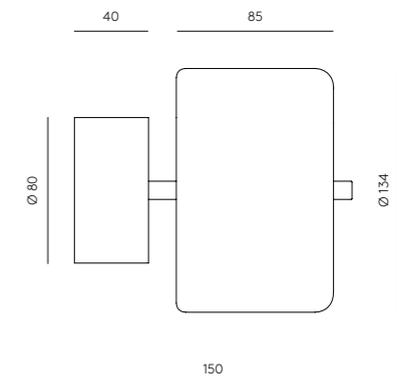

OSION

Wall lamp

A1132

Designed by JF Sevilla, 2019

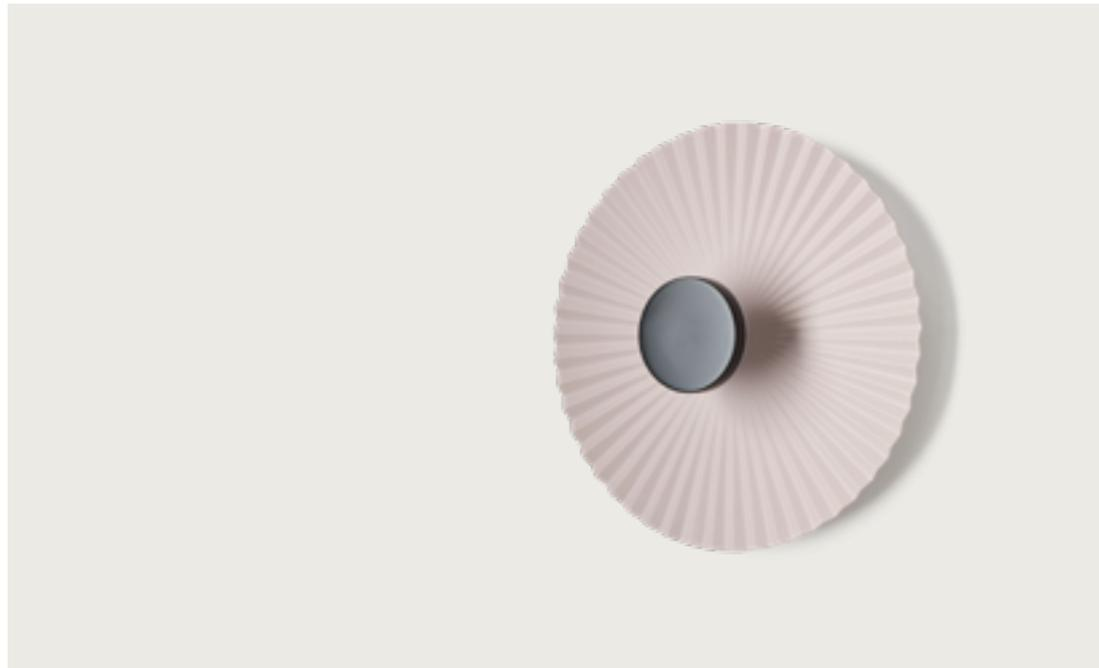

DESCRIPTION

MATERIALS

Steel / Resin

FINISHES

Metal:
Matt Brass
Black

Resin:
White

Image colour:
Pale pink
Hand painted

MODIFICACIONES POSIBLES

Check colour palette
Option to have it with E27

SPECIFICATIONS (UE)

Led integrated
TRIAC Dimmable
9W - 2700K
12V, 50/60Hz
IP20, Class I

ENERGY LABEL

A ++



MATERIALES

Acero / Resina

ACABADOS

Metal:
Oro Mate
Negro

Resina:
Blanca

Image colour:
Rosa palo
Pintada a mano

MODIFICACIONES POSIBLES

Consulta la paleta de colores
Opción de portalámparas E27

ESPECIFICACIONES (UE)

Led Integrado
Regulador TRIAC
9W - 2700K
12V, 50/60Hz
IP20, Clase I

ETIQUETA ENERGÉTICA

A ++

TECHNICAL

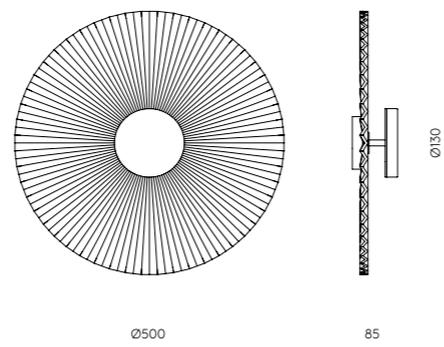

ALTUN

Wall lamp

A1120

Designed by Pepe Fornas, 2021

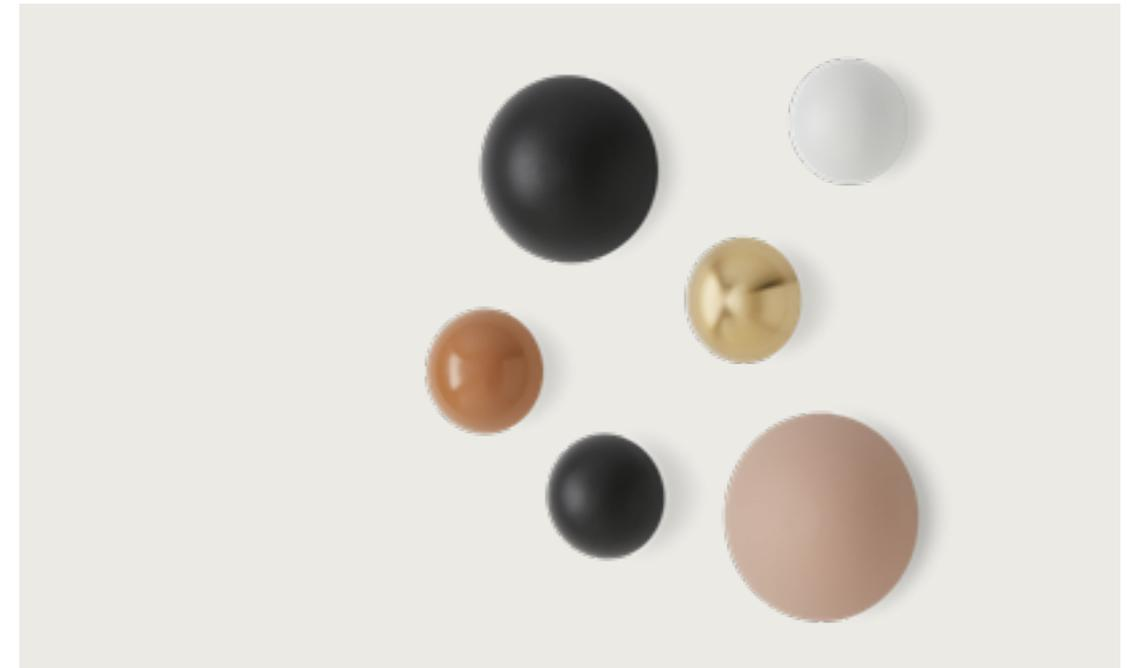

DESCRIPTION

MATERIALS

Steel

FINISHES

Canopy:
Matt White

Diffuser:
Matt Black
Matt white
Matt Gold

Other colors on page.432

SPECIFICATIONS (UE)

A1120/15
COB LED 9W-2700K
TRIAC Dimmable - IP20, Class I
220-240V - 24V, 50/60 Hz

A1120/22
COB LED 12W- 3000K
Dimmable - IP20, Class I
220-240V - 24V, 50/60 Hz

ENERGY LABEL

A ++



MATERIALES

Acero

ACABADOS

Florón:
Blanco mate

Difusor:
Oro Mate
Negro Mate
Blanco mate

Otros colores en pág.432

ESPECIFICACIONES (UE)

A1120/15
Placa LED 9W- 2700K
Regulable TRIAC- IP20, Clase I
220-240V - 24V, 50/60 Hz

A1120/22
Placa LED 12W- 3000K
Regulable - IP20, Clase I
220-240V - 24V, 50/60 Hz

ETIQUETA ENERGÉTICA

A ++

TECHNICAL

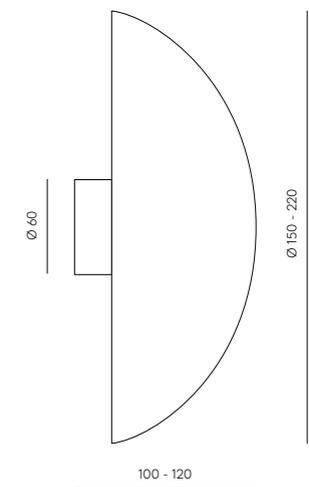

FIND

Wall lamp

A1110

Designed by AC Studio, 2010

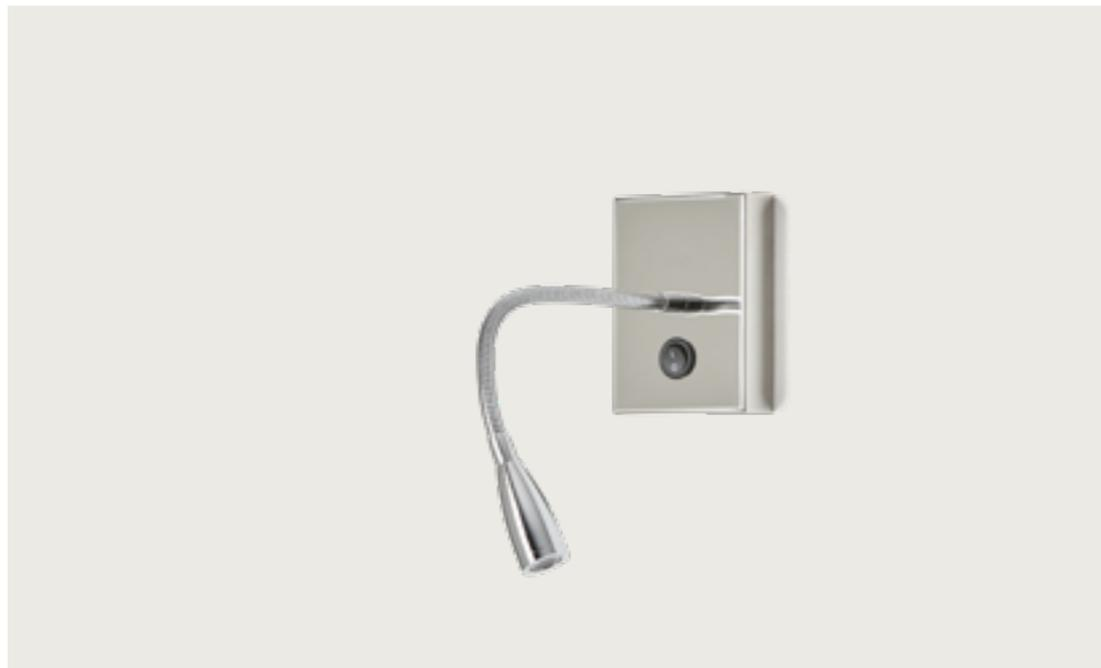

DESCRIPTION

MATERIALS

Steel / Fabric

FINISHES

Metal:
Chrome

RECOMMENDED BULB

B211 (7, 9, 11W)

SPECIFICATIONS (UE)

LED 3W - 3000K
12V, 50/60 Hz
IP20, Class I

ENERGY LABEL

A ++



TECHNICAL

MATERIALES

Acero / Pantalla Textil

ACABADOS

Metal:
Cromo

BOMBILLA RECOMENDADA

B211 (7, 9, 11W)

ESPECIFICACIONES (UE)

LED 3W - 3000K
12V, 50/60 Hz
IP20, Clase I

ETIQUETA ENERGÉTICA

A ++

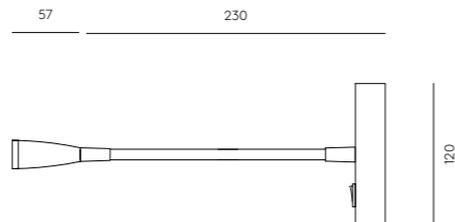

READ

Wall lamp

A1106

Designed by AC Studio, 2009



DESCRIPTION

MATERIALS

Steel / Fabric

FINISHES

Metal:
Chrome

Fabric:
White

SHADE INCLUDED

RECOMMENDED BULB

B211 (7, 9, 11W)

SPECIFICATIONS (UE)

E27 Max. 60W (Not included)
220-240 V, 50/60 Hz
IP20, Class I
Led 3W - 3000K - 270 lm (Incl)
12 V, 50/60 Hz, IP20, Class I

ENERGY LABEL

A ++



TECHNICAL

MATERIALES

Acero

ACABADOS

Metal:
Cromo

Textil:
Blanco

PANTALLA INCLUIDA

BOMBILLA RECOMENDADA

B211 (7, 9, 11W)

ESPECIFICACIONES (UE)

E27 Max. 60W (No incluida)
220-240 V, 50/60 Hz, IP20,
Clase I
Led 3W - 3000K - 270 lm (Incl)
12 V, 50/60 Hz, IP20, Clase I

ETIQUETA ENERGÉTICA

A ++

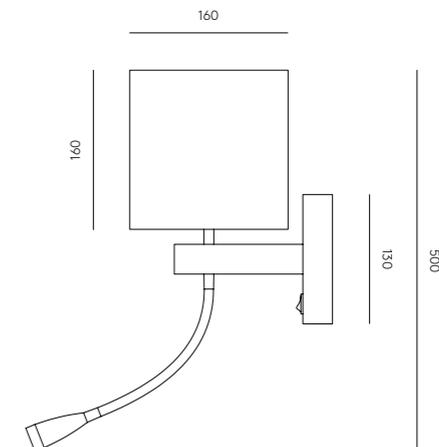

CROPI

A1100/56 · A1100/25

Designed by Pepe Fornas, 2017

DESCRIPTION

MATERIALS

Steel

FINISHES

Metal:
Aged Gold
Black

MEASUREMENTS

Diameter 250 mm
Diameter 560 mm

Colors in image:
A1100/56 Terracotta
A1100/25 Black

SPECIFICATIONS (UE)

E27 60 W Max (Not Included)
220-240 V, 50/60 Hz,
Ip20, Class I

ENERGY LABEL

A ++

⊕ IP20 CE 

MATERIALES

Acero

ACABADOS

Metal:
Oro Envejecido
Negro

MEDIDAS

Diámetro 250 mm
Diámetro 560 mm

Colores en imagen:
A1100/56 Terracotta
A1100/25 Negro

ESPECIFICACIONES (UE)

E27 60 W Max (No Incluida)
220-240 V, 50/60 Hz,
Ip20, Clase I

ETIQUETA ENERGÉTICA

A ++

TECHNICAL

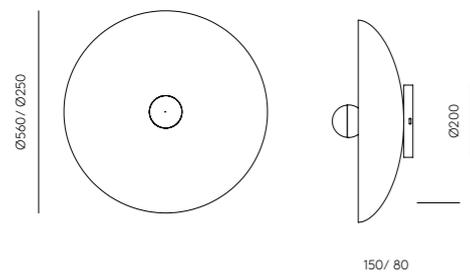



RANG

Wall lamp

A1093

Designed by JF Sevilla, 2022

DESCRIPTION

MATERIALS

Steel / Resin

FINISHES

Steel:
Matte Brass
Chrome

Resin:

White
Check colour palette

SPECIFICATIONS (UE)

Integrated led
9W - 2700K
TRIAC Dimmable
12V, 50/60Hz
IP20, Class I

ENERGY LABEL

A ++

MATERIALES

Acero / Resina

ACABADOS

Acero:
Latón Mate
Cromo

Resina:

Blanco
Consulta paleta de colores

ESPECIFICACIONES (UE)

Led integrado
9W - 2700K
Regulable TRIAC
12V, 50/60Hz
IP20, Clase I

ETIQUETA ENERGÉTICA

A ++

⊕ IP20 CE   

TECHNICAL

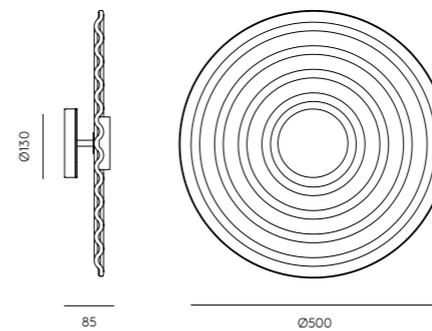

VASTER

Wall lamp

A1092

Designed by Pepe Fornas, 2017

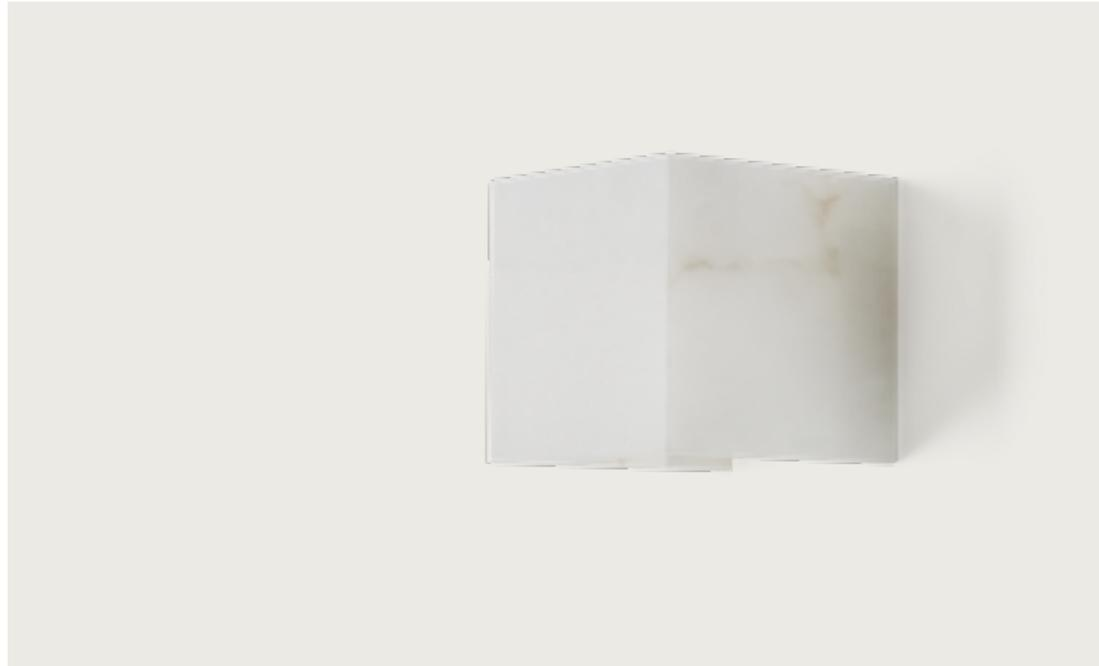

DESCRIPTION

MATERIALS

Steel / Alabaster

FINISHES

Metal:
Chrome

RECOMMENDED BULB
B005

SPECIFICATIONS (UE)

Bulb G9 5W 2700K (Included)
TRIAC Dimmable
220-240 V, 50/60 Hz
IP20, Class I

ENERGY LABEL

A ++



TECHNICAL

MATERIALES

Acero / Alabastro

ACABADOS

Metal:
Cromo

BOMBILLA RECOMENDADA
B005

ESPECIFICACIONES (UE)

Bombilla G9 5W 2700K (Incluida)
TRIAC Regulable
220-240 V, 50/60 Hz
IP20, Clase I

ETIQUETA ENERGÉTICA

A ++

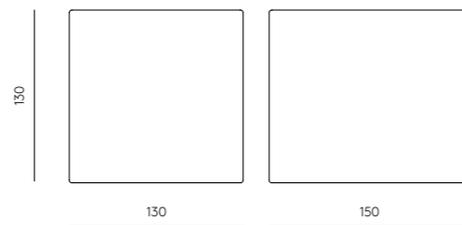

MINI ROSS

Wall lamp

A1063

Designed by JF Sevilla, 2015



DESCRIPTION

MATERIALS

Steel

FINISHES

Metal:
Shinny Gold
Matt Gold
Chrome
Matt Black

AVAILABLE SIZES

A1063/40 - 40CM
A1063/25 - 25 CM

RECOMMENDED BULB
B005

SPECIFICATIONS (UE)

3 x G9 LED Bulb (Included)
3W - 2700K
TRIAC Dimmable
220-240 V, 50/60 Hz
IP20, Class I

ENERGY LABEL

A ++



MATERIALES

Acero

ACABADOS

Metal:
Oro Brillo
Oro Mate
Cromo
Negro Mate

MEDIDAS DISPONIBLES

A1063/40 - 40CM
A1063/25 - 25 CM

BOMBILLA RECOMENDADA
B005

ESPECIFICACIONES (UE)

3 x Bombilla G9 Led (Incluida)
3W - 2700K
TRIAC Regulable
220-240 V, 50/60 Hz
IP20, Clase I

ETIQUETA ENERGÉTICA

A ++

TECHNICAL

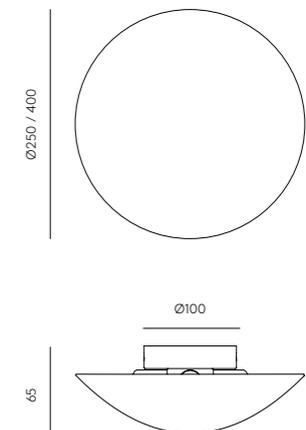

LASS

Wall lamp

A1053 + 1225

Designed by Fornasevi, 2022



DESCRIPTION

MATERIALS

Steel / Textured glass

FINISHES

Steel:
Bright Gold
Chrome
White
Black

SPECIFICATIONS (UE)

E27 Max. 60W
(Not included)
220-240V, 50/60Hz
IP20, Class I

ENERGY LABEL

A ++

IP20 CE

TECHNICAL

MATERIALES

Acero / Cristal texturizado

ACABADOS

Acero:
Oro Brillo
Cromo
Blanco
Negro

ESPECIFICACIONES (UE)

E27 Max. 60W
(No incluida)
220-240 V, 50/60 Hz
IP20, Clase I

ETIQUETA ENERGÉTICA

A ++

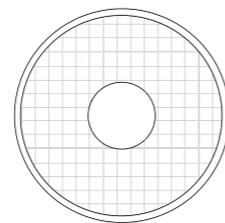

300 - 500

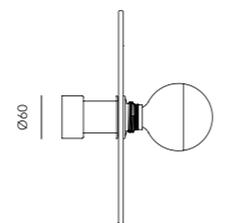

50 100 150 200 250



Bucharest, Romania

FEST

Wall lamp

A1053 + 1223

Designed by JF Sevilla, 2016



DESCRIPTION

MATERIALS

Steel / Alabaster

FINISHES

Steel:
Bright Gold
Chrome
White
Black

SPECIFICATIONS (UE)

E27 Max. 60W
(Not included)
220-240V, 50/60Hz
IP20, Class I

ENERGY LABEL

A ++



MATERIALES

Acero / Alabastro

ACABADOS

Acero:
Oro Brillo
Cromo
Blanco
Negro

ESPECIFICACIONES (UE)

E27 Max. 60W
(No incluida)
220-240 V, 50/60 Hz
IP20, Clase I

ETIQUETA ENERGÉTICA

A ++

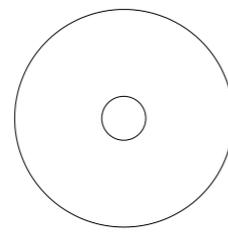

Ø150 / Ø250 / Ø350

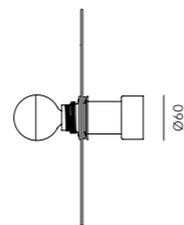

50 / 100 / 150 / 200 / 250

TECHNICAL

SPIDER

Wall lamp

A1053 + 1163

Designed by Fornasevi, 2013



DESCRIPTION

MATERIALS

Steel / Glass

FINISHES

Metal:
Shinny Gold
Chrome
White
Black

Glass:
Amber
Pink
Dark Blue
Turquoise
Brown

Image: Gold and amber

RECOMMENDED BULB

B038/GOLD

SPECIFICATIONS (UE)

E27 Max. 60W
(Not included)
220-240V, 50/60Hz
IP20, Class I

ENERGY LABEL

A ++



MATERIALES

Acero / Cristal

ACABADOS

Metal:
Oro Brillo
Cromo
Blanco
Negro

Cristal:
Ambar
Rosa
Azul Oscuro
Turquesa
Marrón

Imagen: Oro y ámbar

BOMBILLA RECOMENDADA

B038/ORO

ESPECIFICACIONES (UE)

E27 Max. 60W
(No incluida)
220-240 V, 50/60 Hz, IP20,
Clase I

ETIQUETA ENERGÉTICA

A ++

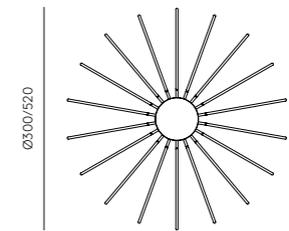

Ø300/520

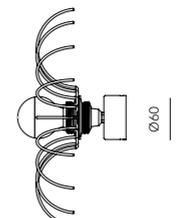

Ø60

147

LAOS

Wall lamp

A1053 + 1141

Designed by JF Sevilla, 2020



DESCRIPTION

MATERIALS

Steel / Natural Dried Grass

FINISHES

Metal: Shiny Gold / Chrome / White / Black

Wheel: Dried Grass

EACH PIECE SOLD SEPARATELY

Composition 3 pieces

AVAILABLE DIAMETERS

30 and 50 cm

RECOMMENDED BULBS

B035 (Ø95) B038 (Ø55)

SPECIFICATIONS (UE)

E27 Max. 60W (Not included)
220-240 V, 50/60 Hz,
IP20,, Class I

ENERGY LABEL

A ++



MATERIALES

Acero / Paja Natural

ACABADOS

Metal: Oro Brillo / Cromo / Blanco / Negro

Rueda: Paja Natural

SE VENDE POR SEPARADO

Composición de 3 piezas

DIÁMETROS DISPONIBLES

30 y 50 cm

BOMBILLAS RECOMENDADAS

B035 (Ø95) B038 (Ø55)

ESPECIFICACIONES (UE)

E27 Max. 60W (No incluida)
220-240 V, 50/60 Hz,
IP20,, Clase I

ETIQUETA ENERGÉTICA

A ++

TECHNICAL

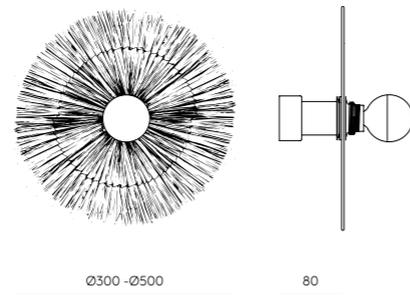

FLAT

Wall lamp

A1053 + 1135

Designed by AC Studio, 2023



DESCRIPTION

MATERIALS

Steel / Textile

FINISHES

Metal: Shiny Gold / Chrome / White / Black

AVAILABLE DIAMETERS

30, 60 y 90 cm

SPECIFICATIONS (UE)

E27 Max. 60W (bulb not included) 220-240 V, 50/60 Hz
IP20, Class I

ENERGY LABEL

A ++



MATERIALES

Metal / Textil

ACABADOS

Metal: Oro Brillo / Cromo / Blanco / Negro

DIÁMETROS DISPONIBLES

30, 60 y 90 cm

ESPECIFICACIONES (UE)

E27 Max. 60W (Bombilla no incluida) 220-240 V, 50/60 Hz
IP20, Clase I

ETIQUETA ENERGÉTICA

A ++

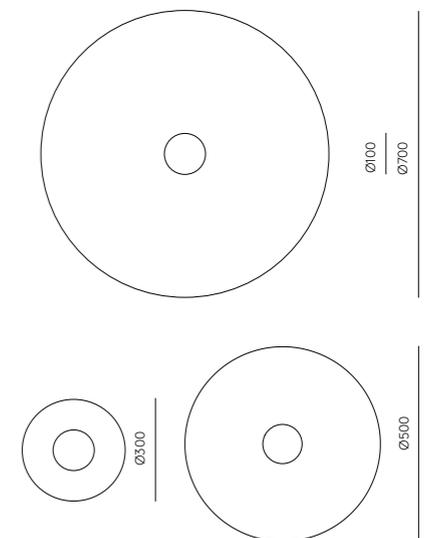



FLAT



TAN TAN

Wall lamp

A1053 + 1125

Designed by Fornasevi, 2018



DESCRIPTION

MATERIALS

Steel / Rattan

FINISHES

Metal:

Shinny Gold
Chrome
White
Black

Wheel:

Natural
Black

BULBS

B035 (Ø95) B038 (Ø55)

SPECIFICATIONS (UE)

E27 Max. 60W (Not included)
220-240 V, 50/60 Hz, IP20,
Class I

ENERGY LABEL

A ++



MATERIALES

Acero / Ratán

ACABADOS

Metal:

Oro Brillo
Cromo
Blanco
Negro

Rueda:

Natural
Negro

BOMBILLAS

B035 (Ø95) B038 (Ø55)

ESPECIFICACIONES (UE)

E27 Max. 60W (No incluida)
220-240 V, 50/60 Hz, IP20,
Clase I

ETIQUETA ENERGÉTICA

A ++

TECHNICAL

Ø300 / Ø600 / Ø900

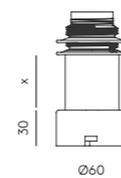
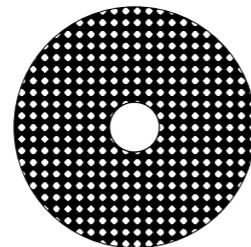

KASSY

Wall lamp

A1053 + 1097

Designed by Fornasevi, 2018



DESCRIPTION

MATERIALS

Steel / Ceramic

FINISHES

Metal:

Shinny Gold
Chrome
White
Black

DISC DIMENSIONS

200 - 300 MM

BULB IMAGE

B038/GOLD

SPECIFICATIONS (UE)

E27 Max. 60W (Not included)
220-240 V, 50/60 Hz, IP20,
Class I

ENERGY LABEL

A ++



MATERIALES

Acero / Cerámica

ACABADOS

Metal:

Oro Brillo
Cromo
Blanco
Negro

DIMENSIONES DISCO

200 - 300 MM

BOMBILLA IMAGEN

B038/ORO

ESPECIFICACIONES (UE)

E27 Max. 60W (No incluida)
220-240 V, 50/60 Hz, IP20,
Clase I

ETIQUETA ENERGÉTICA

A ++

TECHNICAL

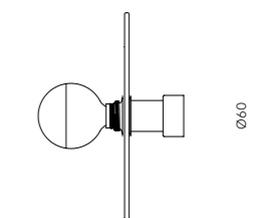
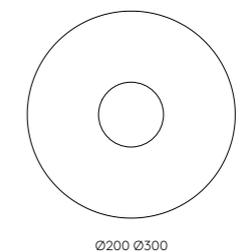

50 100 150 200 250

WAVE

Wall lamp

A1053 + 1094/30
Designed by Fornasevi, 2022



DESCRIPTION

MATERIALS

Steel / Alabaster

FINISHES

Steel:
Bright Gold
Chrome
White
Black

SPECIFICATIONS (UE)

E27 Max. 60W
(Not included)
220-240V, 50/60Hz
IP20, Class I

ENERGY LABEL

A ++

IP20 CE RoHS WEEE

TECHNICAL

MATERIALES

Acero / Alabastro

ACABADOS

Acero:
Oro Brillo
Cromo
Blanco
Negro

ESPECIFICACIONES (UE)

E27 Max. 60W
(No incluida)
220-240 V, 50/60 Hz
IP20, Clase I

ETIQUETA ENERGÉTICA

A ++

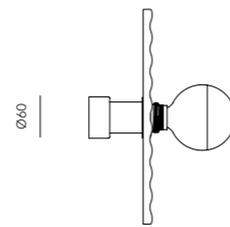
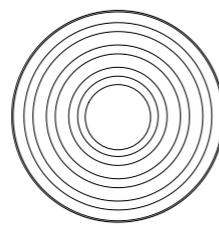

50 100 150 200 250



ALBA

Wall lamp

A1053 + 1096

Designed by JF Sevilla, 2019



DESCRIPTION

MATERIALS

Steel / Alabaster

FINISHES

Metal:
Shinny Gold
Chrome
White
Black

DISC DIMENSIONS

250 - 350 MM

BULB IMAGE

B038/GOLD

SPECIFICATIONS (UE)

E27 Max. 60W (Not included)
220-240 V, 50/60 Hz, IP20,
Class I

ENERGY LABEL

A ++



MATERIALES

Acero / Alabastro

ACABADOS

Metal:
Oro Brillo
Cromo
Blanco
Negro

DIMENSIONES DISCO

250 - 350 MM

BOMBILLA IMAGEN

B038/ORO

ESPECIFICACIONES (UE)

E27 Max. 60W (Not included)
220-240 V, 50/60 Hz, IP20,
Class I

ETIQUETA ENERGÉTICA

A ++

TECHNICAL

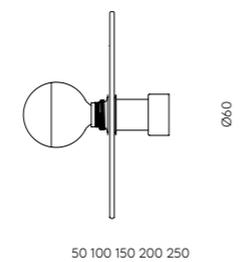
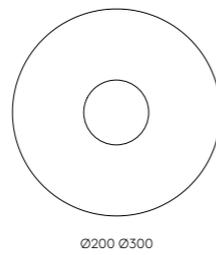

LINE

Wall lamp

A1053 + 1089

Designed by Fornasevi, 2018

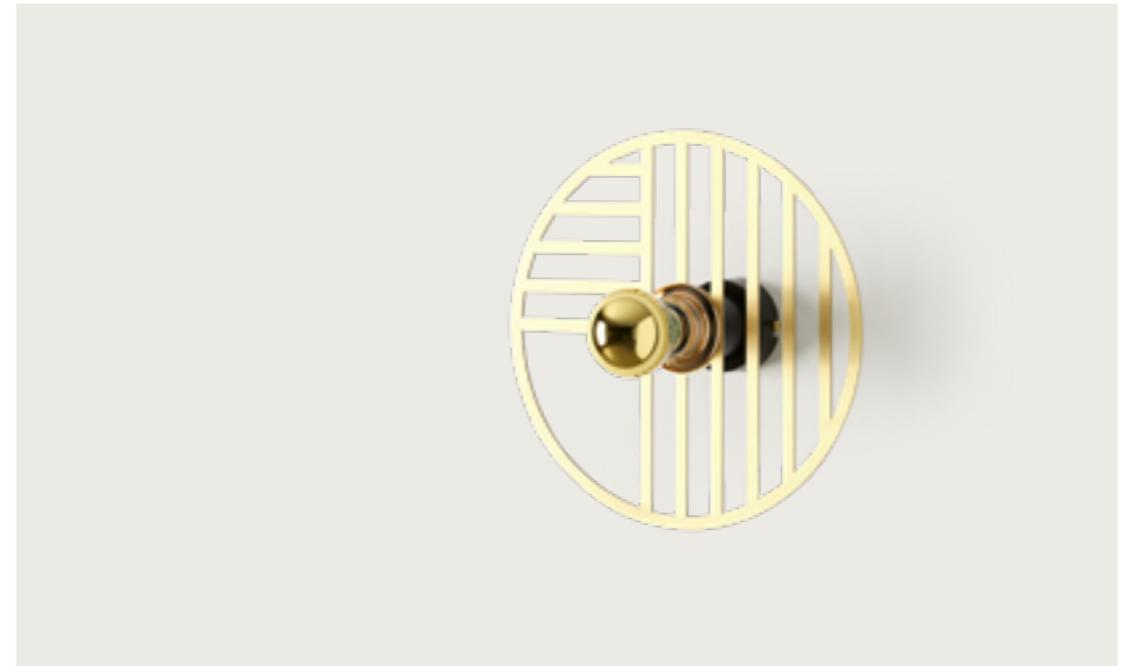

DESCRIPTION

MATERIALS

Steel / Ceramic

FINISHES

Metal:
Shinny Gold
Chrome
White
Black

DISC DIMENSIONS

200 - 300 MM

BULB IMAGE

B038/GOLD

SPECIFICATIONS (UE)

E27 Max. 60W (Not included)
220-240 V, 50/60 Hz, IP20,
Class I

ENERGY LABEL

A ++



MATERIALES

Acero / Cerámica

ACABADOS

Metal:
Oro Brillo
Cromo
Blanco
Negro

DIMENSIONES DISCO

200 - 300 MM

BOMBILLA IMAGEN

B038/ORO

ESPECIFICACIONES (UE)

E27 Max. 60W (No incluida)
220-240 V, 50/60 Hz, IP20,
Clase I

ETIQUETA ENERGÉTICA

A ++

TECHNICAL

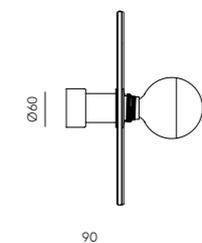
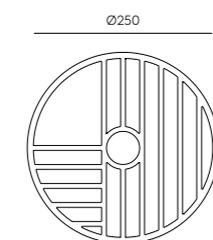

HABAN

Wall lamp

A1053 + 1088

Designed by JF Sevilla, 2019



DESCRIPTION

MATERIALS

Steel

FINISHES

Support:

Black
Gold
Chrome

Fans:

Image colors:
Pale pink, Make Up, White,
Mustard, Mexico Blue

Color palette on pg. 432

BULB IMAGE

B038/ORO (reflecting)
B033/COB (opal)

SPECIFICATIONS (UE)

E27 Max. 60W (Bulb not included)
220-240 V, 50/60 Hz
IP20, Class I

ENERGY LABEL

A ++



MATERIALES

Acero

ACABADOS

Soporte:

Negro
Oro
Cromo

Abanicos:

Colores en imagen: Rosa palo,
Maquillaje, Blanco, Mostaza y
Azul México

Paleta de colores en pág. 432

BOMBILLA IMAGEN

B038/ORO (espejada)
B033/COB (opal)

ESPECIFICACIONES (UE)

E27 Max. 60W (Bombilla no incluida)
220-240 V, 50/60 Hz
IP20, Clase I

ETIQUETA ENERGÉTICA

A ++

TECHNICAL

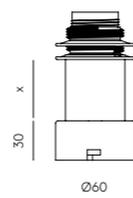
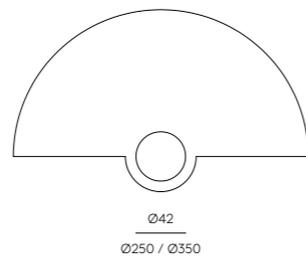

GHABAN

Wall lamp

A1053 + R1086/1086

Designed by Fornasevi, 2022

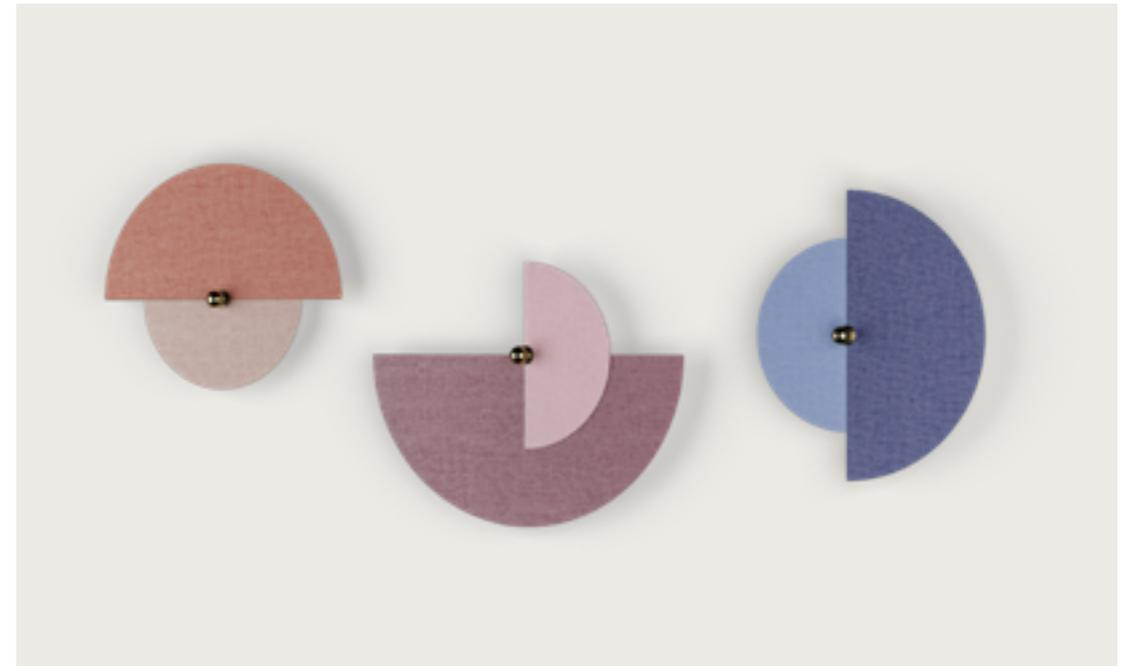

DESCRIPTION

MATERIALS

Steel / Fabric / Rattan

FINISHES

Steel:
Bright Gold
Chrome
White
Black

Fabrics:

Check color palette

SPECIFICATIONS (UE)

E27 Max. 60W
(Not included)
220-240V, 50/60Hz
IP20, Class I

ENERGY LABEL

A ++



MATERIALES

Acero / Textil / Ratán

ACABADOS

Acero:
Oro Brillo
Cromo
Blanco
Negro

Textil:

Consultar paleta de colores

ESPECIFICACIONES (UE)

E27 Max. 60W
(No incluida)
220-240 V, 50/60 Hz
IP20, Clase I

ETIQUETA ENERGÉTICA

A ++

TECHNICAL

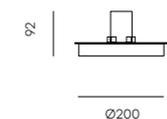
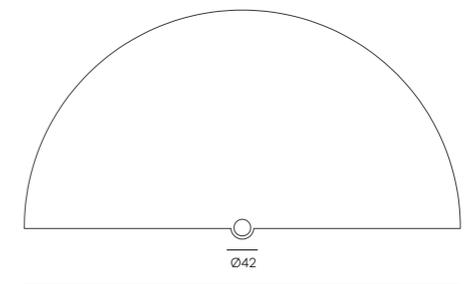

GHABAN

La Habana, Cuba





Accesorios

CATÁLOGO DE ACCESORIOS ACCESSORIES CATALOGUE

A continuación se ofrece nuestro catálogo de accesorios recomendados para su uso en nuestras luminarias.

Below is our catalog of recommended accessories for use in our lamps.

Para más información sobre pantallas y accesorios, por favor consulte nuestra tarifa a partir de la página 57.

For more information on screens and accessories, please see our price list starting on page 57



1038

MATERIAL
METAL

FINISH
GOLD
CHROME
BLACK
WHITE
MATT BRASS

SIZES
Ø150
Ø250
Ø350



R1052

MATERIAL
METAL

FINISH
GOLD
CHROME
BLACK
WHITE

SIZES
Ø300
Ø600
Ø900

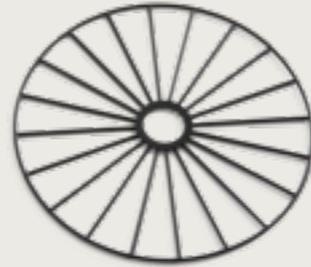

1096

MATERIAL
ALABASTER

FINISH
NATURAL

SIZES
Ø250
Ø350



1097

MATERIAL
CERAMIC

FINISH
CERAMIC

SIZES
Ø200
Ø300



1088

MATERIAL
METAL

FINISH
WHITE
BLACK
COLOR,
CONSULT US

SIZES
Ø250
Ø350



1089

MATERIAL
METAL

FINISH
GOLD
CHROME
BLACK
WHITE
MATT BRASS

SIZE
Ø250

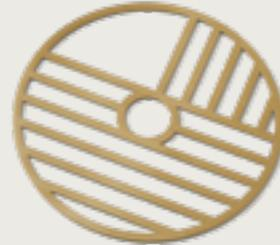

1125

MATERIAL
RATTAN

FINISH
NATURAL
BLACK

SIZES
Ø300
Ø600
Ø900



1132

MATERIAL
RESIN

FINISH
WHITE
BLACK
COLOR,
CONSULT US

SIZE
Ø500



1093/50

MATERIAL
RESIN

FINISH
WHITE

SEE COLOUR
PALLETTE

SIZES
Ø500



1094/30

MATERIAL
ALABASTER

FINISH
NATURAL

SIZES
Ø300



1141

MATERIAL
DRIED GRASS

SIZE
Ø300
Ø500



1143 / 1144

MATERIAL
BAMBOO

FINISH
NATURAL

SIZE
Ø400
Ø500



1160

MATERIAL
NATURAL FIBER

FINISH
BLACK

SIZE
Ø300
Ø600



1163

MATERIAL
METAL WIRE

FINISH
GOLD
CHROME
MATT BLACK
MATT WHITE

SIZES
Ø300
Ø520

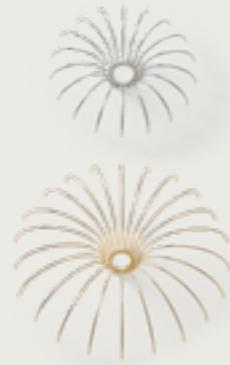

C1010

MATERIAL
METAL

FINISH
BLACK

SIZE
3M CABLE

BULB
E27



C1010

MATERIAL
METAL

FINISH
GOLD

SIZE
3M CABLE

BULB
E27



1215

DESCRIPCIÓN
Soporte para fijación de colgantes a pared

DESCRIPTION
Support for wall hanging fixing

SIZE
250MM



1223

MATERIAL
GLASS

FINISH
PINK
TURQUOISE
DARK BLUE
AMBER
BROWN

SIZE
Ø250



C1011

MATERIAL
METAL

FINISH
BRONZE

SIZE
3M CABLE

BULB
E27



C1012

MATERIAL
METAL

FINISH
BLACK

SIZE
3M CABLE

BULB
E27



1225

MATERIAL
GLASS

FINISH
TEXTURED

SIZE
Ø300
Ø500

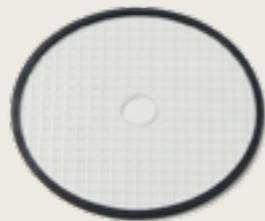

1289

MATERIAL
ALABASTER
METAL

FINISH
GOLD
CHROME
BLACK
WHITE
ALABASTER

SIZE
Ø150
Ø250
Ø350



A1053

MATERIAL
Metal

MATERIAL
Metal

ACABADOS
Oro Brillo
Cromo
Blanco
Negro

FINISH
Shinny Gold
Chrome
White
Black

DIMENSIONES (X)
5 cm
10 cm
15 cm
20 cm
25 cm

DIMENSIONES (X)
5 cm
10 cm
15 cm
20 cm
25 cm

BOMBILLA E27 **BULB E27**



CATÁLOGO DE BOMBILLAS BULBS CATALOGUE

A continuación se ofrece nuestro catálogo de bombillas recomendadas para su uso en nuestras luminarias.

Below is our catalog of recommended bulbs for use in our lamps.

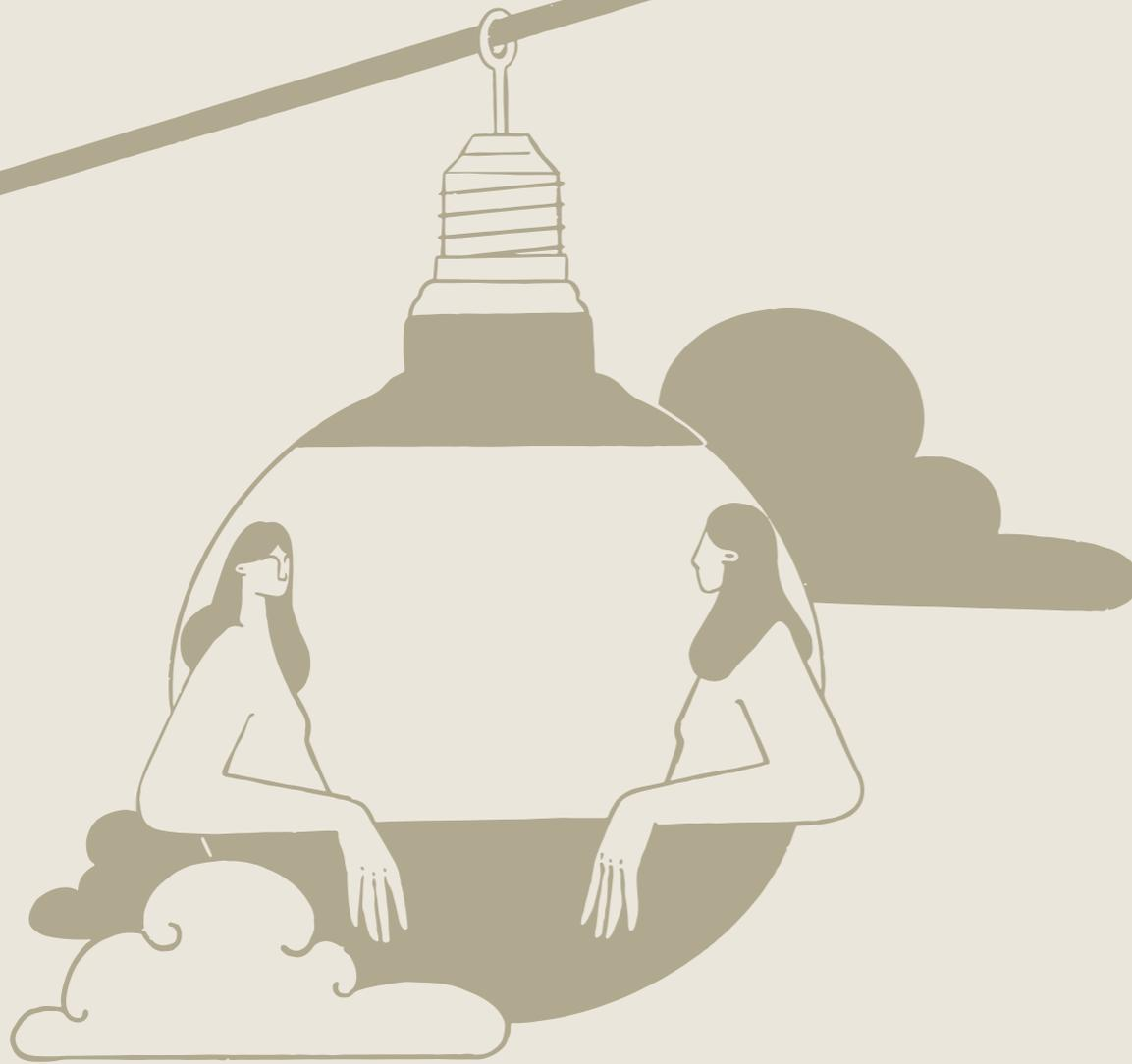

Bulbs

B223

E27
4W
420 lm
2700K



Ø45

B211

E27
7W / 750 lm / 3000K
9W / 810 lm / 2700K
11W / 990 lm / 3000K
Regulable / Dimmable



Ø60

B056

E27
3W
350lm
2700K



Ø125

B055

E27
3W
350lm
2700K



Ø230

B162

GU10
5W
420 lm
3000K / 5000K
Smart Wifi / CCT



Ø50

B161

GU10
5W
420 lm
3000K / 5000K



Ø50

B054

E27
3W
270 lm
2700K



Ø125

B053

E27
3W
270 lm
2700K



Ø125

B116-2

E14
5W
420 lm
3000K / 5000K



Ø45

B057

E27
3W
350lm
2700K



Ø60

B051

E27
3,8W
2700K
Control Wi-Fi



Ø95

B050

E27
2,5W
90 lm / 100 lm / 110 lm
2000K / 3000K / 4000K
Regulable / Dimmable



Ø64

B048

G200 E27
3W
2700K
Puntos Negros



Ø200 | 235

B047

G125 E27
3W
2700K

Puntos Negros



Ø125 | 155

B041

E27
COB 3W
350 lm
2700K



Ø165 | 110

B039

E27
6W
806 lm
2700K

Gold
Chrome



Ø125 | 170

B052

G95 E27
7W
806 lm
2700K

Opal



Ø95 | 130

B046

E27
3W
270lm
2700K



Ø80 | 140

B038

E27
4W
550 lm
2700K
Regulable / Dimmable

Gold
Chrome



Ø55 | 90

B037

E27
COB 3W
350 lm
2700K



Ø125 | 180

B043

E27
4W
130 lm
Led 1800K



Ø125 | 330

B042

E27
4W
130 lm
Led 1800K



Ø125 | 155

B035

E27
6W Led
806 lm
2700K

Gold
Chrome



Ø95 | 130

B034

E27
COB 3W
350 lm
2700K

Opal



Ø140 | 200

B033

E27
COB 3W
350 lm
2700K

Clear



B030

E14
4W
450 lm
2700K

Gold
Chrome



B019

E27
4W Led
300 lm
2200K



B015

E27
COB 3W
350 lm
2700K



B028

E27
COB 3W
350 lm
2700K

Clear



B027

E27
COB 3W
350 lm
2700K

Clear



B005

E27 - G9 - 3000k
3W -270lm
5W- 450 lm (opción regulable /
Dimmer option)
8W - 720 lm (regulable DALI Consultar /
Dimmable DALI Consult)



B004

E27
6W Led
450 lm
2700K



B023

E27
4W Led
300 lm
2700K
Regulable / Dimmable

Clear



B020

E27
4W Led
300 lm
2200K
Regulable / Dimmable



B003

E27
6W Led
450 lm
2700K



Finishes

COLORES DE CRISTALES COLOR GLASS



PALETA DE COLOR MÁRMOL MARBLE COLOR PALETTE

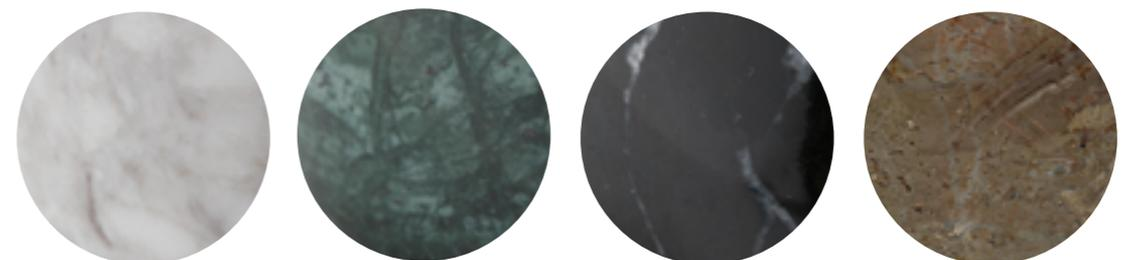

PALETA DE COLOR CERÁMICA, VIDRIO Y METAL

COLOR PALETTE CERAMICS, GLASS & METAL

Los colores de la paleta son aproximados.
Consultar los códigos en la carta RAL o NCS.

The colors in the palette are approximate.
Consult the RAL or NCS references.

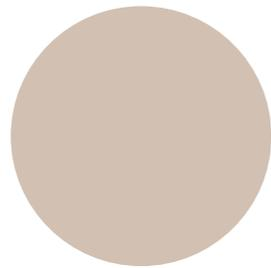

NUDE
NCS S2010Y50R

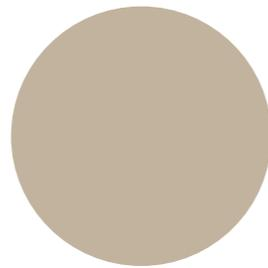

SILHOUETTE
NCS S2809Y01R

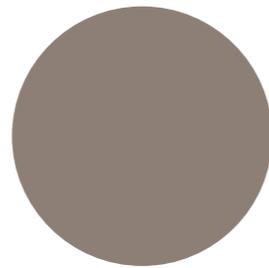

**VINTAGE BROWN /
MARRÓN VINTAGE**
NCS S5505Y46R

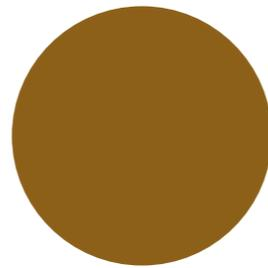

**HONEY /
MIEL**
NCS S5040Y10R

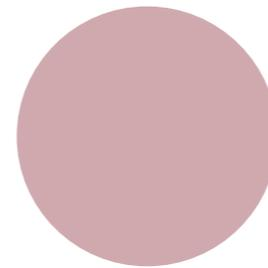

**ROSA PALO /
PALE PINK**
NCS S2010R10B

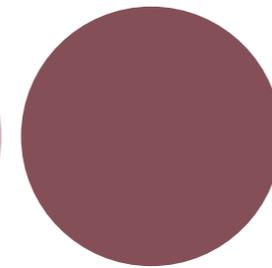

**MINERAL RED /
MINERAL ROJO**
NCS S5030R10B

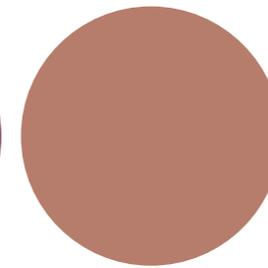

**MAQUILLAJE /
MAKE UP**
NCS 3020Y70R

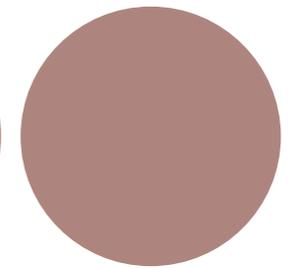

**DESERT RED /
ROJO DESIERTO**
NCS S3020Y90R

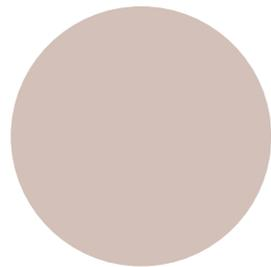

**TAUPE /
TOPO**
NCS 2005Y60R

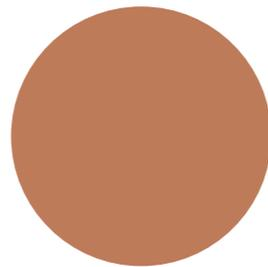

NATURAL CLAY
NCS S3932Y40R

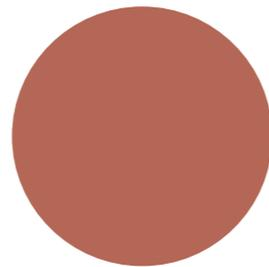

TERRACOTTA
NCS S4030Y70R

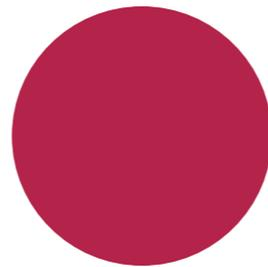

VIVA MAGENTE
NCS S2060R10B

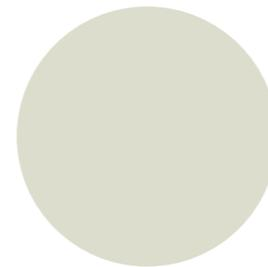

**MOLA GREEN /
VERDE MOLE**
NCS S2206G70Y

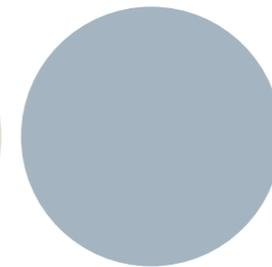

**MEXICO BLUE /
AXUL MÉXICO**
NCS S3010B10G

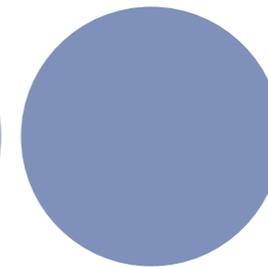

**OPAL VIOLET /
VIOLETA OPALINO**
NCS S3030R70B

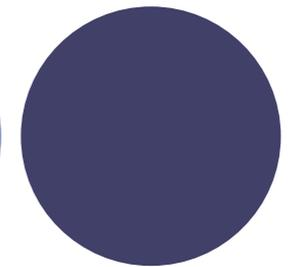

**PETROL BLUE /
AZUL SOMBRÍO**
NCS S6030R60B

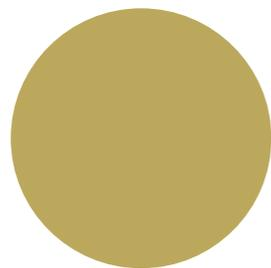

BANANA GREEN
NCS S2030G90Y

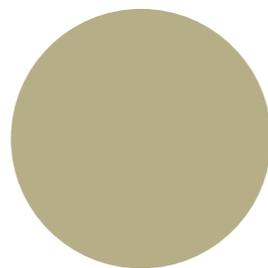

**SAND BROWN /
ARENA MARRÓN**
NCS S3020G50Y

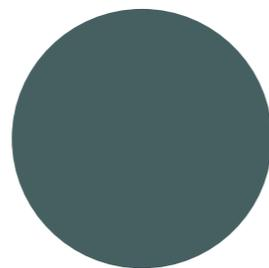

**HUNT GREEN /
VERDE HUNT**
NCS S6530B50G

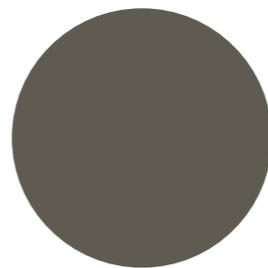

**GREEN LEAF /
VERDE HOJA**
NCS S7005G80Y

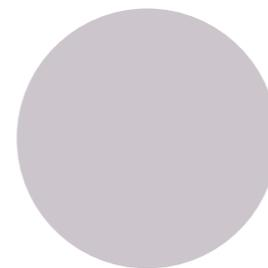

**LIGHT VIOLET /
VIOLETA CLARO**
NCS S1510R40B

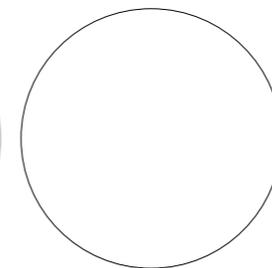

**BLANCO /
WHITE**

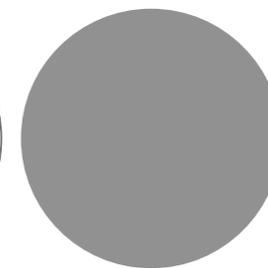

**GRIS CENIZA /
ASH GREY**
NCS S4000N

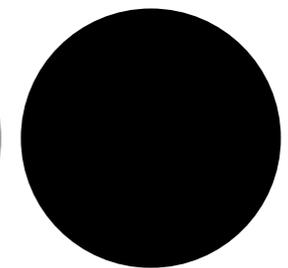

**NEGRO /
BLACK**

Information

INFORMACIÓN GENERAL GENERAL INFORMATION

Las descripciones y medidas de los productos del presente catálogo son orientativas, pudiendo por tanto ser modificadas, a fin de mejorar las características técnicas o de diseño. La empresa se reserva el derecho de anular o modificar cualquier modelo sin previo aviso. Todos los modelos cumplen las normas exigidas por la CE para iluminación de uso doméstico y sus características vienen determinadas por las clase 1 y la clase 2. Los acabados y las especificaciones técnicas corresponden a los productos que se suministran en Europa, pudiendo estos variar en otros mercados. Para una buena conservación de las lámparas, no usar bombillas de potencia superior a las recomendadas y limpiar solamente con un paño seco. No usar limpiametales ya que dañan los barnices protectores que garantizan la duración del acabado.

The descriptions and dimensions of the items in this catalogue are indicative and may be modified for the purpose of technical or design improvements. We reserve the right to cancel or change all models without prior notice. All items meet the CE Class 1 and class 2 safety regulations for home lighting appliances. The finishings and technical specifications listed here are for the European market and may vary elsewhere. Do not use stronger bulbs than recommended, and always clean lamps with a soft dry cloth. Metal polish will damage the protective finishings.

IMÁGENES IMAGES

Algunas imágenes mostradas en este catálogo corresponden a renders y son susceptibles de tener ligeros cambios en medidas y acabados respecto al producto final.

Some images shown in this catalogue correspond to renders and are likely to have slight changes in measurements and finishes with respect to the final product.

ICONOS ICONS

-  Tipo I
Class I
-  Tipo II
Class II
-  Tipo III
Class III
-  Reciclabre
Recyclable
-  Aparato electrónico no reciclable
Non-recyclable Electronic device
-  Certificación Europea
European Certification
-  Ajustable
Adjustable
-  Ajustable izquierda - derecha
Adjustable left - right
-  Ajustable arriba - abajo
Adjustable up - down
-  Bombilla incluida
Bulb included
-  Bombilla no incluida
Bulb not included
-  Bombilla no reciclable
Non-recyclable bulb
-  Clase energética
Energy class
-  Regulador de intensidad
Dimmer
-  Se enciende al tocar
Touch active
- IP20** Protección frente a sólidos de tamaño superior a 12mm y ninguna protección de líquidos
Protection against solids larger than 12mm and no protection from liquids

CONDICIONES GENERALES

1. PRECIOS

- 1.1. Los indicados en esta tarifa, son sin IVA ni recargo de equivalencia que proceda.
- 1.2. Los precios de las lámparas no incluyen bombillas o pantallas, salvo que este indicado lo contrario.
- 1.3. Esta tarifa de precios anula todas las anteriores.

2. PEDIDOS

- 2.1. Es imprescindible enviar los pedidos o modificaciones por correo electrónico, no se aceptarán pedidos por teléfono o modificaciones.

3. CONDICIONES DE PAGO

- 3.1. La forma de pago general es pago anticipado. En el caso de cambio de pago a giro o similar, el cliente deberá remitir con su firma y sello el formulario de domiciliación SEPA.
- 3.2. En las cuentas de los clientes con riesgo comercial aprobado, las condiciones particulares de pago, se acordarán individualmente con el responsable comercial de cada zona, y serán aprobadas por el departamento financiero.
 - 3.2.1 En ningún caso excederán los siguientes límites:

Vencimiento 45 días con giro bancario domiciliado se aceptan días de pago fijos a propuesta del cliente. Para aquellos clientes que no puedan aceptar cargos por GIRO bancario, la forma de pago máxima será transferencia o pagará a 30 días. Se aceptan días de pagos fijos a propuesta del cliente.
- 3.3. Los pedidos de proyectos que por su volumen deban ser fabricados, se deberá abonar un 30% o 50% del valor del pedido, como confirmación e inicio de producción.
- 3.4. El cliente no está autorizado a deducir, de los vencimientos, ningún importe en concepto de reclamación. A menos que les hayamos autorizado a ello por escrito.
- 3.5. En el caso de impagos, AROMAS se reserva el derecho de no aceptar o enviar pedidos hasta desbloquear la cuenta nuevamente.

4. CONDICIONES DE TRANSPORTE

- 4.1. Los pedidos superiores a 350€ netos se enviarán a portes pagados a territorio nacional. Para pedidos de importes inferiores, los portes se cargarán en factura con un mínimo de 9€ o el 7% del valor de la mercancía. En el caso de Portugal, los portes pagados son por pedidos superiores a 600€ netos. Para pedidos de importes inferiores, los portes son de 30€.
- 4.2. Los portes de los pedidos solicitados por transporte urgente, serán a cargo del cliente, previa aceptación del mismo, sea cual sea su importe.

5. INCIDENCIAS DEL TRANSPORTE

- 5.1. Si se produce alguna anomalía, daños visibles, embalaje dañado o se intuyen daños ocultos, deberá hacerse constar por escrito en el albarán del transporte, en el momento de la recepción de la mercancía. Además, se debe notificar a Aromas del Campo, en las 24h posteriores a la entrega, vía correo electrónico, incluyendo copia del albarán y fotos.

6. REPARACIONES

- 6.1. El presupuesto de reparación se realizará una vez la lámpara está en fábrica.
- 6.2. Los portes de las mercancías que se desea reparar serán a cargo del cliente.
- 6.3. Las lámparas que hace más de un año que están des-catalogadas, se puede solicitar el envío con cargo de recambio de las piezas en el caso de que estén disponibles.

7. DEVOLUCIONES

- 7.1. Solo se admiten devoluciones causadas por incidencia de producto y que haya sido autorizado previamente por Aromas del Campo.
- 7.2. Las devoluciones deben enviarse con su embalaje original, de lo contrario nuestro almacén rechazará la entrada de la mercancía.
- 7.3. Una vez verificado el producto por nuestro dpto. de calidad, en el caso de no conformidad, se cargará al cliente los gastos de reenvío y los recargos que se estimen oportunos. Pudiendo aplicar hasta un 15% de penalización en concepto de reembalaje.

8. VENTA ONLINE

- 8.1. Para poder ser distribuidor autorizado a vender y publicar luminarias de AROMAS DEL CAMPO a través del sitio web, es imprescindible haber firmado el acuerdo de venta Online.
- 8.2. Cualquier producto de AROMAS DEL CAMPO que se desee poner en soporte WEB debe cumplir unas condiciones de inserción.

9. CONDICIONES GENERALES

- 9.1. AROMAS DEL CAMPO se reserva el derecho a efectuar cualquier modificación y anulación de los productos del catálogo y la tarifa vigente sin preaviso alguno.
- 9.2. El cliente declara conocer y aceptar las condiciones de venta aquí descritas.

GENERAL CONDITIONS

1. PRICES

- 1.1. The given prices are the suggested retail prices without VAT.
- 1.2. The pricing do not include bulbs or shades except when mentioned.
- 1.3. This Price list nullify any other Price list.

2. ORDERS

- 2.1. All orders must be sent via email with reference codes, names, colors and if shades and bulbs are needed.

3. PAYMENT TERMS

- 3.1. All orders must be paid in advance by wire transfer with proforma number in description..
- 3.2. In case of orders that require customized products or for projects orders, the company will require total payment or 50% advanced payment.
- 3.3. Payment delays for holidays or festivities will not be accepted.
- 3.4. The delivery date is determined by the circumstances from the date in which the proforma is paid.
- 3.5. The client is not authorized to claim any incident if it is not in writing.
- 3.6. The company reserves right to deny orders if the client does not comply with payment commitments.

4. TRANSPORTATION

- 4.1. Transportation costs are calculated according to order and destination.
- 4.2. If client requires urgent shipment, additional costs will be applied.

5. CLAIMS

- 5.1. Any visible damage in packaging must be notified to shipping company upon receipt.
- 5.2. Claims will be accepted 5 working days after receiving order.
- 5.3. Claims must be sent via email to account manager with photos and description. If the above points are not met, the claim can be disqualified.
- 5.4. Claims will be accepted 5 working days after receiving order.
- 5.5. Damage claims are not included except if proved to be manufacturing flaw by AROMAS DEL CAMPO.

6. REPAIRS

- 6.1. If a third party wishes to repair a product before being returned to factory, it must be authorized by AROMAS DEL CAMPO.
- 6.2. The product must be packed correctly and in the original box.
- 6.3. Once the product is received in factory, an approximate price to repair will be issued.
- 6.4. Transportation costs will be covered by client.
- 6.5. In case the lamp has been discontinued, it can be repaired if the company has spare parts.
- 6.6. All repairs will be charged.

7. RETURNS

- 7.1. All returns must have approval by company, including claim cases.
- 7.2. For defective products, shipping company authorized by AROMAS will pick up correctly packed box.
- 7.3. We reserve right to charge additional repair costs if the returned package is damaged.
- 7.3. After product examination concludes that complaint was not justified, the company reserves right to charge extras.

8. WEB

- 8.1. In order to sell or publish any AROMAS DEL CAMPO product on the internet, an agreement must be signed.
- 8.2. The display of photographs of products or similar to AROMAS DEL CAMPO in websites must have specified authorization by the company.

9. GENERAL CONDITIONS

- 9.1. AROMAS DEL CAMPO reserves right to modify, without notice, prices in current catalogue and discontinue products.
- 9.2. Printing errors reserved.
- 9.3. Delivery dates are not complaining, AROMAS DEL CAMPO will attempt to fulfill them, however, cannot be held accountable under any case.
- 9.4. Discount rates can be modified at any moment.
- 9.5. Services offered by any company related to AROMAS DEL CAMPO distribution of products; like replacement of lamps, components, shipping of tester products, are covered by AROMAS DEL CAMPO.
- 9.6. All products are property of AROMAS DEL CAMPO until complete claim settlement.
- 9.7. Client accepts the conditions mentioned in this document.
- 9.8. AROMAS DEL CAMPO reserves right to declare a client account null if commercial agreement terms are not met.

AROMAS DEL CAMPO

Pol. Ind. l'Horta Vella
Calle 7 Parcela 3
46117 Bétera - Valencia - Spain

CONTACT

T. +34 962 737 953
M. aromas@aromasdelcampo.com
W. aromasdelcampo.com

PROJECT DIRECTION

ángelsegurafoto<

CONCEPT & ART DIRECTION

PerezOchando

PHOTOGRAPHY

ángelsegurafoto<

PRINTED BY

Libecrom

© AROMAS DEL CAMPO SL 2023

